

# CAR SHOCK ABSORBERS

CATALOGUE 2019 - 2020





# KONI CAR SHOCK ABSORBER PROGRAM

Welcome to KONI, one of the world's leading manufacturers of shock absorbers. This catalogue gives an overview of the many possibilities for customization and personalization of your car. Ever since 1955, KONI has held a prominent position in motor sports with its range of state-of-the-art shock absorbers and sport kits. All rely on KONI's longstanding experience!

TABLE OF CONTENTS

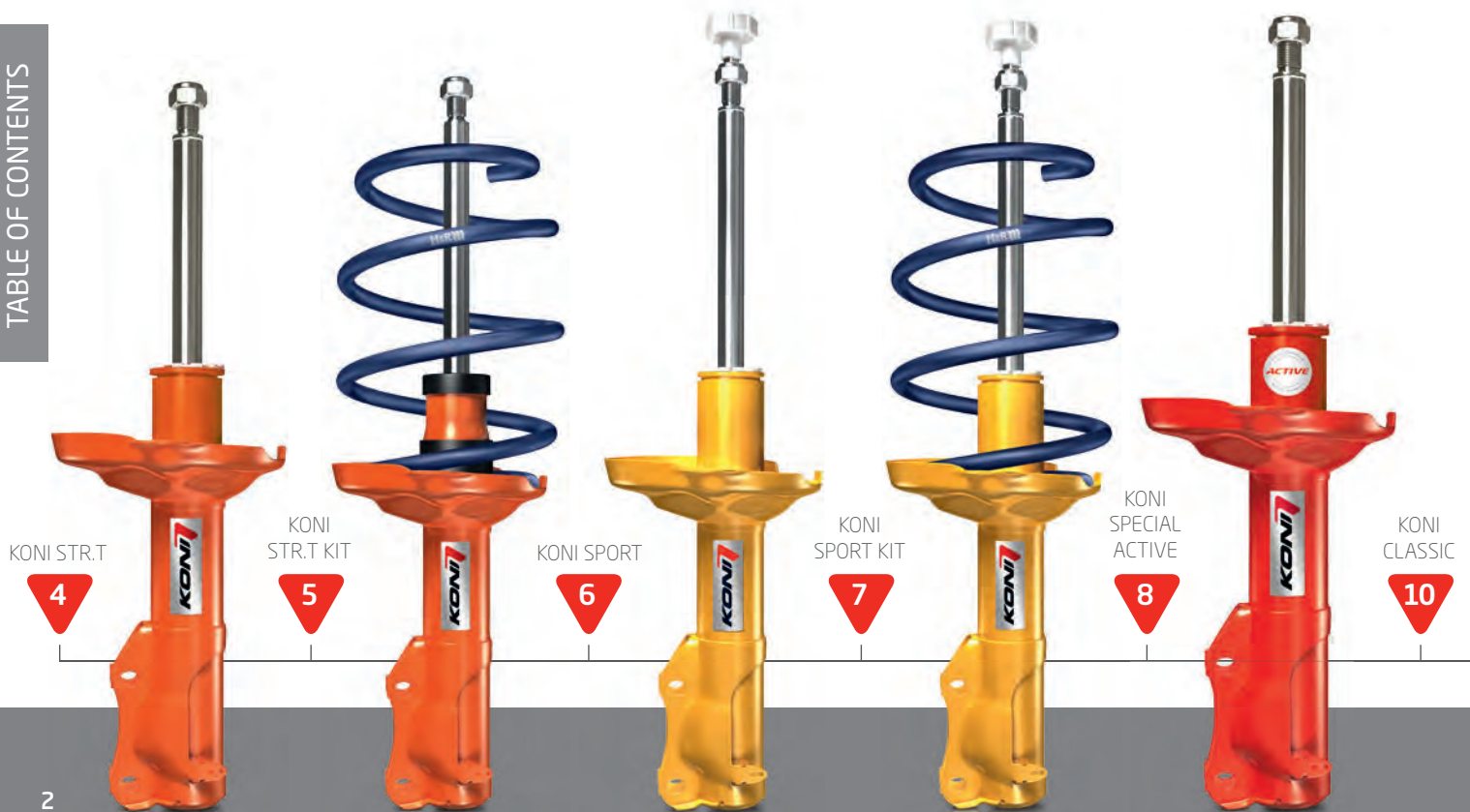



KONI  
COIL-OVER

11



KONI | H&R  
TRACKDAY KIT

12



KONI  
HEAVY  
TRACK

13



KONI RAID

13



Adjustment  
Procedures

14

Alphabetical  
Section

20

Numerical  
Section

92



# STR.T

## TUNED PERFORMANCE DAMPING AFFORDABLY PRICED

- Entry-Level Performance Shocks and Struts
- Product Complements Stock or Performance Lowering Springs
- Perfect for OE Replacement or Vehicle Improvement
- Non-Adjustable Damping

KONI's entry-level performance STR.T (pronounced "street") shocks and struts bring improved handling and KONI quality to the budget-minded driving enthusiast. Whether to simply refresh and upgrade a stock vehicle, or to match with street performance lowering springs and other modifications, KONI STR.T provides performance at a value price point.

STR.T Damping Force Comparison

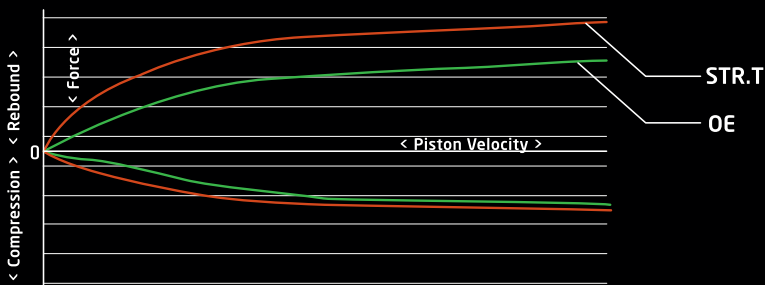



# STR.T KIT

---

## PERFORMANCE LOWERING & HANDLING UPGRADE ONE PURCHASE, ONE INSTALLATION

- Perfectly Tuned Chassis / 100% Performance
- Excellent Handling
- Lowering up to 40mm with H&R spring
- Perfect Match
- 100% Street Legal

The STR.T Kit from KONI comprises KONI STR.T shock absorbers and custom-made lowering springs from the company H&R. KONI's STR.T shock absorbers give you perfect road holding, optimum handling and breathtaking forces. Thanks to the extremely high reaction speeds of the shock absorbers, drivers can totally rely on their equipment, even in precarious or demanding situations.





# SPORT

LEGENDARY HANDLING CONTROL  
EXTERNAL REBOUND DAMPING ADJUSTMENT ON MOST CARS

- Streetable Ride Quality and Corner Carving Handling Control
- Excellent Choice for Multi-Use Cars (Street, Track, etc.)
- Best KONI Shock for All Performance Lowering Springs
- Double Adjustable and Race Valved Versions Available for Key Applications

KONI Sport struts and shocks are the industry leader for user-adjustable damping for daily drivers to weekend warriors. For decades, KONI Sport's familiar yellow color has meant superior motion control and adjustability for the discerning driving enthusiast.



SPORT Damping Force Comparison

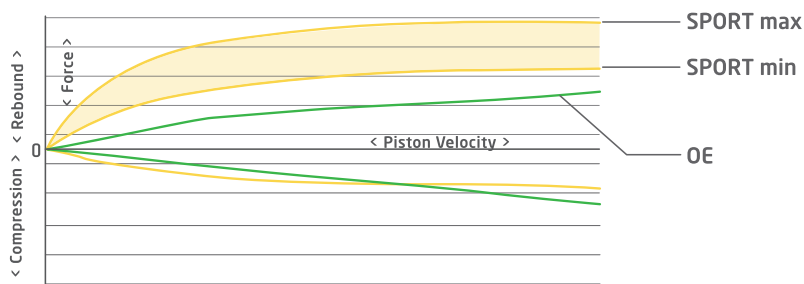



## SPORT KIT

---

### MATCHED ADJUSTABLE DAMPERS & LOWERING SPRINGS PERFORMANCE SUSPENSION EXCELLENCE IN ONE BOX

- Optimized Street or Track Performance
- Aggressive Roadholding and Improved Safety
- Engineered Kits for Specific Vehicle Applications
- Complete shocks kit consisting of four KONI high-performance car shock absorbers and matching lowering springs.

Are you a tuner? Do you like high speed? Are you impressed by professional skills and a dynamic sporting driving style? Then we have the right tool for you!

Our Sport shocks kit provides the ultimate shock absorber technology by KONI. This means that you can have even better roadholding, less chassis movement and performance support without limits. Show what you've got and experience the unique driving dynamics with optimum safety!

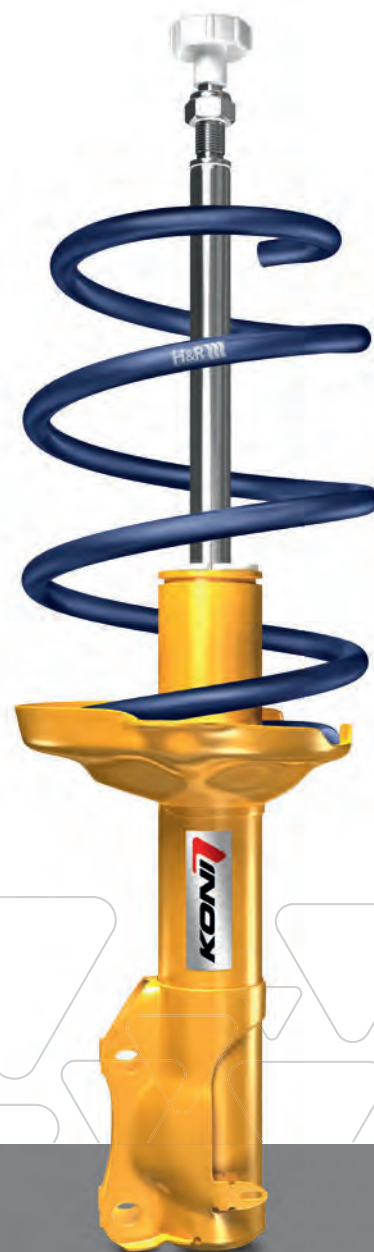



# SPECIAL ACTIVE

JUST AS A CHAMELEON ADAPTS TO ITS ENVIRONMENT, KONI SPECIAL ACTIVE TRANSFORMS TO SUIT VARIOUS ROAD CONDITIONS, INSTINCTIVELY.

KONI Special ACTIVE is the next generation of premium shock absorbers that offer superior handling without compromise. It is the latest advancement in the KONI product portfolio. Utilizing the most recent generation of KONI's patented Frequency Selective Damping technology, it controls large body motions and cornering forces but smooths expansion joints and rough roads for improved comfort.



Special ACTIVE Damping Range

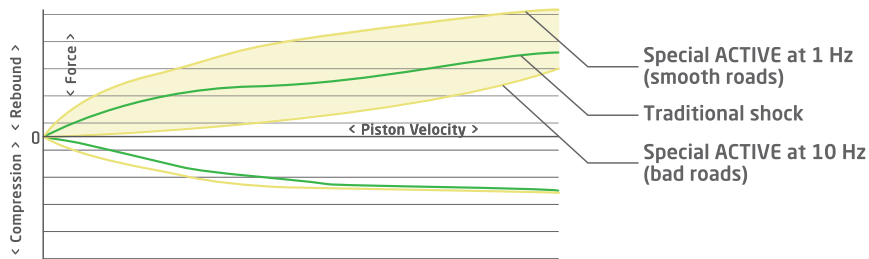





# IMPROVE HANDLING WITHOUT COMPROMISING COMFORT

---

- Special Active Applications Utilize Koni's Latest Generation of Frequency Selective Damping Technology
- Improves Safety and Road Holding
- Technology Proven on Over 1.5 Million Factory Equipped Vehicles
- Secure and Stable Feeling for Spirited Driving
- Unrivaled Aftermarket Solution can be Fitted to Most New and Older Cars
- Driving Refinement for Cars, Trucks, SUVs, etc.
- Technology that Rivals Expensive Original Equipment Electronic Systems
- Performance for Driver and Comfort for Passengers in One





## SPECIAL & CLASSIC

IMPROVED RIDE AND HANDLING PERFORMANCE  
REBOUND DAMPING ADJUSTABLE

- The Shocks That Earned KONI's World-Class Reputation
- Red (Special), Black or Red with KONI Winged Logo (Classic)
- Broad Application Range Including Older Performance Cars
- Use for Replacement and Vehicle Upgrade

KONI Special and Classic shock absorbers are available for many older performance cars. KONI selects the most appropriate damper technology and develops every shock absorber specifically for each application to bring out the best possible ride and handling. KONI Special and Classic continue to be the industry standard for older performance cars.





# COIL-OVER KITS

## RIDE HEIGHT AND REBOUND ADJUSTABLE TUNED PROGRESSIVE SPRINGS

- Threaded Bodies Offer 25-65mm Lowering Range
- Lowering can be Corner-Specific for Weight Jacking and Corner Balancing
- External Rebound Damping Adjustment on Most Cars
- Plated Shock Bodies, Grey Metallic Springs, and Red Anodized Spring Seats

KONI Coil-Over kits match the world-class KONI Sport adjustable valving with progressive lowering springs, ride height adjustable perches, and threaded bodies. Each application is specifically tailored to provide great handling and a large ride height adjustment range with a good streetable ride quality.

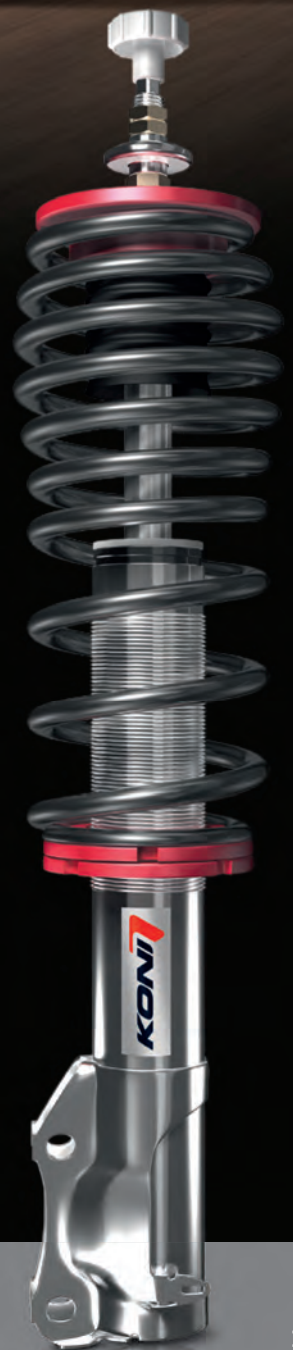

**COIL-OVER Damping and Force Comparison**

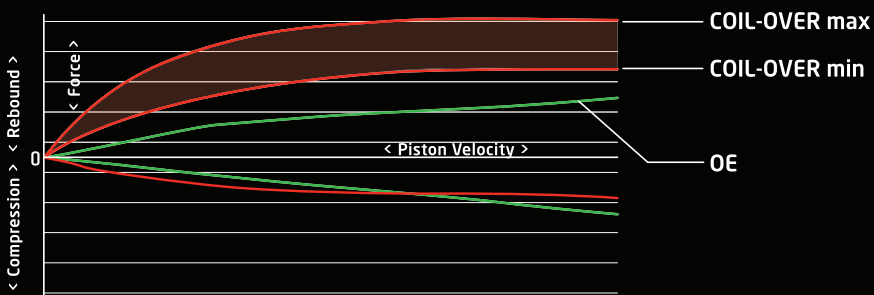



# KONI | H&R TRACK DAY KIT

---

## F1 TECHNOLOGY TAKES YOU TO THE LIMIT

- Aluminum Top Mount with Scalable Camber Adjustment
- Fully Independent Rebound and Bump Adjustability
- No Need for a Remote Reservoir

In the early 90's KONI introduced a new damper technology in Formula 1, which has since been used in many other race classes. This technology is still being used today in F2, GP3, Formula 3 and many other GT Series. KONI is now introducing this F1 technology in the KONI | H&R TRACK DAY KIT: perfect for track days as well as for fast road use.

When deciding which strut design to be used for the TrackDay kit suspension, KONI has chosen the up-side-down configuration of a mono tube damper. This configuration allows a very high side load, combined with a very solid damper setup; a must when it comes to real race dampers. The KONI mono tube dampers offer eight adjustment positions in both rebound as well as bump, which are all easily adjustable and felt by distinct stops, or clicks, to assure that each port in the valve preloaded port system can only be either open or closed. Each of these positions will give a noticeable and repeatable damper curve change. The wide adjustment range gives you the option to tune your car to the maximum setup for both road as well as track day use in a matter of seconds!





# HEAVY TRACK & RAID

## ROBUST CONSTRUCTION

## IMPROVED ROAD HOLDING

- KONI Special Technology, Up-Sized for Light Trucks and SUVs
- RAID: Extreme Durability Proven in The World's Toughest Conditions
- Heavy Track: Improved Handling and Ride for Big Vehicles
- Mono-Tube or Twin-Tube Design Based on Application
- Made in KONI factories with KONI Quality standards

KONI RAID and Heavy Track are specially developed for the on-road and off-road challenges of Light Trucks, 4x4s, and SUVs. Tested and used under the world's most extreme conditions, these KONI dampers satisfy the highest demands regarding safety, stability and road holding grip. For many years, KONI RAID shocks have been the damper of choice for many Dakar Rally racers and support vehicles in Africa and South America where performance, strength and safety are paramount. KONI RAID shocks served their duty on BBC TV's Top Gear North Pole Special and driving up an Icelandic volcano. African Jungle or Urban Jungle, KONI RAID and Heavy Track are ready for the challenge.



# ADJUSTMENT PROCEDURES

## SERIES 26, 30\*

1. Move the dust cover and the plastic or metal cover on the end of the damper body to expose the adjusting button (Figure 1).
2. Hold the damper body securely in one hand near where the piston rod emerges from the body or use a vise/clamp carefully only at the lower attachment only. With the damper fully extended, press and hold the adjuster button with one finger while turning the piston rod with your other hand (Figure 2).
3. The adjusting device has been provided with a number of clearly distinguishable stops (clicks), each of which marks an adjustment position for 26 series (zero + 2 clicks = 3 positions) and 30 series (zero + 3 clicks = 4 positions) (Figure 3).
4. Prior to making a new adjustment, confirm if the damper is in the zero position or has been adjusted previously by turning the piston rod to the left (counter clockwise) until the zero-stop is felt. **DO NOT USE FORCE** or adjuster damage may occur.
5. To increase rebound, turn the piston rod one or more clicks to the right (clockwise), and release the adjusting button.
6. Be sure the adjusting button fully springs back into position. As long as the button is depressed, do not turn the piston rod further; otherwise correct adjustment will be disturbed. As soon as the button has made its complete return, the piston rod may be turned freely. The damper can now be refitted.

*NOTE: 26 Series range limited to 2 clicks, 30 Series range limited to 3 clicks.*

Figure 1

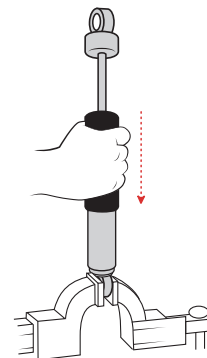

Figure 2

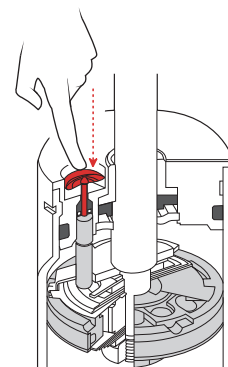
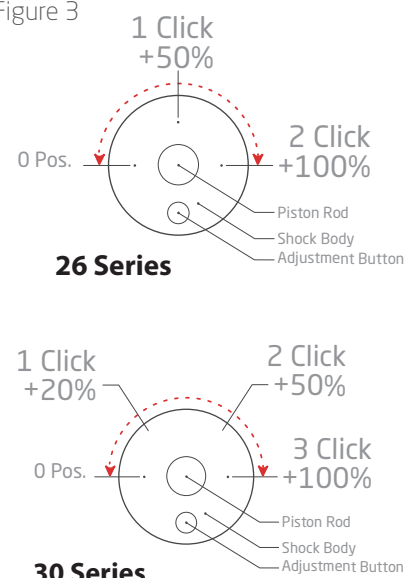

Figure 3



# ADJUSTMENT PROCEDURES

## SERIES 80, 82, 86, 87, 88, 90, 8040, 8240\*

1. Remove the shock absorber from the vehicle and hold it vertically with the lower eye or pin attached in a vise. Use clamp plates to prevent damage.
2. Fully collapse the shock absorber, at the same time turning the dust cap or piston rod slowly to the left (counterclockwise), until it is felt that the cams of the adjustment nut engage in the recesses of the foot valve assembly (Figure 4).

\* Some shock absorbers include a bump rubber concealed under the dust cover and it must be removed prior to adjusting.

4. The damper may have already been adjusted. Therefore check whether the shock absorber is in the adjustment position or not by keeping it collapsed and gently turning it further to the left counting at the same time the half turns until a stop is felt. Stop turning then and do not use force.
5. Keeping the shock absorber collapsed, make 1 half turn (180 degrees) to the right (clockwise). In case of prior adjustment add the number of half the turns previously found. The total range is about 4-5 half turns, we suggest the MAX crank of 4 (Figure 5).
6. Pull the shock absorber out vertically without turning for at least 1 cm to disengage the adjusting mechanism. The dust cap or piston rod may now be turned freely.

## SERIES 3013, 8010, 8041, 8210, 8241, 8610, 8641, 8710, 8741

1. Almost all KONI externally adjustable dampers are quickly and easily adjusted by placing a KONI knob on the adjuster tab that sticks out of the top mounting threading. As shown on the knob, turn counter clockwise for firmer, clockwise for softer (Figure 5).
2. Some externally adjustable shocks use an adjuster window instead of a tab. Insert a pin through the window into a hole, sweeping from left to right for firmer, right to left for softer.

### \*WARNING:

Adjust both left and right dampers identically. Failure to do so may lead to unstable handling and uneven tire tread wear.

To see video of these products, visit: <https://www.youtube.com/user/originalKONI>

Figure 4

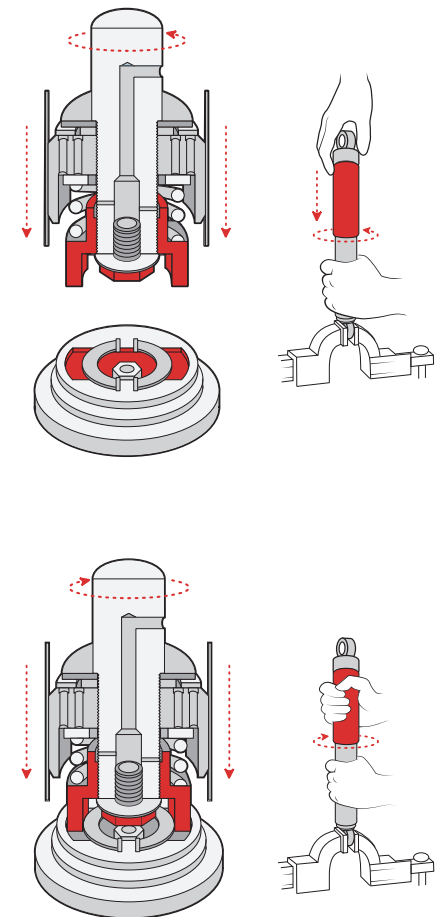
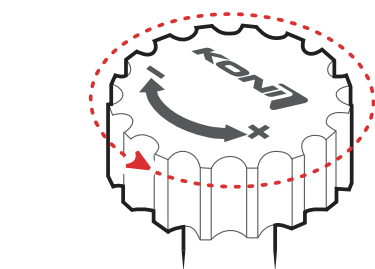

Figure 5



# MISCELLANEOUS INFORMATION

## ORDER NUMBERS EXPLANATION

The given numbers help to find the right shock absorber types. The part number consists of a construction group number referring to the type of construction of the shock, and a reference number referring to the shocks application.

In some cases the reference number contains an "L" or "R" (Left or Right side). Yellow shock absorbers have the extension "SPORT". Specially built shocks have different extensions, for example "SP", or "SPD," or "SPA" and "SPX" (4WD). The numbers on the right refer to a yellow complete McPherson strut, twin-tube with low-pressure gas, sport version, construction Type 8741. In this case for a BMW E36, front axle, left. The rebound damping is externally adjustable.

**Example Order Number:**

8741	1272L	Sport
▼	▼	▼
construction group	reference	sport

		1120 1140 1150	1250	25 026 030	26 30	301	76	80 82 88 90	8010 8210	8040 8240	8041 8241	8042 8242	8045 8245	8050 8250	8205 8805 9905	86
<b>DESIGN</b>	TWIN-TUBE HYDRAULIC	0					0	0	0						0	0
	TWIN-TUBE HYDRAULIC LOW PRESSURE GAS	0								0	0	0	0	0		
	MONO-TUBE HIGH PRESSURE GAS		0	0	0	0										
<b>ADJUSTMENT FEAT.</b>	STANDARD ADJUSTABLE	0			0			0		0						0
	EXTERNALLY ADJUSTABLE	0							0		0					
	DOUBLE EXTERNALLY ADJUSTABLE		0			0						0				
	NOT ADJUSTABLE			0			0						0	0	0	
<b>TECH</b>	ACTIVE (FSD TECHNOLOGY INSIDE)												0		0	
<b>BODY STYLE</b>	STANDARD	0	0	0	0	0	0	0	0	0	0	0	0	0	0	
	(MCPHERSON) STRUT CARTRIDGE															0
	COMPLETE (MCPHERSON) STRUT	0	0													



# MISCELLANEOUS INFORMATION

## ATTACHMENTS KONI HEAVY TRACK & RAID

Due to the build quality and endurance a KONI HEAVY TRACK or KONI RAID shock absorber may outlive its attachment rubbers and bushings.

Replacement parts are available, please contact your KONI reseller or distributor for details.

## SPORT SHORT

When do you need a shock absorber with shortened stroke? If a damper with shortened stroke is needed, please contact your KONI reseller or distributor for possibilities.

## ADJUSTMENT KNOBS

Short version (adjuster pin 2,7 mm x 5 mm) 70 40 03 005 0  
 Short version (adjuster pin 3,2 mm x 7 mm) 70 40 03 007 0  
 High version (adjuster pin 2,7 mm x 5 mm) 70 40 03 003 0  
 High version (adjuster pin 3,2 mm x 7 mm) 70 40 03 004 0  
 Low profile steel (adjuster pin 3,2 mm x 7 mm) 70 40 01 098 0

## SPANNER WRENCH

70 29 17 008 0  
 As used in KONI COIL-OVER KITS

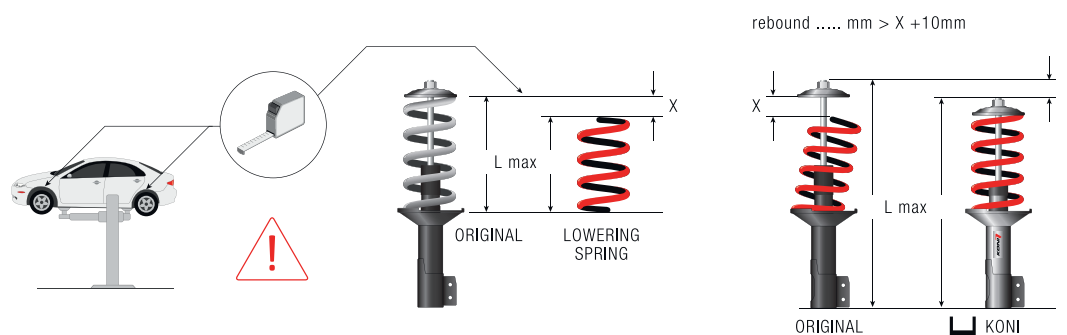

		8610	8640	8641	8645	8650	87	8705	8710	8740	8741	8742	8745	8750
DESIGN	TWIN-TUBE HYDRAULIC	0					0	0	0					
	TWIN-TUBE HYDRAULIC LOW PRESSURE GAS		0	0	0	0				0	0	0	0	0
	MONO-TUBE HIGH PRESSURE GAS													
ADJUSTMENT FEAT.	STANDARD ADJUSTABLE		0				0			0				
	EXTERNALLY ADJUSTABLE	0		0					0		0			
	DOUBLE EXTERNALLY ADJUSTABLE											0		
	NOT ADJUSTABLE				0	0		0					0	0
TECH	ACTIVE (FSD TECHNOLOGY INSIDE)				0			0					0	
BODY STYLE	STANDARD													
	(MCPHERSON) STRUT CARTRIDGE	0	0	0	0	0								
	COMPLETE (MCPHERSON) STRUT						0	0	0	0	0	0	0	0



# INDEX

---

ALPHABETICAL SECTION

**20**

NUMERICAL SECTION

**92**

NEW PART NUMBERS

**112**

NOTES

**117**

GLOSSARY

**119**

MAKE		Year	product range				Lowering up to ..mm		Notes	
Model	Front						Rear			
<b>ABARTH</b>										
<b>500</b>										
500 & 595	07-19	Special-Active	Ⓒ 8745-1247L	Ⓒ 8045-1248						
		STR.T	Ⓒ 8745-1247R	Ⓒ 8050-1146						
	Front axle load up to 770 kg	STR.T Kit	Ⓒ 8750-1127L						I.D.	
		STR.T Kit	Ⓒ 8750-1127R						I.D.	
<b>ACURA</b>										
<b>CL</b>										
Coupé with these KONI Sport dampers the car can be lowered approx. 15 mm	97-99	Sport	N3ⒺⒺⒺⒺⒺⒺ 8041-1185LSport N3ⒺⒺⒺⒺⒺⒺ 8041-1185RSport	R6+R7ⒺⒺⒺⒺⒺⒺ 8041-1168SP4						
	Coupé 3.2 CL with the KONI Sport dampers the car can be lowered approx. 20 mm	01-03	Sport	N3ⒺⒺⒺⒺⒺⒺ 8041-1257Sport	N5ⒺⒺⒺⒺⒺⒺ 8041-1258Sport					
<b>TL</b>										
Sedan 3.2 TL with the KONI Sport dampers the car can be lowered approx. 20 mm	00-03	Sport	N3ⒺⒺⒺⒺⒺⒺ 8041-1257Sport	N5ⒺⒺⒺⒺⒺⒺ 8041-1258Sport						
	Sedan with the KONI Sport dampers the car can be lowered approx. 20 mm	04-06	Sport	N3ⒺⒺⒺⒺⒺⒺ 8041-1322LSport N3ⒺⒺⒺⒺⒺⒺ 8041-1322RSport	M3+N3ⒺⒺⒺⒺⒺⒺ 8041-1329Sport					
<b>Integra</b>										
Sedan / Coupé (DA9) with the KONI Sport dampers the car can be lowered approx. 20 mm	90-93	Sport	P2ⒺⒺⒺⒺⒺⒺ 8041-1200Sport	R1ⒺⒺⒺⒺⒺⒺ 8041-1201Sport					On request	
	Sedan / Coupé (DC2 / DC4) excl. Type R with the KONI Sport dampers the car can be lowered approx. Fr-Rr: 25-15mm	94-01	STR.T	Ⓒ 8050-1011	Ⓒ 8050-1012					
		Sport	N6ⒺⒺⒺⒺⒺⒺ 8041-1152Sport	R4ⒺⒺⒺⒺⒺⒺ 8041-1153Sport						
Type R with the KONI Sport dampers the car can be lowered approx. Fr-Rr: 25-15mm	97-01	STR.T	Ⓒ 8050-1011							
Sport		N6ⒺⒺⒺⒺⒺⒺ 8041-1152Sport	R4ⒺⒺⒺⒺⒺⒺ 8041-1164Sport							
<b>Legend</b>										
Sedan / Coupé (KA7 / KA8) V6-3.2i Front uses OE spring seat. With these dampers the car can be lowered approx. Fr-Rr: 20-15mm	91-97	Special	N4ⒺⒺⒺⒺⒺⒺ 8240-1125	R4ⒺⒺⒺⒺⒺⒺ 8240-1126						
<b>RSX</b>										
RSX Front: for original struts only	02-06	Sport	ⒺⒺⒺⒺ 8610-1415Sport	ⒺⒺⒺⒺ 8010-1050Sport						
<b>TSX</b>										
TSX	04-08	Sport	N3ⒺⒺⒺⒺⒺⒺ 8041-1322LSport N3ⒺⒺⒺⒺⒺⒺ 8041-1322RSport	M3+N3ⒺⒺⒺⒺⒺⒺ 8041-1329Sport						
		Sport	N3ⒺⒺⒺⒺⒺⒺ 8041-1406LSport N3ⒺⒺⒺⒺⒺⒺ 8041-1406RSport	N3ⒺⒺⒺⒺⒺⒺ 8041-1407Sport						
	09-13	Sport								
<b>ALFA ROMEO</b>										
<b>33</b>										
Nuova, incl. 16V & Sport Wagon Front: for Boge original struts only - up to chassisno. 5455777	90-94	Sport	◆ 86-2448Sport							
<b>75</b>										
1.6, 1.8, 2.0, 2.0TD	85-91	Sport		80-2570Sport	80-2571Sport					
1.8 Turbo	86-88	Sport		80-2570Sport	80-2571Sport					
V6	88-91	Sport		80-2570Sport	80-2571Sport					
<b>90</b>										
90	85-87	Sport		80-2570Sport	80-2571Sport					
<b>145 / 146</b>										
1.4, 1.6, 1.7-16V (only boxer engines) Front: for original struts only	06.94-96	STR.T			Ⓒ 8250-1012					
all, TD (only in-line engines) excl. 1.9JTD	95-00	STR.T			Ⓒ 8250-1012					
QV and Ti	95-00	STR.T			Ⓒ 8250-1012					
1.9 JTD	99-00	STR.T			Ⓒ 8250-1012					
<b>147</b>										
1.6TS, 2.0TS, 1.9JTD(M) excl. self-levelling systems	00-05.10	Special-Active	Ⓒ 8045-1021	ⒺⒺⒺⒺ 8745-1020						
		STR.T	Ⓒ 8050-1019	ⒺⒺⒺⒺ 8750-1012						
		Sport	ⒺⒺⒺⒺ 8041-1239Sport	ⒺⒺⒺⒺ 8741-1473Sport						
	Front axle load up to 980 kg	STR.T Kit			1120-3601	35	35	1,2,13		
		Sport Kit			1140-3601	35	35	1,2,13,16		
Front axle load as from 981 kg	STR.T Kit			1120-3602	35	35	1,2,13			
	Sport Kit			1140-3602	35	35	1,2,13,16			
147 GTA	03-05	Sport	ⒺⒺⒺⒺ 8041-1239Sport	ⒺⒺⒺⒺ 8741-1473Sport						
Sport Kit					1140-3603	35	35	1,2,13,16		
<b>156</b>										
Sedan / SportWagon excl. self-levelling systems, Q4, GTA	10.97-06	Special-Active	Ⓒ 8045-1021	ⒺⒺⒺⒺ 8745-1020						
		STR.T	Ⓒ 8050-1019	ⒺⒺⒺⒺ 8750-1012						
		Sport	ⒺⒺⒺⒺ 8041-1239Sport	ⒺⒺⒺⒺ 8741-1473Sport						
	1.6 16V, 1.8 16V, 2.0 16V	STR.T Kit			1120-5051	30	30	1,2,13,15		
		Sport Kit			1140-5051	30	30	1,2,13,15,16		
2.5 V6, 1.9 JTD, 2.4 JTD	STR.T Kit			1120-5052	30	30	1,2,13,15			
	Sport Kit			1140-5052	30	30	1,2,13,15,16			
Sedan / SportWagon 3.2 V6 GTA excl. self-levelling systems	01-06	Sport	ⒺⒺⒺⒺ 8041-1239Sport							

MAKE		Year	product range				Lowering up to ..mm		Notes
Model	Year						Front	Rear	
<b>ALFA ROMEO - CONTINUED</b>									
<b>159</b>									
Sedan, incl. Q4 excl. self-levelling systems	05-12	Sport	ⓂⓄ 8241-1238Sport	ⓃⓄ 8240-1239Sport					
	1750 TBI, 1.8 mpi, 1.9 JTS, 2.2 JTS, 1.9 JTDM, 2.0 JTDM	Sport Kit			1140-1361	35	35	1,2,13,15,17	
	2.4 JTDM	Sport Kit			1140-1364	35	35	1,2,13,15,17	
Sportwagon, incl. Q4 excl. self-levelling systems	05-12	Sport	ⓂⓄ 8241-1238Sport	Ⓞ 8240-1239Sport					
	1750 TBI, 1.8 mpi, 1.9 JTS, 2.2 JTS, 1.9 JTDM, 2.0 JTDM	Sport Kit			1140-1363	35	35	1,2,13,15,17	
	2.4 JTDM	Sport Kit			1140-1362	35	35	1,2,13,15,17	
<b>Alfetta</b>									
Alfetta, excl. GTV	72-86	Sport	80-2241Sport	80-2242Sport					
GTV, GTV6	76-84	Sport	80-2241Sport	80-2242Sport					
GTV, GTV6	85-89	Sport	80-2570Sport	80-2571Sport					
<b>Brera</b>									
Brera Coupé all, incl. Q4	05-11	Sport	ⓂⓄ 8241-1238Sport	ⓃⓄ 8240-1239Sport					
	1750 TBI, 2.2 JTS, 2.0 JTDM	Sport Kit			1140-1361	35	35	1,2,13,15,17	
	3.2 V6, Q4 only	Sport Kit			1140-1362	35	35	1,2,13,15,17	
	2.4 JTDM	Sport Kit			1140-1364	35	35	1,2,13,15,17	
<b>Giulia</b>									
1600 Spider, Sprint, SS	62-09.65	Classic	☞☐ 80-1039	☞ 80-1193					
Giulia, incl. Bertone GTV, Junior	10.65-78	Classic	☞ 80-1551	☞☐ 80-1781					
		Sport	80-1551Sport	☐ 80-1781Sport					
<b>Giulietta</b>									
1300, Berlina 1300	55-64	Classic	☞☐ 80-1039	☞ 80-1193					
Giulietta	78-87	Sport	80-2241Sport	80-2242Sport					
Giulietta Incl. sport suspension	10-19	STR.T	Ⓞ 8750-1124L Ⓞ 8750-1124R	Ⓞ 8250-1052L Ⓞ 8250-1052R				I.D.	
		Sport	ⓂⓄⓈ▲ 8741-1583LSport ⓂⓄⓈ▲ 8741-1583RSport	Ⓞ▲ 8240-1299LSport Ⓞ▲ 8240-1299RSport					
<b>GT</b>									
GT Coupé excl. 3.2 V6	01.04-07.10	Special-Active	Ⓞ 8045-1021	ⓃⓄ 8745-1020					
		STR.T	Ⓞ 8050-1019	ⓃⓄ 8750-1012					
		Sport	ⓂⓄⓄ 8041-1239Sport	ⓃⓂⓄⓄ 8741-1473Sport					
		STR.T Kit			1120-3601	35	35	1,2,13	
		Sport Kit			1140-3601	35	35	1,2,13,16	
Front axle load up to 980 kg		STR.T Kit			1120-3602	35	35	1,2,13	
Front axle load as from 981 kg		Sport Kit			1140-3602	35	35	1,2,13,16	
GT Coupé 3.2 V6	01.04-07.10	Sport	ⓂⓄⓄ 8041-1239Sport	ⓂⓄⓄ 8741-1473Sport					
		Sport Kit			1140-3603	35	35	1,2,13,16	
<b>GTV</b>									
Coupé 1.8-16V	95-05	STR.T		Ⓞ 8050-1068					
		Sport		Ⓞ 30-1608Sport					
Coupé 2.0-16V, up to chassiso 7011933 Front: Adjust dampers one full turn after fitting	95-97	STR.T		Ⓞ 8050-1068					
		Sport		Ⓞ 30-1608Sport					
Coupé 2.0-V6 Turbo	95-03	STR.T		Ⓞ 8050-1068					
		Sport		Ⓞ 30-1608Sport					
Coupé 3.0-V6 24V, 3.2-V6 24V	97-05	STR.T	Ⓞ 8750-1075	Ⓞ 8050-1068					
		Sport	ⓂⓄⓄ 8741-1404Sport	Ⓞ 30-1608Sport					
<b>MiTo</b>									
MiTo 1.4, 1.4T, 1.4TB (incl. QV), 1.3 JTDM, 1.6JTDM	08-18	STR.T	Ⓞ 8750-1093L Ⓞ 8750-1093R	Ⓞ 8050-1113					
		Sport		Ⓞ 8040-1399Sport					
		STR.T Kit			1120-1311	30	30	1,2,13	
Front axle load up to 850Kg		STR.T Kit			1120-1312	30	30	1,2,13	
Front axle load as from 851 kg									
<b>Montreal</b>									
V8	74-76	Sport	80-1551Sport	☐ 80-1781Sport					
<b>Spider</b>									
1300, 1600, 1750, 2000 incl. Duetto, Veloce	67-93	Classic	☞ 80-1551	☞☐ 80-1781					
		Sport	80-1551Sport	☐ 80-1781Sport					
3.0-V6 24V, 3.2-V6 24V	99-05	STR.T	Ⓞ 8750-1075						
Spider 1750 TBI, 2.2 JTS, 3.2 V6 (Q4), 2.0 JTDM, 2.4 JTDM	06-11	Sport	ⓂⓄⓄ 8741-1404Sport	ⓃⓄ 8240-1239Sport					
		Sport Kit	ⓂⓄⓄ 8241-1238Sport		1140-1361	35	35	1,2,13,15,17	
<b>AUDI</b>									
<b>A1</b>									
A1 (8XA, 8XF) excl. DCC (Dynamic Chassis Control)	08.10-18	Special-Active	Ⓞ 8745-1278	Ⓞ 8045-1070					
		STR.T	Ⓞ 8750-1114	Ⓞ 8050-1005					
		Sport	ⓂⓄⓄ 8741-1548Sport	80-2830Sport					
		STR.T Kit			1120-9441	35	35	1,2,13	
		Sport Kit			1140-9441	35	35	1,2,13,17	
Front axle load up to 925 kg		STR.T Kit			1120-9442	35	35	1,2,13	
Front axle load as from 926 kg		Sport Kit			1140-9442	35	35	1,2,13,17	

MAKE	Model	Year	product range				Lowering up to ..mm		Notes
							Front	Rear	
<b>AUDI - CONTINUED</b>									
<b>A2</b>									
A2 (8Z0) excl. 1.2 TDi 3L	00-05	Special-Active	Ⓒ 8745-1069	Ⓒ 8045-1070					
		STR.T	Ⓒ 8750-1004	Ⓒ 8050-1005					
		Sport	Ⓜ 8710-1404Sport	80-2830Sport					
		1.4, 1.6	STR.T Kit			1120-3881	25	25	1,2,13
		Sport Kit				1140-3881	25	25	1,2,13,17
		1.4 TDI	STR.T Kit			1120-3882	25	25	1,2,13
		Sport Kit			1140-3882	25	25	1,2,13,17	
<b>A3</b>									
A3 (8L), excl. Quattro, HD suspension if equipped with Audi-Sport Suspension: KONI Special is excluded	09.96-03	Special	▲ 87-2571	▲ 80-2761					
		Special-Active	Ⓒ 8745-1029	Ⓒ 8045-1083					
		STR.T	Ⓒ 8750-1002	Ⓒ 8050-1001					
		Sport	Ⓜ 8710-1337Sport	80-2761Sport					
		Front axle load up to 910 kg	STR.T Kit			1120-7671	35	35	1,2,13
		Sport Kit				1140-7671	35	35	1,2,13,17
	Front axle load as from 911 kg	STR.T Kit			1120-7672	35	35	1,2,13	
			Sport Kit			1140-7672	35	35	1,2,13,17
	A3 (8L) Quattro up to chassiso. 8L- -140000	98-99	Special-Active	Ⓒ 8745-1029	Ⓒ 8245-1032				
			STR.T	Ⓒ 8750-1002	Ⓒ 8050-1086				
			Sport	Ⓜ 8710-1337Sport	80-2806Sport				
	A3 (8L) Quattro as from chassiso. 8L- -140001	99-03	Special-Active	Ⓒ 8745-1030	Ⓒ 8245-1032				
STR.T			Ⓒ 8750-1063	Ⓒ 8050-1086					
Sport			Ⓜ 8710-1385Sport	80-2806Sport					
STR.T Kit					1120-4382	25	25	1,2,13	
		Sport Kit			1140-4382	25	25	1,2,13,17	
A3 (8P), incl. Sportback, excl. Quattro Front: for original struts 55 mm only	05.03-12	Special-Active	Ⓒ 8745-1006	Ⓒ 8045-1084					
		STR.T	Ⓒ 8750-1005	Ⓒ 8050-1006					
		Sport	Ⓜ 8710-1431Sport	80-2859Sport					
		Front axle load up to 1020 kg	STR.T Kit			1120-2611	35	35	1,2,13
		Sport Kit				1140-2611	35	35	1,2,13,17
		Coil-over Kit				1150-5080-1	60	50	9,17,21,23 NO T V
	Front axle load as from 1021 kg	STR.T Kit			1120-2612	35	35	1,2,13	
		Sport Kit			1140-2612	35	35	1,2,13,17	
	Coil-over Kit				1150-5080-1	60	50	9,17,21,23 NO T V	
	Front: for original struts 50 mm only	Special-Active		Ⓒ 8045-1084					
		STR.T	Ⓒ 8750-1006	Ⓒ 8050-1006					
	Sport	Ⓜ 8710-1432Sport	80-2859Sport						
Front axle load up to 1020 kg	STR.T Kit			1120-2613	35	35	1,2,13		
Sport Kit				1140-2613	35	35	1,2,13,17		
Front axle load as from 1021 kg	STR.T Kit			1120-2614	35	35	1,2,13		
	Sport Kit			1140-2614	35	35	1,2,13,17		
A3 (8P) Quattro excl. S-line suspension 3.2 V6	05.03-12	Special-Active	Ⓒ 8745-1006	Ⓒ 8045-1084					
		STR.T	Ⓒ 8750-1005	Ⓒ 8050-1006					
		Sport	Ⓜ 8710-1431Sport	80-2859Sport					
		STR.T Kit			1120-2271	35	35	1,2,13	
		Sport Kit			1140-2271	35	35	1,2,13,17	
A3 (8P) with S-line Suspension, incl. Quattro, 3.2	05.03-12	Special-Active	Ⓒ 8745-1225	Ⓒ 8045-1226					
		Sport	Ⓜ 8710-1431Sport	80-2859Sport					
A3 (8P) Cabrio, all engines Front: for original struts 55 mm only	01.08-12	Special-Active	Ⓒ 8745-1225	Ⓒ 8045-1226					
		Sport	Ⓜ 8710-1431Sport	Ⓒ 8040-1371Sport					
A3 (8V) excl. E-Tron, Cabrio, S3, RS3, S-Line Susp Front: for original struts 50 mm only Rear: only for cars with torsion-beam rear suspension	12-18	Special-Active	Ⓒ 8745-1324	Ⓒ 8245-1326					
		STR.T	Ⓒ 8750-1115	Ⓒ 8250-1044					
		Sport	Ⓜ 8741-1571Sport	Ⓒ 8240-1296Sport					
		STR.T Kit			I.D.				
		Sport Kit			I.D.				
		Front: for original struts 50 mm only Rear: only for cars with multi-link suspension	Special-Active	Ⓒ 8745-1324	Ⓒ 8245-1327				
		STR.T	Ⓒ 8750-1115	Ⓒ 8250-1050					
	Sport	Ⓜ 8741-1571Sport	Ⓒ 8240-1297Sport						
	Front: for original struts 55 mm only Rear: only for cars with torsion-beam rear suspension	Special-Active	Ⓒ 8745-1325	Ⓒ 8245-1326					
		STR.T	Ⓒ 8750-1123	Ⓒ 8250-1044					
	Sport	Ⓜ 8741-1572Sport	Ⓒ 8240-1296Sport						
	Front: for original struts 55 mm only Rear: only for cars with multi-link suspension.	Special-Active	Ⓒ 8745-1325	Ⓒ 8245-1327					
	STR.T	Ⓒ 8750-1123	Ⓒ 8250-1050						
Sport	Ⓜ 8741-1572Sport	Ⓒ 8240-1297Sport							
A3 (8V) Quattro incl. Audi-Sport Suspension Front: for original struts 55 mm only Rear: only for cars with multi-link suspension. Excl. A DI Magnetic Ride	12-18	Special-Active	Ⓒ 8745-1325	Ⓒ 8245-1327					
		STR.T	Ⓒ 8750-1123	Ⓒ 8250-1050					
		Sport	Ⓜ 8741-1572Sport	Ⓒ 8240-1297Sport					
A3 (8V) Cabrio, incl. Audi Sport Suspension(-15mm) Front: for original struts 50 mm only Rear: only for cars with multi-link suspension	01.14-18	Special-Active	Ⓒ 8745-1324						
		STR.T	Ⓒ 8750-1115	Ⓒ 8250-1050					
		Sport	Ⓜ 8741-1571Sport	Ⓒ 8240-1306Sport					
		Front axle load up to 1010 kg	Sport Kit			1140-8605	25	25	1,2, 13, 17
Front axle load as from 1011 kg	Sport Kit			1140-8606	25	25	1, 2, 13, 17		
A3 (8V) Cabrio Quattro incl. Audi Sport suspension Front: for original struts 55 mm only Rear: only for cars with multi-link suspension. Excl. A DI Magnetic Ride	01.14-18	Special-Active	Ⓒ 8745-1388						
		STR.T	Ⓒ 8750-1123	Ⓒ 8250-1050					
		Sport	Ⓜ 8741-1572Sport	Ⓒ 8240-1306Sport					
		Sport Kit			I.D.			1, 2, 13, 17	

MAKE		Year	product range				Lowering up to ..mm		Notes		
Model	Front						Rear				
<b>AUDI - CONTINUED</b>											
A3 (8V) E-Tron 1.4 TFSI Plug-in Hybrid	14-19	Special-Active	Ⓒ 8745-1325	Ⓒ 8245-1327							
		Sport	Ⓒ 8741-1572Sport	Ⓒ 8240-1297Sport							
A3 (8V) G-Tron 1.4 TFSI CNG	14-18	Special-Active	Ⓒ 8745-1325	Ⓒ 8245-1327							
		Sport	Ⓒ 8741-1572Sport	Ⓒ 8240-1297Sport							
<b>A4</b>											
A4 (B5) Sedan up to chassisnr. 8-D- -199999, excl. Quattro and Audi Sport Suspension	11.94-98	STR.T	Ⓒ 8250-1001								
A4 (B5) Avant up to chassisnr. 8-D- -199999, excl. Quattro and Audi Sport Suspension	11.94-98	STR.T	Ⓒ 8250-1001								
A4 (B5) Sedan/Avant with Audi Sport Suspension up to chassisnr. 8-D- -199999, excl. Quattro and D Suspension	11.94-98	STR.T	Ⓒ 8250-1001								
A4 (B5) Sedan as from chassisnr. 8-D- -200000, excl. Quattro and Audi Sport Suspension	98-10.01	STR.T	Ⓒ 8250-1001								
A4 (B5) Avant as from chassisnr. 8-D- -200000, excl. Quattro and Audi Sport Suspension	98-10.01	STR.T	Ⓒ 8250-1001								
A4 (B5) Sedan/Avant with Audi Sport Suspension as from chassisnr. 8-D- -200000, excl. Quattro and D Suspension	98-10.01	STR.T	Ⓒ 8250-1001								
A4 (B6/B7, 8E) Sedan Incl. sport suspension, excl. Quattro S-Line Suspension	11.00-07	Special-Active	Ⓒ 8245-1008	Ⓒ 8045-1246							
		STR.T	Ⓒ 8250-1011	Ⓒ 8050-1055							
		Sport	Ⓒ 8240-1185Sport	Ⓒ 8040-1283Sport							
		STR.T Kit			1120-3691	35	35	1,2,13			
Front axle load up to 1050 kg		Sport Kit			1140-3691	35	35	1,2,13			
Front axle load as from 1051 kg		STR.T Kit			1120-3692	35	35	1,2,13			
		Sport Kit			1140-3692	35	35	1,2,13			
A4 (B6/B7, 8E) Avant Incl. sport suspension, excl. Quattro S-Line Suspension	04.01-07	Special-Active	Ⓒ 8245-1008	Ⓒ 8045-1246							
		STR.T	Ⓒ 8250-1011	Ⓒ 8050-1055							
		Sport	Ⓒ 8240-1185Sport	Ⓒ 8040-1283Sport							
		STR.T Kit			1120-3691	35	35	1,2,13			
Front axle load up to 1050 kg		Sport Kit			1140-3691	35	35	1,2,13			
Front axle load as from 1051 kg		STR.T Kit			1120-3692	35	35	1,2,13			
		Sport Kit			1140-3692	35	35	1,2,13			
A4 (B6/B7, 8E) Sedan/Avant Quattro Incl. sport suspension	11.00-07	Special-Active	Ⓒ 8245-1008	Ⓒ 8045-1246							
		STR.T	Ⓒ 8250-1011	Ⓒ 8050-1055							
		Sport	Ⓒ 8240-1185Sport	Ⓒ 8040-1283Sport							
		STR.T Kit			1120-3681	45	45	1,2,13			
Front axle load up to 1140 kg		Sport Kit			1140-3681	45	45	1,2,13			
Front axle load as from 1141 kg		STR.T Kit			1120-3682	45	45	1,2,13			
		Sport Kit			1140-3682	45	45	1,2,13			
A4 all (B6/B7, 8E,8H) with S-line Suspension Incl. Cabrio	11.00-07	STR.T	Ⓒ 8250-1011	Ⓒ 8050-1055							
		Sport	Ⓒ 8240-1185Sport	Ⓒ 8040-1283Sport							
		STR.T Kit									
		Sport Kit									
A4 (B8, 8K) Sedan 1.8/2.0/3.2, 2.0/2.7/3.0TDI Excl. Audi S-Line Suspension	03.08-15	Special-Active	Ⓒ 8245-1221	Ⓒ 8045-1222							
		STR.T	Ⓒ 8250-1047	Ⓒ 8050-1141							
		Sport	Ⓒ 8240-1261Sport	Ⓒ 8040-1390Sport							
		STR.T Kit			1120-0613	30	45	1,2,13			
		2WD, front axle load up to 1100 kg		Sport Kit			1140-0613	30	45	1,2,13	
		2WD, front axle load as from 1101 kg		STR.T Kit			1120-0611	30	45	1,2,13	
				Sport Kit			1140-0611	30	45	1,2,13	
		Quattro, front axle load up to 1100 kg		STR.T Kit			1120-0614	30	30	1,2,13	
				Sport Kit			1140-0614	30	30	1,2,13	
		Quattro, front axle load as from 1101 kg		STR.T Kit			1120-0612	30	30	1,2,13	
				Sport Kit			1140-0612	30	30	1,2,13	
		A4 (B8, 8K) Avant 1.8/2.0/3.2, 2.0/2.7/3.0TDI Excl. Audi S-Line Suspension, excl. Allroad	03.08-15	Special-Active	Ⓒ 8245-1221	Ⓒ 8045-1222					
STR.T	Ⓒ 8250-1047			Ⓒ 8050-1141							
Sport	Ⓒ 8240-1261Sport			Ⓒ 8040-1390Sport							
STR.T Kit					1120-0614	30	30	1,2,13			
2WD Quattro, front axle load up to 1100 kg				Sport Kit			1140-0614	30	30	1,2,13	
2WD Quattro, front axle load as from 1101 kg				STR.T Kit			1120-0612	30	30	1,2,13	
				Sport Kit			1140-0612	30	30	1,2,13	
Incl. Audi S-Line Suspension, excl. Allroad				Special-Active	Ⓒ 8245-1264	Ⓒ 8045-1265					
				STR.T	Ⓒ 8250-1048	Ⓒ 8050-1142				I.D.	
				Sport	Ⓒ 8240-1279Sport	Ⓒ 8040-1402Sport					
A4L (B8, 8K) - China market Excl. Audi S-Line Suspension, excl. Allroad	07-15			Special-Active	Ⓒ 8245-1221	Ⓒ 8045-1222					
				STR.T	Ⓒ 8250-1047	Ⓒ 8050-1141					
		Sport	Ⓒ 8240-1261Sport	Ⓒ 8040-1390Sport							
		Special-Active	Ⓒ 8245-1264	Ⓒ 8045-1265							
Incl. Audi S-Line Suspension, excl. Allroad		STR.T	Ⓒ 8250-1048	Ⓒ 8050-1142							
		Sport	Ⓒ 8240-1279Sport	Ⓒ 8040-1402Sport							
A4 (B9, 8W) Excl. Audi S-Line Suspension, excl. Allroad	05.15-	Special-Active	I.D.	Ⓒ I.D.					I.D.		
		Sport	I.D.	Ⓒ I.D.					I.D.		
		Sport Kit							I.D.		

MAKE		Year	product range				Lowering up to ..mm		Notes
Model							Front	Rear	
<b>AUDI - CONTINUED</b>									
<b>A5</b>									
<b>A5 (8T) Coupé 1.8T, 2.0T, 3.2, all TDI</b> Excl. Audi S-Line Suspension	07-15	Special-Active	Ⓒ 8245-1221	Ⓝ Ⓒ 8045-1222					
		STR.T	Ⓒ 8250-1047	Ⓝ Ⓒ 8050-1141					
		Sport	Ⓒ 8240-1261Sport	Ⓝ Ⓒ 8040-1390Sport					
2WD Quattro, front axle load up to 1100 kg		STR.T Kit			1120-0613	25	25	1,2,13	
		Sport Kit			1140-0613	25	25	1,2,13	
		STR.T Kit			1120-0611	25	25	1,2,13	
2WD Quattro, front axle load as from 1101 kg		Sport Kit			1140-0611	25	25	1,2,13	
		Special-Active	Ⓒ 8245-1264	Ⓒ 8045-1265					
		STR.T	Ⓒ 8250-1048	Ⓒ 8050-1142					
With Audi S-Line Suspension		Sport	Ⓒ 8240-1279Sport	Ⓒ 8040-1402Sport					
		Special-Active	Ⓒ 8245-1221	Ⓝ Ⓒ 8045-1222					
		STR.T	Ⓒ 8250-1047	Ⓝ Ⓒ 8050-1141					
2WD Quattro, front axle load up to 1100 kg		Sport	Ⓒ 8240-1261Sport	Ⓝ Ⓒ 8040-1390Sport					
		STR.T Kit			1120-0614	25	25	1,2,13	
		Sport Kit			1140-0614	25	25	1,2,13	
2WD Quattro, front axle load as from 1101 kg		STR.T Kit			1120-0612	25	25	1,2,13	
		Sport Kit			1140-0612	25	25	1,2,13	
		Special-Active	Ⓒ 8245-1264	Ⓝ Ⓒ 8045-1265					
With Audi S-Line Suspension		STR.T	Ⓒ 8250-1048	Ⓝ Ⓒ 8050-1142					
		Sport	Ⓒ 8240-1279Sport	Ⓝ Ⓒ 8040-1402Sport					
		STR.T Kit			1120-0614	25	25	1,2,13	
2WD Quattro, front axle load up to 1100 kg		Sport Kit			1140-0614	25	25	1,2,13	
		STR.T Kit			1120-0612	25	25	1,2,13	
		Sport Kit			1140-0612	25	25	1,2,13	
2WD Quattro, front axle load as from 1101 kg		STR.T Kit			1120-0612	25	25	1,2,13	
		Sport Kit			1140-0612	25	25	1,2,13	
		Special-Active	Ⓒ 8245-1221	Ⓒ 8045-1265					
<b>A5 (8F) Cabriolet 1.8T, 2.0T, 3.2, all TDI</b> Excl. Audi S-Line Suspension	03.09-15	STR.T	Ⓒ 8250-1047	Ⓒ 8050-1141					
		Sport	Ⓒ 8240-1261Sport	Ⓒ 8040-1402Sport					
		STR.T Kit			1120-0614	30	30	1,2,13	
2WD Quattro, front axle load up to 1100 kg		Sport Kit			1140-0614	30	30	1,2,13	
		STR.T Kit			1120-0612	30	30	1,2,13	
		Sport Kit			1140-0612	30	30	1,2,13	
With Audi S-Line Suspension		STR.T	Ⓒ 8250-1048	Ⓒ 8050-1142					
		Sport	Ⓒ 8240-1279Sport	Ⓒ 8040-1402Sport					
		Sport							I.D.
<b>A6</b>									
<b>A6 (C4) Sedan / Avant</b>	94-05-97	Special	▲ 86-2149						
		STR.T	Ⓒ 8650-1007						
		Sport	86-2149Sport	Ⓝ 80-2762Sport					
<b>A6 (C4Q) Sedan / Avant Quattro</b> Rear: M10 top nut	94-05-97	Sport	86-2149Sport	Ⓝ 80-2762Sport					
		Rear: M12 top nut	Sport	86-2149Sport	Ⓝ 80-2630Sport				
		STR.T	Ⓒ 8250-1001	Ⓝ Ⓒ 8050-1009					
<b>A6 (C5, 4B) Sedan, excl. Air-susp.</b> front axle load up to 1115kg, excl. Quattro - if equip. with Audi Sport Susp: except KONI Special	97-00	Sport	82-2488Sport	Ⓝ Ⓒ 8040-1227Sport					
		STR.T Kit			1120-7932	40	40	1,2,13,15	
		Sport Kit			1140-7932	40	40	1,2,13,15	
<b>A6 (C5, 4B) Sedan, excl. Air-susp.</b> front axle load up to 1115kg, excl. Quattro - if equip. with Audi Sport Susp: except KONI Special	00-04	STR.T	Ⓒ 8250-1001	Ⓝ Ⓒ 8050-1009					
		Sport	82-2488Sport	Ⓝ Ⓒ 8040-1227Sport					
		STR.T Kit			1120-7932	40	40	1,2,13,15	
<b>A6 (C5, 4B) Sedan, excl. Air-susp.</b> front axle load as from 1116 kg, excl. Quattro - if equip. with Audi Sport Susp: except KONI Special	97-00	Sport Kit			1140-7932	40	40	1,2,13,15	
		STR.T	Ⓒ 8250-1001	Ⓝ Ⓒ 8050-1009					
		Sport	82-2488Sport	Ⓝ Ⓒ 8040-1227Sport					
<b>A6 (C5, 4B) Sedan, excl. Air-susp.</b> front axle load as from 1116 kg, excl. Quattro - if equip. with Audi Sport Susp: except KONI Special	00-04	STR.T Kit			1120-7931	40	40	1,2,13,15	
		Sport Kit			1140-7931	40	40	1,2,13,15	
		STR.T	Ⓒ 8250-1001	Ⓝ Ⓒ 8050-1009					
<b>A6 (C5, 4B) Avant, excl. Air-susp.</b> front axle load up to 1115kg, excl. Quattro - if equip. with Audi Sport Susp: except KONI Special	03.98-00	Sport	82-2488Sport	Ⓝ Ⓒ 8040-1227Sport					
		STR.T Kit			1120-7961	40	40	1,2,13,15	
		Sport Kit			1140-7961	40	40	1,2,13,15	
<b>A6 (C5, 4B) Avant, excl. Air-susp.</b> front axle load up to 1115kg, excl. Quattro - if equip. with Audi Sport Susp: except KONI Special	00-04	STR.T	Ⓒ 8250-1001	Ⓝ Ⓒ 8050-1009					
		Sport	82-2488Sport	Ⓝ Ⓒ 8040-1227Sport					
		Sport Kit			1140-7961	40	40	1,2,13,15	
<b>A6 (C5, 4B) Avant, excl. Air-susp.</b> front axle load as from 1116 kg, excl. Quattro - if equip. with Audi Sport Susp: except KONI Special	03.98-00	STR.T	Ⓒ 8250-1001	Ⓝ Ⓒ 8050-1009					
		Sport	82-2488Sport	Ⓝ Ⓒ 8040-1227Sport					
		STR.T Kit			1120-7962	40	40	1,2,13,15	
<b>A6 (C5, 4B) Avant, excl. Air-susp.</b> front axle load as from 1116 kg, excl. Quattro - if equip. with Audi Sport Susp: except KONI Special	00-04	Sport Kit			1140-7962	40	40	1,2,13,15	
		STR.T	Ⓒ 8250-1001	Ⓝ Ⓒ 8050-1009					
		Sport	82-2488Sport	Ⓝ Ⓒ 8040-1227Sport					
<b>A6 (C5, 4B) Sedan / Avant Quattro incl. V8</b> excl. Audi Sport Suspension, Air suspension	97-00	Sport Kit			1140-7962	40	40	1,2,13,15	
		STR.T	Ⓒ 8250-1001	Ⓝ Ⓒ 8250-1004					
		Sport	82-2488Sport	Ⓝ 82-2465Sport					
Sedan, front axle load up to 1115 kg		STR.T Kit			1120-7971	40	40	1,2,13,15	
		Sport Kit			1140-7971	40	40	1,2,13,15	
		Sport Kit							



MAKE		product range				Lowering up to ..mm		Notes
Model	Year					Front	Rear	
<b>AUDI - CONTINUED</b>								
Sedan, front axle load as from 1116kg		STR.T Kit			1120-7972	40	40	1,2,13,15
		Sport Kit			1140-7972	40	40	1,2,13,15
Avant, front axle load up to 1115 kg		STR.T Kit			1120-7981	40	40	1,2,13,15
		Sport Kit			1140-7981	40	40	1,2,13,15
Avant, front axle load as from 1116kg		STR.T Kit			1120-7982	40	40	1,2,13,15
		Sport Kit			1140-7982	40	40	1,2,13,15
incl. Audi Sport Suspension, excl. Air suspension		Sport	82-2516Sport	Ⓝ 82-2526Sport				
Sedan, front axle load up to 1115 kg		Sport Kit			1140-7973	40	40	1,2,13,15
Sedan, front axle load as from 1116kg		Sport Kit			1140-7974	40	40	1,2,13,15
Avant, front axle load up to 1115 kg		Sport Kit			1140-7983	40	40	1,2,13,15
Avant, front axle load as from 1116kg		Sport Kit			1140-7984	40	40	1,2,13,15
<b>A6 (C5, 4B) Sedan / Avant Quattro incl. V8</b> excl. Audi Sport Suspension, Air suspension	00-04	STR.T	Ⓞ 8250-1001	ⓃⓄ 8250-1004				
		Sport	82-2488Sport	Ⓝ 82-2465Sport				
Sedan, front axle load up to 1115 kg		STR.T Kit			1120-7971	40	40	1,2,13,15
		Sport Kit			1140-7971	40	40	1,2,13,15
Sedan, front axle load as from 1116kg		STR.T Kit			1120-7972	40	40	1,2,13,15
		Sport Kit			1140-7972	40	40	1,2,13,15
Avant, front axle load up to 1115 kg		STR.T Kit			1120-7981	40	40	1,2,13,15
		Sport Kit			1140-7981	40	40	1,2,13,15
Avant, front axle load as from 1116kg		STR.T Kit			1120-7982	40	40	1,2,13,15
		Sport Kit			1140-7982	40	40	1,2,13,15
incl. Audi Sport Suspension, excl. Air suspension		Sport	82-2516Sport	Ⓝ 82-2526Sport				
Sedan, front axle load up to 1115 kg		Sport Kit			1140-7973	40	40	1,2,13,15
Sedan, front axle load as from 1116kg		Sport Kit			1140-7974	40	40	1,2,13,15
Avant, front axle load up to 1115 kg		Sport Kit			1140-7983	40	40	1,2,13,15
Avant, front axle load as from 1116kg		Sport Kit			1140-7984	40	40	1,2,13,15
<b>A6 (C6, 4F) Sedan, incl. Quattro, excl. Air-susp.</b> Front axle load up to 1215 kg	06.04-11	STR.T	Ⓞ 8250-1022	ⓃⓄ 8250-1023				
		Sport	Ⓞ 8240-1229Sport	ⓃⓄ 8240-1230Sport				
		STR.T Kit			1120-2001	40	40	1,2,13
		Sport Kit			1140-2001	40	40	1,2,13
Front axle load as from 1216 kg		STR.T	Ⓞ 8250-1022	ⓃⓄ 8250-1023				
		Sport	Ⓞ 8240-1229Sport	ⓃⓄ 8240-1230Sport				
		STR.T Kit			1120-2002	40	40	1,2,13
		Sport Kit			1140-2002	40	40	1,2,13
<b>A6 (C6, 4F) Avant, incl. Quattro, excl. Air-susp.</b> Front axle load up to 1215 kg	01.05-11	STR.T	Ⓞ 8250-1022	ⓃⓄ 8250-1023				
		Sport	Ⓞ 8240-1229Sport	ⓃⓄ 8240-1230Sport				
		STR.T Kit			1120-2003	40	40	1,2,13
		Sport Kit			1140-2003	40	40	1,2,13
Front axle load as from 1216 kg		STR.T	Ⓞ 8250-1022	ⓃⓄ 8250-1023				
		Sport	Ⓞ 8240-1229Sport	ⓃⓄ 8240-1230Sport				
		STR.T Kit			1120-2004	40	40	1,2,13
		Sport Kit			1140-2004	40	40	1,2,13
<b>A6L (C6, 4F) - China market</b> incl. Quattro, excl. air suspension	04-11	STR.T	Ⓞ 8250-1022	Ⓞ 8250-1023				
		Sport	Ⓞ 8240-1229Sport	Ⓞ 8240-1230Sport				
<b>A6 (C7, 4G) Sedan</b> Excl. Audi S-Line Suspension air suspension	11-18	Special-Active	Ⓞ 8245-1294	ⓃⓄ 8045-1222				
		STR.T	Ⓞ 8250-1047	ⓃⓄ 8050-1141				
		Sport	Ⓞ 8240-1261Sport	ⓃⓄ 8040-1390Sport				
2WD, front axle load up to 1185 kg		STR.T Kit			1120-9171	35	35	1,2,13
		Sport Kit			1140-9171	35	35	1,2,13
2WD, front axle load as from 1186 kg		STR.T Kit			1120-9172	35	35	1,2,13
		Sport Kit			1140-9172	35	35	1,2,13
Quattro, front axle load up to 1185 kg		STR.T Kit			1120-9173	35	35	1,2,13
		Sport Kit			1140-9173	35	35	1,2,13
Quattro, front axle load as from 1186 kg		STR.T Kit			1120-9174	35	35	1,2,13
		Sport Kit			1140-9174	35	35	1,2,13
With Audi S-Line Suspension, excl. air suspension		Special-Active	Ⓞ 8245-1264	ⓃⓄ 8045-1265				
		STR.T	Ⓞ 8250-1048	ⓃⓄ 8050-1142				
		Sport	Ⓞ 8240-1279Sport	ⓃⓄ 8040-1402Sport				
<b>A6 (C7, 4G) Avant</b> Excl. Audi S-Line Suspension air suspension Allroad	11-18	Special-Active	Ⓞ 8245-1294	ⓃⓄ 8045-1222				
		STR.T	Ⓞ 8250-1047	ⓃⓄ 8050-1141				
		Sport	Ⓞ 8240-1261Sport	ⓃⓄ 8040-1390Sport				
2WD Quattro, front axle load up to 1185 kg		STR.T Kit			1120-9175	35-40	35-40	1,2,13,15
		Sport Kit			1140-9175	35-40	35-40	1,2,13,15
2WD Quattro, front axle load as from 1186 kg		STR.T Kit			1120-9176	35-40	35-40	1,2,13,15
		Sport Kit			1140-9176	35-40	35-40	1,2,13,15
With Audi S-Line Suspension, excl. air suspension Allroad		Special-Active	Ⓞ 8245-1264	ⓃⓄ 8045-1265				
		STR.T	Ⓞ 8250-1048	ⓃⓄ 8050-1142				
		Sport	Ⓞ 8240-1279Sport	ⓃⓄ 8040-1402Sport				
2WD Quattro, front axle load up to 1185 kg		STR.T Kit			1120-9175	35	35	1,2,13
		Sport Kit			1140-9175	35	35	1,2,13
2WD Quattro, front axle load as from 1186 kg		STR.T Kit			1120-9176	35	35	1,2,13
		Sport Kit			1140-9176	35	35	1,2,13

MAKE	Model	Year	product range				Lowering up to ..mm		Notes
							Front	Rear	
<b>AUDI - CONTINUED</b>									
<b>A7</b>									
	<b>A7 (4G) 2WD &amp; Quattro - excl S7/RS7</b> Excl. Audi S-Line Suspension air suspension	10-18	Special-Active	© 8245-1294	Ⓝ 8045-1222				
			STR.T	© 8250-1047	Ⓝ 8050-1141				
			Sport	© 8240-1261Sport	Ⓝ 8040-1390Sport				
	2WD, front axle load up to 1185 kg		STR.T Kit			1120-9171	20	20	1,2,13
			Sport Kit			1140-9171	20	20	1,2,13
	2WD, front axle load as from 1186 kg		STR.T Kit			1120-9172	20	20	1,2,13
			Sport Kit			1140-9172	20	20	1,2,13
	Quattro, front axle load up to 1185 kg		STR.T Kit			1120-9173	20	20	1,2,13
			Sport Kit			1140-9173	20	20	1,2,13
	Quattro, front axle load as from 1186 kg		STR.T Kit			1120-9174	20	20	1,2,13
			Sport Kit			1140-9174	20	20	1,2,13
	With Audi S-Line Suspension, excl. air suspension		Special-Active	© 8245-1264	Ⓝ 8045-1265				
			STR.T	© 8250-1048	Ⓝ 8050-1142				
			Sport	© 8240-1279Sport	Ⓝ 8040-1402Sport				
<b>Q2</b>									
	<b>Q2 (GAB) 1.0TFSI, 1.4TSI, 2.0TFSI, 1.6TDI, 2.0TDI</b>	06.16-	Special-Active	I.D.	I.D.				
<b>Q3</b>									
	<b>Q3 (8U)</b> excl. models with electronic suspension system	11-18	Special-Active	© 8745-1263	© 8045-1228				
			Sport	Ⓜ 8741-1488Sport	© 8040-1395Sport				
<b>Q5</b>									
	<b>Q5 (8R)</b> Excl. Audi S-Line Suspension	09.08-16	Special-Active	© 8245-1264					
			Sport	© 8240-1279Sport	Ⓝ 8040-1403Sport				
	2.0 TFSI, 3.2 TFSI, 2.0 TDI		Sport Kit			1140-0011	40	40	1,2,13,15
	3.0 TDI		Sport Kit			1140-0012	40	40	1,2,13,15
<b>S2</b>									
	<b>S2 (B3, 8B) Coupé Quattro 2.3E-20V Turbo</b>	90-95	Sport	86-2086SPD2	86-2433Sport				
	<b>S2 Avant</b>	93-95	Sport	86-2086SPD2	Ⓜ 8210-1160Sport				
			Sport Kit			1140-9091	30	30	1,2,13,18
<b>RS2</b>									
	<b>RS2 Avant</b>	94-96	Sport	86-2086SPD2	Ⓜ 8210-1160Sport				
			Sport Kit			1140-9691	30	30	1,2,13,18
<b>S3</b>									
	<b>S3 (8L) Quattro</b>	99-06.03	Special-Active	© 8745-1030	© 8245-1032				
			STR.T	© 8750-1062	© 8050-1086				
			Sport	Ⓜ 8710-1377Sport	80-2806Sport				
			STR.T Kit			1120-4384	25	25	1,2,13
			Sport Kit			1140-4383	25	25	1,2,13,17
	<b>S3 (8P) Quattro incl. Sportback, excl. Magn. Ride</b>	06-12	Sport	Ⓜ 8741-1515Sport	© 8040-1371Sport				
			Sport Kit			1140-1001	25	20	1,2,13,17
<b>S4</b>									
	<b>S4 Sedan / Avant Quattro</b>	91-05.94	Sport	86-2149Sport	Ⓝ 80-2630Sport				
	<b>S4 (B5) Sedan Quattro</b> Rear: damper unit must be removed from car before it can be adjusted	97-02	Sport	82-2516Sport	Ⓝ 8210-1165Sport				
			Sport Kit			1140-4771	40	40	1,2,13,15,18
	<b>S4 (B5) Avant Quattro</b> Rear: damper unit must be removed from car before it can be adjusted	97-02	Sport	82-2516Sport	Ⓝ 8210-1165Sport				
			Sport Kit			1140-4772	40	40	1,2,13,15,18
	<b>S4 (B6/B7, 8E) Sedan, Avant 4.2 V8 Quattro</b>	03-07	Sport	© 8240-1235Sport	Ⓝ 8040-1283Sport				
			Sport Kit			1140-2571	30	30	1,2,13
	<b>S4 (B8, 8K) Sedan, Avant 3.0 TFSI Quattro</b>	10.08-13	Special-Active	© 8245-1264	© 8045-1265				
			Sport	© 8240-1279Sport	© 8040-1402Sport				
			Sport Kit			1140-0612	30	30	1,2,13
<b>S5</b>									
	<b>S5 V8 354 Hp</b>	03.07-15	Special-Active	© 8245-1264	© 8045-1265				
			Sport	© 8240-1279Sport	© 8040-1402Sport				
			Sport Kit			1140-0612	30	30	1,2,13
<b>S6</b>									
	<b>S6 (C4) Sedan / Avant Quattro</b> excl. S6 Plus - V8	94-97	STR.T	© 8650-1007	Ⓝ 8050-1077				
			Sport	86-2149Sport	Ⓝ 80-2630Sport				
	<b>S6 (C5, 4B) Sedan / Avant Quattro</b>	99-03	Sport	82-2516Sport	82-2526Sport				
<b>TT</b>									
	<b>TT (8N) Coupé</b> 2WD	98-09.06	STR.T	© 8750-1062					
			Sport	Ⓜ 8710-1377Sport	80-2805Sport				
			Sport Kit			1140-4531	35	35	1,2,13,17
	Quattro		STR.T	© 8750-1062					
			Sport	Ⓜ 8710-1377Sport	80-2818Sport				
			Sport Kit			1140-4385	25	25	1,2,13,17
	<b>TT (8N) Roadster</b> 2WD	98-09.06	STR.T	© 8750-1062					
			Sport	Ⓜ 8710-1377Sport	80-2805Sport				
			Sport Kit			1140-4532	35	35	1,2,13,17
	Quattro		STR.T	© 8750-1062					
			Sport	Ⓜ 8710-1377Sport	80-2818Sport				
			Sport Kit			1140-4385	25	25	1,2,13,17

MAKE		Year	product range				Lowering up to ..mm		Notes	
Model							Front	Rear		
<b>AUDI - CONTINUED</b>										
TT (8J) Coupé 2WD, excl. Magnetic Ride	06-13	STR.T	Ⓢ 8750-1118	Ⓢ 8050-1128						
		Sport	ⓈⓈ 8741-1515Sport	Ⓢ 8040-1371Sport						
		STR.T Kit			1120-1021	30	30	1,2,13		
		Sport Kit			1140-1021	30	30	1,2,13,17		
		Quattro, excl. Audi Magnetic Ride, TT-S TT-RS	06-13	STR.T	Ⓢ 8750-1118	Ⓢ 8050-1128				
		Sport		ⓈⓈ 8741-1515Sport	Ⓢ 8040-1371Sport					
STR.T Kit				1120-1022	30	30	1,2,13			
TT (8J) Roadster 2WD, excl. Magnetic Ride	06-13	Sport Kit			1140-1022	30	30	1,2,13,17		
		STR.T	Ⓢ 8750-1118	Ⓢ 8050-1128						
		Sport	ⓈⓈ 8741-1515Sport	Ⓢ 8040-1371Sport						
		STR.T Kit			1120-1022	30	30	1,2,13		
		Sport Kit			1140-1022	30	30	1,2,13,17		
		Quattro, excl. Audi Magnetic Ride, TT-S TT-RS	06-13	STR.T	Ⓢ 8750-1118	Ⓢ 8050-1128				
Sport	ⓈⓈ 8741-1515Sport	Ⓢ 8040-1371Sport								
STR.T Kit				1120-1022	30	30	1,2,13			
TT (8S) Coupé & Cabrio; incl. Quattro incl. Sport suspension excl. Audi Magnetic Ride, TT-S TT-RS	01.14-19	Sport Kit			1140-1022	30	30	1,2,13,17		
		Sport	ⓈⓈ 8741-1596Sport	Ⓢ 8240-1306Sport						
		Sport Kit			I.D.					
<b>50</b>										
50	75-77	Sport	86-1922Sport	80-2315Sport						
<b>80</b>										
80 (B2, 81) Sedan 4-cyl. excl. GTE	79-86	STR.T	Ⓢ 8650-1010							
		Sport	86-2066Sport							
80 (B2, 81) Sedan 5-cyl. and TD	80-84	STR.T	Ⓢ 8650-1010							
		Sport	86-2066Sport							
80 (B3, 89) Sedan excl. 2.0E-16V	87-91	STR.T	Ⓢ 8650-1010							
		Sport	86-2066Sport							
		Sport	Ⓢ 8610-1262Sport							
80 (B3, 89) Sedan incl. 2.0E-16V with Audi Sport Suspension	87-91	STR.T	Ⓢ 8650-1010							
		Sport	86-2066Sport							
		Sport	Ⓢ 8610-1262Sport							
80 (B3, 89Q) Quattro	87-91	STR.T	Ⓢ 8650-1010							
		Sport	86-2066Sport	86-2086Sport						
		Sport	Ⓢ 8610-1262Sport							
80 (B4, 8C) Sedan / Avant 2.0, 2.0E-2.8E, 1.9TD(i)	92-95	STR.T	Ⓢ 8650-1010	Ⓢ 8050-1071						
		Sport	86-2066Sport							
		Sport	Ⓢ 8610-1262Sport							
80 (B4, 8C) Sedan / Avant Quattro Rear: damper unit must be removed from car before it can be adjusted	92-95	STR.T	Ⓢ 8650-1010							
		Sport	Ⓢ 8610-1262Sport	Ⓢ 8210-1160Sport						
		Sport	Ⓢ 8610-1262Sport							
80 (B4, 8G) Cabrio	91-00	STR.T	Ⓢ 8650-1010							
		Sport	86-2066Sport							
		Sport	Ⓢ 8610-1262Sport							
80 (B4, 8C) Sedan / Avant 1.9TD(i)	09.91-95	STR.T	Ⓢ 8650-1010	Ⓢ 8050-1071						
		Sport	86-2066Sport							
		Sport	Ⓢ 8610-1262Sport							
80 (B4, 8C) Sedan / Avant Quattro Rear: damper unit must be removed from car before it can be adjusted	09.91-95	STR.T	Ⓢ 8650-1010							
		Sport	86-2066Sport	Ⓢ 8210-1160Sport						
		Sport	Ⓢ 8610-1262Sport							
80 (B4, 8C) Competition Rear: damper unit must be removed from car before it can be adjusted	94-95	STR.T	Ⓢ 8650-1010							
		Sport	86-2066Sport	Ⓢ 8210-1160Sport						
		Sport	Ⓢ 8610-1262Sport							
<b>90</b>										
90 (B3, 89) Sedan	85-91	STR.T	Ⓢ 8650-1010							
		Sport	86-2066Sport							
		Sport	Ⓢ 8610-1262Sport							
		with Audi Sport Suspension	85-91	STR.T	Ⓢ 8650-1010					
		Sport		86-2066Sport						
90 (B3, 89) Sedan 2.3E-20V	89-91	STR.T	Ⓢ 8650-1010							
		Sport	86-2066Sport							
		Sport	Ⓢ 8610-1262Sport							
90 (B3, 89Q) Quattro, excl. 2.3E-20V	83-89	STR.T	Ⓢ 8650-1010							
		Sport	86-2066Sport	86-2086Sport						
		Sport	Ⓢ 8610-1262Sport							
90 (B3, 89Q) Quattro 2.3E-20V	89-91	STR.T	Ⓢ 8650-1010							
		Sport	86-2066Sport	86-2433Sport						
		Sport	Ⓢ 8610-1262Sport							
<b>Coupé</b>										
Coupé (B2, 85), excl. Quattro	80-88	STR.T	Ⓢ 8650-1010							
		Sport	86-2066Sport							
		Sport	Ⓢ 8610-1262Sport							
Coupé (B2, 85Q) Quattro, 2.2E, 2.3E, excl. 20V	83-89	STR.T	Ⓢ 8650-1010							
		Sport	86-2066Sport	86-2086Sport						
		Sport	Ⓢ 8610-1262Sport							

MAKE	Model	Year	product range				Lowering up to ..mm		Notes
							Front	Rear	
<b>AUDI - CONTINUED</b>									
	Coupé (B3, 8B/B4, 8C) 2.0E, 2.3E(-20V), 2.6E, 2.8E	89-95	STR.T Sport	⊗ 8650-1010 86-2066Sport					
	Coupé (B3, 8B) Quattro 2.3E-20V	89-91	STR.T Sport Sport	⊗ 8650-1010 86-2066Sport ⊗ 8610-1262Sport		86-2433Sport			
<b>100</b>									
	100 (C2, 43) Sedan CS Diesel	82-82	Special	▲ 86-2149					
	100 (C3, 44 / C4, 4A) Sedan/Avant Rear: M10 top nut	83-94	Special STR.T Sport	▲ 86-2149 ⊗ 8650-1007 86-2149Sport		Ⓝ 80-2762Sport			
	Rear: M12 top nut		STR.T Sport	⊗ 8650-1007 86-2149Sport		ⓃⓄ 8050-1077 Ⓝ 80-2630Sport			
	100 (C3, 44 / C4, 4A) Sedan/Avant Quattro Rear: M10 top nut	84-92	Special STR.T Sport	▲ 86-2149 ⊗ 8650-1007 86-2149Sport		Ⓝ 80-2762Sport			
	Rear: M12 top nut		STR.T Sport	⊗ 8650-1007 86-2149Sport		ⓃⓄ 8050-1077 Ⓝ 80-2630Sport			
<b>200</b>									
	200 (C2, 43) 5E, 5T	80-82	Special	▲ 86-2149					
	200 (C3, 44) Sedan/Avant Rear: M10 top nut	83-90	Special STR.T Sport	▲ 86-2149 ⊗ 8650-1007 86-2149Sport		Ⓝ 80-2762Sport			
	Rear: M12 top nut		STR.T Sport	⊗ 8650-1007 86-2149Sport		ⓃⓄ 8050-1077 Ⓝ 80-2630Sport			
	200 (C3, 44) Sedan/Avant Quattro, Turbo excl. 20V Rear: M10 top nut	84-90	Special STR.T Sport	▲ 86-2149 ⊗ 8650-1007 86-2149Sport		Ⓝ 80-2762Sport			
	Rear: M12 top nut		STR.T Sport	⊗ 8650-1007 86-2149Sport		ⓃⓄ 8050-1077 Ⓝ 80-2630Sport			
	200 (C3, 44) Sedan / Avant Quattro 20V Turbo	89-90	STR.T Sport	⊗ 8650-1007 86-2149Sport		ⓃⓄ 8050-1077 Ⓝ 80-2630Sport			
<b>Quattro</b>									
	Quattro (B2, 85) 2.1 Turbo 200 Hp (ur-quattro)	81-89	Sport	86-2086Sport		86-2087Sport			
<b>V8</b>									
	V8 (D11) 3.6, 4.2	89-94	STR.T Sport	⊗ 8650-1007 86-2149Sport		ⓃⓄ 8050-1077 Ⓝ 80-2630Sport			
<b>BEDFORD</b>									
<b>Blitz</b>									
	Van	75-80	Classic	⚡▲ 80-2119					
<b>CF</b>									
	CF series Front: Pin Pin-attachment	70-90	Classic	⚡▲ 80-2119					
	CF series, with Australian rear suspension Front: Pin Pin-attachment	70-80	Classic	⚡▲ 80-2119		⚡ 80-2134			
<b>Chevanne</b>									
	Chevanne (9 TB 40)	76-77	Classic	⚡□ 80-2275		⚡ 80-1997			
<b>BMW</b>									
<b>02-Series 114/E10/E20</b>									
	1502, 1600-2, 1602, 1802, 2002 incl. Ti, Tii and Turbo	66-77	Sport	86-1519Sport		80-1868Sport			
	Touring 1600, 1800, 2000	71-75	Sport	86-1519Sport		80-1868Sport			
<b>1-Series E81/E82/E87/E88</b>									
	Hatchback (E81, E87), Coupé (E82), Cabrio (E88) 116i, 118i, 120i, 125i, 130i, 135i, 116d, 118d, 120d, 123d, excl. M Coup	09.04-11	Special-Active STR.T Sport STR.T Kit Sport Kit	⊗ 8745-1014L ⊗ 8745-1014R ⊗ 8750-1084L ⊗ 8750-1084R ⚡⊗ 8741-1484LSport ⚡⊗ 8741-1484RSport		⊗ 8245-1015 ⊗ 8250-1024 ⊗ 8240-1231Sport			
						1120-1873 1140-1873	40-50 40-50	30 30	1,2,13 1,2,13,17
<b>1-Series F20/F21</b>									
	1-Series excl. M135i excl. M-Technik, xDrive EDC (Electronic Damper Control)	10.11-18	Special-Active STR.T Sport STR.T Kit Sport Kit	⊗ 8745-1318 ⊗ 8750-1116 ⚡⊗ 8741-1569Sport		⊗ 8245-1319 ⊗ 8250-1045 ⊗ 8240-1294Sport			
						1120-8896-1 1140-8896-1	35 35	35 35	1,2,13 1,2,13,17
	1-Series excl. M135i, with M-Technik excl. xDrive EDC (Electronic Damper Control)	10.11-18	Special-Active Sport Sport Kit	⊗ 8745-1356 ⚡⊗ 8741-1582Sport		⊗ 8245-1357 ⊗ 8240-1298Sport			
						1140-8896-1	35	35	1,2,13,17
	1-Series XDrive excl. EDC	10.11-18	Special-Active Sport	⊗ 8745-1378L ⊗ 8745-1378R ⚡⊗ 8741-1591LSport ⚡⊗ 8741-1591RSport		⊗ 8245-1319 ⊗ 8240-1294Sport			

MAKE		Year	product range				Lowering up to ..mm		Notes	
Model							Front	Rear		
<b>BMW - CONTINUED</b>										
<b>2-Series F22</b>										
2-Series (F22) excl. M235i excl. M-Technik, xDrive EDC (Electronic Damper Control)	11.10-19	Special-Active	Ⓒ 8745-1318	Ⓒ 8245-1319						
		STR.T	Ⓒ 8750-1116	Ⓒ 8250-1045						
		Sport	ⓂⓂⒸ 8741-1569Sport	Ⓒ 8240-1294Sport			1120-8896-1	35	35	1,2,13
		STR.T Kit Sport Kit					1140-8896-1	35	35	1,2,13,17
2-Series (F22) excl. M235i, with M-Technik excl. xDrive EDC (Electronic Damper Control)	11.10-19	Special-Active	Ⓒ 8745-1356	Ⓒ 8245-1357						
		Sport	ⓂⓂⒸ 8741-1582Sport	Ⓒ 8240-1298Sport						
		Sport Kit					1140-8896-1	35	35	1,2,13,17
2-Series (F22) XDrive excl. EDC	11.10-19	Special-Active	Ⓒ 8745-1378L Ⓒ 8745-1378R	Ⓒ 8245-1319						
		Sport	ⓂⓂⒸ 8741-1591LSport ⓂⓂⒸ 8741-1591RSport	Ⓒ 8240-1294Sport						
<b>2-Series F45/F46</b>										
Active Tourer (F45) incl. M-Technik xDrive excl. EDC (Electronic Damper Control)	14-19	Special-Active	Ⓒ 8745-1380L Ⓒ 8745-1380R	Ⓒ 8245-1380						
		Sport	ⓂⓂⒸ 8741-1592LSport ⓂⓂⒸ 8741-1592RSport	Ⓒ 8240-1304Sport						
		Sport Kit							I.D.	
Gran Tourer (F46) incl. M-Technik xDrive excl. EDC (Electronic Damper Control)	14-19	Special-Active	Ⓒ 8745-1380L Ⓒ 8745-1380R	Ⓒ 8245-1380						
		Sport	ⓂⓂⒸ 8741-1592LSport ⓂⓂⒸ 8741-1592RSport	Ⓒ 8240-1304Sport						
		Sport Kit							I.D.	
<b>3-Series E30</b>										
Sedan, excl. M-Technik for McPherson with housing 45 mm	09.82-91	Sport	ⓂⓂⒸ 8641-1029Sport	□ 80-2522Sport						
		Sport Short		□ 80-2522SP1					Lmax -40 mm	
		Sport Short		□ 80-2641Sport					Lmax -30 mm	
Sedan 318is, 323i, 325i, 324td, excl. M-Technik for McPherson with housing 51 mm	09.82-91	Sport	86-2277Sport	□ 80-2522Sport						
		Sport	ⓂⓂⒸ 8641-1021Sport	□ 80-2522Sport						
		Sport Short	ⓂⓂⒸ 8641-1210Sport						Lmax -20 mm	
		Sport Short		□ 80-2641Sport					Lmax -30 mm	
		Sport Short		□ 80-2522SP1					Lmax -40 mm	
Sedan with M-Technik for McPherson with housing 51 mm	09.82-91	Sport	86-2277Sport	□ 80-2522Sport						
		Sport Short	ⓂⓂⒸ 8641-1210Sport						Lmax -20 mm	
		Sport Short		□ 80-2641Sport					Lmax -30 mm	
		Sport Short		□ 80-2522SP1					Lmax -40 mm	
up to 8.88: see info inside cover		Sport	ⓂⓂⒸ 8641-1021Sport	□ 80-2522Sport						
Touring 318i, excl. M-Technik for McPherson with housing 45 mm	09.88-09.89	Sport	ⓂⓂⒸ 8641-1029Sport	□ 80-2522Sport						
		Sport		□ 80-2522Sport						
		Sport Short		□ 80-2641Sport					Lmax -30 mm	
Touring, excl. M-Technik for McPherson with housing 51 mm	87-94	Sport Short		□ 80-2522SP1					Lmax -40 mm	
		Sport	86-2277Sport	□ 80-2522Sport						
		Sport	ⓂⓂⒸ 8641-1021Sport ⓂⓂⒸ 8641-1210Sport	□ 80-2522Sport						
Touring with M-Technik for McPherson with housing 51 mm	87-94	Sport Short		□ 80-2641Sport					Lmax -20 mm	
		Sport Short		□ 80-2522SP1					Lmax -30 mm	
		Sport Short		□ 80-2522SP1					Lmax -40 mm	
		Sport	86-2277Sport	□ 80-2522Sport						
up to 8.88: see info inside cover		Sport	ⓂⓂⒸ 8641-1021Sport	□ 80-2522Sport						
Cabriolet, incl. M-Technik for McPherson with housing 51 mm	86-93	Sport	86-2277Sport	□ 80-2522Sport						
		Sport Short	ⓂⓂⒸ 8641-1210Sport						Lmax -20 mm	
		Sport Short		□ 80-2641Sport					Lmax -30 mm	
		Sport Short		□ 80-2522SP1					Lmax -40 mm	
up to 8.88: see info inside cover		Sport	ⓂⓂⒸ 8641-1021Sport	□ 80-2522Sport						
Sedan / Touring 325iX	85-92	Sport	ⓂⓂⒸ 8641-1144Sport	□ 80-2522Sport						
		Sport Short		□ 80-2641Sport					Lmax -30 mm	
		Sport Short		□ 80-2522SP1					Lmax -40 mm	
<b>3-Series E36</b>										
Sedan 316i, 318i, incl. M-Technik Front: with bracket for anti-roll bar attachment	90-09.91	Special		80-2653						
		STR.T	Ⓒ 8750-1011L Ⓒ 8750-1011R	Ⓒ 8250-1002						
		Sport		Ⓒ 8240-1115Sport						
Sedan 320i, 325i, 325td, incl. M-Technik Front: with bracket for anti-roll bar attachment	90-09.91	STR.T		Ⓒ 8250-1002						
		Sport		Ⓒ 8240-1115Sport						
Coupé 320i, 325i, incl. M-Technik Front: with bracket for anti-roll bar attachment	90-09.91	STR.T		Ⓒ 8250-1002						
		Sport		Ⓒ 8240-1115Sport						
Sedan 316i, 318i, 318is, 318tds, incl. M-Technik	10.91-98	Special		80-2653						
		STR.T	Ⓒ 8750-1011L Ⓒ 8750-1011R	Ⓒ 8250-1002						
		Sport		Ⓒ 8240-1115Sport						
		STR.T Kit					1120-8251	40	15	1,2,13

MAKE		product range				Lowering up to ..mm		Notes
Model	Year					Front	Rear	
<b>BMW - CONTINUED</b>								
Coupé 316i, 318is, incl. M-Technik	10.91-98	Special		80-2653				
		STR.T	Ⓢ 8750-1011L Ⓢ 8750-1011R	Ⓢ 8250-1002				
		Sport		Ⓢ 8240-1115Sport				
		STR.T Kit			1120-8251	40	15	1,2,13
Sedan 320i, 325i, 325td, incl. M-Technik 1992: only for cars with plastic cover 72 mm on top of the upper attachment	10.91-05.92	STR.T		Ⓢ 8250-1002				
		Sport		Ⓢ 8240-1115Sport				
Coupé 320i, 325i, incl. M-Technik 1992: only for cars with plastic cover 72 mm on top of the upper attachment	10.91-05.92	STR.T		Ⓢ 8250-1002				
		Sport		Ⓢ 8240-1115Sport				
Sedan 320i, 323i, 325i, 328i, 325td/s, incl. M-Technik 1992: only for cars with plastic cover 32 mm on top of the upper attachment	06.92-99	Special		80-2653				
		STR.T	Ⓢ 8750-1010L Ⓢ 8750-1010R	Ⓢ 8250-1002				
		Sport	ⓈⓈ 8741-1272LSport ⓈⓈ 8741-1272RSport	Ⓢ 8240-1115Sport				
		STR.T Kit			1120-8242	40	15	1,2,13
Coupé 320i, 323i, 325i, 328i, incl. M-Technik 1992: only for cars with plastic cover 32 mm on top of the upper attachment	06.92-99	Special		80-2653				
		STR.T	Ⓢ 8750-1010L Ⓢ 8750-1010R	Ⓢ 8250-1002				
		Sport	ⓈⓈ 8741-1272LSport ⓈⓈ 8741-1272RSport	Ⓢ 8240-1115Sport				
		STR.T Kit			1120-8242	40	15	1,2,13
Cabriolet 318i, incl. M-Technik	92-99	STR.T	Ⓢ 8750-1010L Ⓢ 8750-1010R	Ⓢ 8250-1002				
		Sport	ⓈⓈ 8741-1272LSport ⓈⓈ 8741-1272RSport	Ⓢ 8240-1115Sport				
		STR.T Kit			1120-9292	40	10	1,2,13
		Sport Kit			1140-9292	40	10	1,2,13,17
Cabriolet 320i, 323i, 325i, 328i, incl. M-Technik	10.91-99	STR.T	Ⓢ 8750-1010L Ⓢ 8750-1010R	Ⓢ 8250-1002				
		Sport	ⓈⓈ 8741-1272LSport ⓈⓈ 8741-1272RSport	Ⓢ 8240-1115Sport				
		STR.T Kit			1120-9291	40	10	1,2,13
		Sport Kit			1140-9291	40	10	1,2,13,17
Touring 316i, 318i, incl. M-Technik	94-99	Special		80-2653				
		STR.T	Ⓢ 8750-1010L Ⓢ 8750-1010R	Ⓢ 8250-1002				
		Sport	ⓈⓈ 8741-1272LSport ⓈⓈ 8741-1272RSport	Ⓢ 8240-1115Sport				
		STR.T Kit			1120-7221	35	20	1,2,13
Touring 320i, 323i, 328i, 318/325tds incl. M-Tech	94-99	Special		80-2653				
		STR.T	Ⓢ 8750-1010L Ⓢ 8750-1010R	Ⓢ 8250-1002				
		Sport	ⓈⓈ 8741-1272LSport ⓈⓈ 8741-1272RSport	Ⓢ 8240-1115Sport				
		STR.T Kit			1120-7222	35	20	1,2,13
Compact, excl. M-Technik and 323ti	04.94-01	STR.T	Ⓢ 8750-1011L Ⓢ 8750-1011R					
		Sport		□ 80-2522Sport □ 80-2641Sport				Lmax -30 mm
		Sport Short						
		STR.T Kit						
Compact with M-Technik, excl. 323ti	04.94-00	STR.T	Ⓢ 8750-1011L Ⓢ 8750-1011R					
		Sport Short		□ 80-2641Sport				Lmax -30 mm
Compact 323ti, incl. M-Technik	10.97-00	STR.T	Ⓢ 8750-1010L Ⓢ 8750-1010R					
		Sport	ⓈⓈ 8741-1272LSport ⓈⓈ 8741-1272RSport	□ 80-2522Sport				
<b>3-Series E46</b>								
Sedan Excl. Sport suspension, M-Technik, -Models	98-05	Special-Active	Ⓢ 8745-1022L Ⓢ 8745-1022R	Ⓢ 8245-1023				
		STR.T	Ⓢ 8750-1029L Ⓢ 8750-1029R	Ⓢ 8050-1051				
316i, 318i, 320i, 323i, 325i, 328i, 330i, 318d, 320d, 330d		Sport	ⓈⓈ 8741-1390LSport ⓈⓈ 8741-1390RSport	Ⓢ 8040-1250Sport				
		STR.T Kit			1120-4851	35	20	1,2,13
With Sport suspension, M-Technik, excl. -Models		Sport Kit			1140-4851	35	20	1,2,13,17
		Special-Active	Ⓢ 8745-1022L Ⓢ 8745-1022R	Ⓢ 8245-1024				
		STR.T	Ⓢ 8750-1029L Ⓢ 8750-1029R	Ⓢ 8050-1051				
		Sport	ⓈⓈ 8741-1390LSport ⓈⓈ 8741-1390RSport	Ⓢ 8040-1271Sport				

MAKE		product range				Lowering up to ..mm		Notes		
Model	Year					Front	Rear			
<b>BMW - CONTINUED</b>										
316i, 318i, 320i, 323i, 325i, 328i, 330i, 318d, 320d, 330d	98-05	STR.T Kit				1120-4851	35	20	1,2,13	
		Sport Kit				1140-4852	35	20	1,2,13,17	
<b>Touring</b> With Sport suspension, M-Technik, excl. -Models		Special-Active	Ⓞ 8745-1022L Ⓞ 8745-1022R		Ⓞ 8245-1024					
		STR.T	Ⓞ 8750-1029L Ⓞ 8750-1029R		Ⓞ 8050-1051					
		Sport	ⓂⓄ 8741-1390LSport ⓂⓄ 8741-1390RSport		Ⓞ 8040-1271Sport					
316i, 318i, 320i, 325i, 328i, 330i, 318d, 320d		98-05	STR.T Kit				1120-4191	35	20	1,2,13
			Sport Kit				1140-4191	35	20	1,2,13
330d			STR.T Kit				1120-4192	35	20	1,2,13
			Sport Kit				1140-4192	35	20	1,2,13
<b>Cabriolet</b> Incl. Sport suspension, M-Technik		98-05	Special-Active	Ⓞ 8745-1022L Ⓞ 8745-1022R		Ⓞ 8245-1024				
	STR.T		Ⓞ 8750-1029L Ⓞ 8750-1029R		Ⓞ 8050-1051					
	Sport		ⓂⓄ 8741-1390LSport ⓂⓄ 8741-1390RSport		Ⓞ 8040-1271Sport					
318Ci, 320Ci, 323Ci, 325Ci, 330Ci, 320Cd, 330Cd	05.99-05	STR.T Kit				1120-4851	35	20	1,2,13	
		Sport Kit				1140-4851	35	20	1,2,13,17	
<b>Coupé</b> excl. -models		Special-Active	Ⓞ 8745-1022L Ⓞ 8745-1022R		Ⓞ 8245-1024					
		STR.T	Ⓞ 8750-1029L Ⓞ 8750-1029R		Ⓞ 8050-1051					
		Sport	ⓂⓄ 8741-1390LSport ⓂⓄ 8741-1390RSport		Ⓞ 8040-1271Sport					
316Ci, 318Ci, 320Ci, 323Ci, 325Ci, 328Ci, 330Ci, 320Cd, excl. 330Cd		05.99-05	STR.T Kit				1120-4841	35	10	1,2,13
			Sport Kit				1140-4841	35	10	1,2,13,17
<b>Compact</b> incl. M-Technik		06.01-05	Special-Active	Ⓞ 8745-1022L Ⓞ 8745-1022R		Ⓞ 8245-1024				
			STR.T	Ⓞ 8750-1029L Ⓞ 8750-1029R		Ⓞ 8050-1051				
			Sport	ⓂⓄ 8741-1390LSport ⓂⓄ 8741-1390RSport		Ⓞ 8040-1271Sport				
316ti, 318ti, 325ti, 318id, 320id	06.01-05	STR.T Kit				1120-4841	35	10	1,2,13	
		Sport Kit				1140-4841	35	10	1,2,13,17	
<b>Sedan, Touring 325xi, 330xi, 330xd</b>	00-05	Sport	ⓂⓄ 8741-1481LSport ⓂⓄ 8741-1481RSport		Ⓞ 8040-1343Sport					
<b>3-Series E90/91/92/93</b>										
<b>Sedan (E90)</b> excl. xi, xd, xDrive (4WD), incl. M-Technik	05-11	Special-Active	Ⓞ 8745-1014L Ⓞ 8745-1014R		Ⓞ 8245-1094					
		STR.T	Ⓞ 8750-1084L Ⓞ 8750-1084R		Ⓞ 8250-1026					
		Sport	ⓂⓄ 8741-1484LSport ⓂⓄ 8741-1484RSport		Ⓞ 8240-1236Sport					
	316i, 318i, 320(s)i, 325i, 330i, 335i, 316d, 318d, 320d, 325d, 330d	05-11	STR.T Kit				1120-1871	35	20	1,2,13
			Sport Kit				1140-1871	35	20	1,2,13,17
			STR.T Kit				1120-1875	40	20	1,2,13
	335d	05-11	Sport Kit				1140-1875	40	20	1,2,13,17
	<b>Touring (E91)</b> excl. xi, xd, xDrive (4WD), incl. M-Technik	06-11	Special-Active	Ⓞ 8745-1014L Ⓞ 8745-1014R		Ⓞ 8245-1094				
			STR.T	Ⓞ 8750-1084L Ⓞ 8750-1084R		Ⓞ 8250-1026				
			Sport	ⓂⓄ 8741-1484LSport ⓂⓄ 8741-1484RSport		Ⓞ 8240-1236Sport				
316i, 318i, 320(s)i, 325i, 330i, 335i, 316d, 318d, 320d, 325d, 330d		06-11	STR.T Kit				1120-1872	35	20	1,2,13
			Sport Kit				1140-1872	35	20	1,2,13,17
			STR.T Kit				1120-1876	35	20	1,2,13
335d	06-11	Sport Kit				1140-1876	35	20	1,2,13,17	
<b>Coupé (E92)</b> excl. xi, xd, xDrive (4WD), incl. M-Technik	06-11	Special-Active	Ⓞ 8745-1014L Ⓞ 8745-1014R		Ⓞ 8245-1094					
		STR.T	Ⓞ 8750-1084L Ⓞ 8750-1084R		Ⓞ 8250-1026					
		Sport	ⓂⓄ 8741-1484LSport ⓂⓄ 8741-1484RSport		Ⓞ 8240-1236Sport					
	320i, 325i, 330i, 335i, 320d, 325d, 330d	06-11	STR.T Kit				1120-1871	35	25	1,2,13
			Sport Kit				1140-1871	35	25	1,2,13,17
			STR.T Kit				1120-1875	40	20	1,2,13
335d	06-11	Sport Kit				1140-1875	40	20	1,2,13,17	
<b>Cabrio (E93)</b> incl. M-Technik	07-11	Special-Active	Ⓞ 8745-1014L Ⓞ 8745-1014R		Ⓞ 8245-1094					
		STR.T	Ⓞ 8750-1084L Ⓞ 8750-1084R		Ⓞ 8250-1026					
		Sport	ⓂⓄ 8741-1484LSport		Ⓞ 8240-1236Sport					
			ⓂⓄ 8741-1484RSport							

MAKE		Year	product range				Lowering up to ..mm		Notes
Model							Front	Rear	
<b>BMW - CONTINUED</b>									
320i, 325i, 330i, 335i, 320d, 325d, 330d			STR.T Kit			1120-1872	40	20	1,2,13
			Sport Kit			1140-1872	40	20	1,2,13,17
335d			STR.T Kit			1120-1876	40	20	1,2,13
			Sport Kit			1140-1876	40	20	1,2,13,17
<b>Sedan, Touring, Coupé (E90/E91/E92) xi/xd/xDrive</b> incl. M-Technik		05-11	Special-Active	Ⓒ 8745-1234L Ⓒ 8745-1234R		Ⓒ 8245-1015			
			Sport	ⓂⓂⒸ 8741-1535LSport ⓂⓂⒸ 8741-1535RSport		Ⓒ 8240-1236Sport			
<b>3-Series F30/F31/F34</b>									
<b>Sedan (F30) excl. M-Technik, M3</b> excl. xDrive EDC (Electronic Damper Control)		11-18	Special-Active	Ⓒ 8745-1318		ⓃⒸ 8245-1319			
			STR.T	Ⓒ 8750-1116		ⓃⒸ 8250-1045			
			Sport	ⓂⓂⒸ 8741-1569Sport		ⓃⒸ 8240-1294Sport			
Front axle load up to 965 kg			STR.T Kit			1120-8878-1	30	30	1,2,13
			Sport Kit			1140-8878-1	30	30	1,2,13,17
Front axle load as from 966 kg			STR.T Kit			1120-8878-2	30	30	1,2,13
			Sport Kit			1140-8878-2	30	30	1,2,13,17
<b>Sedan (F30) with M-Technik, excl. M3</b> excl. xDrive EDC (Electronic Damper Control)		11-18	Special-Active	Ⓒ 8745-1356		ⓃⒸ 8245-1357			
			Sport	ⓂⓂⒸ 8741-1582Sport		ⓃⒸ 8240-1298Sport			
Front axle load up to 965 kg			Sport Kit			1140-8878-1	30	30	1, 2, 13, 17
Front axle load as from 966 kg			Sport Kit			1140-8878-2	30	30	1, 2, 13, 17
<b>Sedan (F30) XDrive</b> excl. EDC		11-18	Special-Active	Ⓒ 8745-1378L Ⓒ 8745-1378R		Ⓒ 8245-1319			
			Sport	ⓂⓂⒸ 8741-1591LSport ⓂⓂⒸ 8741-1591RSport		Ⓒ 8240-1294Sport			
			Sport Kit			1140-8832-1	40	40	1,2,13,17
<b>Sedan (F30) Hybrid 330e</b> Excl. VDC		11-18	Special-Active	Ⓒ 8745-1356		Ⓒ 8245-1357			
			Sport	ⓂⓂⒸ 8741-1582Sport		Ⓒ 8240-1298Sport			
<b>Touring (F31) excl. M-Technik, M3</b> excl. xDrive EDC (Electronic Damper Control)		12-18	Special-Active	Ⓒ 8745-1318		ⓃⒸ 8245-1319			
			STR.T	Ⓒ 8750-1116		ⓃⒸ 8250-1045			
			Sport	ⓂⓂⒸ 8741-1569Sport		ⓃⒸ 8240-1294Sport			
Front axle load up to 965 kg			STR.T Kit			1120-8878-3	25	25	1,2,13
			Sport Kit			1140-8878-3	25	25	1,2,13,17
Front axle load as from 966 kg			STR.T Kit			1120-8878-4	25	25	1,2,13
			Sport Kit			1140-8878-4	25	25	1,2,13,17
<b>Touring (F31) with M-Technik, excl. M3</b> excl. xDrive EDC (Electronic Damper Control)		12-18	Special-Active	Ⓒ 8745-1356		Ⓒ 8245-1357			
			Sport	ⓂⓂⒸ 8741-1582Sport		Ⓒ 8240-1298Sport			
Front axle load up to 965 kg			Sport Kit			1140-8878-3	25	25	1,2,13,17
Front axle load as from 966 kg			Sport Kit			1140-8878-4	25	25	1,2,13,17
<b>Touring (F31) XDrive</b> excl. EDC		12-18	Special-Active	Ⓒ 8745-1378L Ⓒ 8745-1378R		Ⓒ 8245-1319			
			Sport	ⓂⓂⒸ 8741-1591LSport ⓂⓂⒸ 8741-1591RSport		Ⓒ 8240-1294Sport			
			Sport Kit			1140-8832-2	45	30	1,2,13,17
<b>GT (F34) excl. M-Technik</b> excl. xDrive EDC (Electronic Damper Control)		12-18	Special-Active	Ⓒ 8745-1318		ⓃⒸ 8245-1319			
			STR.T	Ⓒ 8750-1116		ⓃⒸ 8250-1045			
			Sport	ⓂⓂⒸ 8741-1569Sport		ⓃⒸ 8240-1294Sport			
Front axle load up to 965 kg			STR.T Kit			1120-8878-3	30	30	1,2,13
			Sport Kit			1140-8878-3	30	30	1,2,13,17
Front axle load as from 966 kg			STR.T Kit			1120-8878-4	30	30	1,2,13
			Sport Kit			1140-8878-4	30	30	1,2,13,17
<b>GT (F34) with M-Technik</b> excl. xDrive EDC (Electronic Damper Control)		12-18	Special-Active	Ⓒ 8745-1356		ⓃⒸ 8245-1357			
			Sport	ⓂⓂⒸ 8741-1582Sport		ⓃⒸ 8240-1298Sport			
Front axle load up to 965 kg			STR.T Kit			1120-8878-3	30	30	1,2,13,17
Front axle load as from 966 kg			Sport Kit			1140-8878-4	30	30	1,2,13,17
<b>4-Series (F32/F33/F36)</b>									
<b>4-Series Coupé (F32) / Gran Coupé (F36)</b> incl. M-Technik excl. xDrive EDC (Electronic Damper Control)		10.12-19	Special-Active	Ⓒ 8745-1356		Ⓒ 8245-1357			
			Sport	ⓂⓂⒸ 8741-1582Sport		Ⓒ 8240-1298Sport			
Front axle load up to 965 kg			Sport Kit			1140-8878-1	15	10	1,2,13,17
Front axle load as from 966 kg			Sport Kit			1140-8878-2	15	10	1,2,13,17
<b>4-Series Cabrio (F33)</b> incl. M-Technik excl. xDrive EDC (Electronic Damper Control)		04.13-19	Special-Active	Ⓒ 8745-1356		Ⓒ 8245-1385			
			Sport	ⓂⓂⒸ 8741-1582Sport		Ⓒ 8240-1307Sport			
Front axle load up to 965 kg			Sport Kit			1140-28878-3	15	10	1,2,13,17
Front axle load as from 966 kg			Sport Kit			1140-28878-4	15	10	1,2,13,17
<b>M3</b>									
<b>E30</b>		85-91	Sport	86-2277SP1					
			Sport Short	ⓂⓂⒸ 8641-1210Sport					Lmax -20 mm
			Sport Short			□ 80-2522SP1			Lmax -40 mm
<b>E36 3.0</b> KONI Sport: Front: for original struts only		03.93-99	Sport	ⓂⓂⒸ 8641-1342Sport		Ⓒ 8240-1115Sport			
			Sport Kit			1140-9101	40	10	1,2,13,17
<b>E36 3.2</b> KONI Sport: Front: for original struts only		03.93-99	Sport	ⓂⓂⒸ 8641-1342Sport		Ⓒ 8240-1115Sport			
			Sport Kit			1140-9102	40	10	1,2,13,17
<b>E46</b>		00-06	Sport	ⓂⓂⒸ 8741-1438LSport ⓂⓂⒸ 8741-1438RSport		Ⓒ 8240-1203Sport			
			Sport Kit			1140-3641	30	20	1,2,13,17



MAKE	Model	Year	product range				Lowering up to ..mm		Notes	
							Front	Rear		
<b>BMW - CONTINUED</b>										
<b>5-Series E34</b>										
	<b>Sedan 518i, 520i, excl. M-Technik, EDC</b> only for cars with plastic cover 32 mm on top of the upper attachment	88-07-90	Sport			Ⓝ 8240-1076Sport				
	only for cars with plastic cover 72 mm on top of the upper attachment		Sport	ⓂⓃ 8641-1157Sport			Ⓝ 8240-1076Sport			
	<b>Sedan 518i, 520i, excl. M-Technik, EDC</b> only for cars with plastic cover 32 mm on top of the upper attachment	08.90-08.92	Sport			Ⓝ 8240-1076Sport				
	only for cars with plastic cover 72 mm on top of the upper attachment		Sport	ⓂⓃ 8641-1224Sport			Ⓝ 8240-1076Sport			
	<b>Sedan 525i, 530i, 535i, 524td excl. M-Technik, EDC</b> only for cars with top nut M 12	88-07-90	Sport			ⓂⓃ 8641-1157Sport				
	<b>Sedan 525i, 530i, 535i excl. M-Technik, iX, EDC</b> only for cars with top nut M 14 and plastic cover 72 mm on top of the upper attachment	08.90-08.92	Sport			ⓂⓃ 8641-1224Sport				
	<b>Sedan 524td, 525tds, excl. M-Technik, EDC</b> only for cars with top nut M 14 and plastic cover 72 mm on top of the upper attachment	08.90-08.92	Sport			ⓂⓃ 8641-1224Sport				
	<b>Sedan 525i, 525td, 525tds excl. M-Technik, iX, EDC</b> only for cars with plastic cover 32 mm on top of the upper attachment	09.92-95	Sport						Ⓝ 8240-1076Sport	
	<b>Sedan 530i, 540i, excl. M-Technik, iX, EDC</b>	09.92-95	Sport			ⓂⓃ 8641-1224Sport			Ⓝ 8240-1076Sport	
	<b>Touring 518i, 520i, 525td</b> only for cars with plastic cover 32 mm on top of the upper attachment	92-07.96	Sport						Ⓝ 8240-1076Sport	
	only for cars with plastic cover 72 mm on top of the upper attachment		Sport	ⓂⓃ 8641-1224Sport			Ⓝ 8240-1076Sport			
	<b>Touring 525i, 530i, 540i, 525tds, excl. iX-models</b>	92-07.96	Sport			ⓂⓃ 8641-1224Sport				
<b>5-Series E39</b>										
	<b>Sedan 4 / 6-cyl.</b> excl. M-Technik, EDC (Electronic Damper Control) and self-leveling systems	12.95-03	Special-Active	Ⓝ 8745-1053		Ⓝ 8245-1054				
			STR.T	Ⓝ 8750-1071		Ⓝ 8250-1021				
			Sport			M2ⓂⓃⓃ 8240-1156Sport				
			Sport Kit				1120-7421	40	15	1,2,13,15
	M-Technik, excl. EDC (Electronic Damper Control) and self-leveling systems		Special-Active	Ⓝ 8745-1053		Ⓝ 8245-1054				
			STR.T	Ⓝ 8750-1071		Ⓝ 8250-1021				
			Sport			M2ⓂⓃⓃ 8240-1156Sport				
			STR.T Kit				1120-7423	30	15	Excl 525D, 530D
	Sport Kit					1140-7421	40	15	1,2,13,15,17	
							1140-7423	30	15	Excl 525D, 530D
	<b>Sedan 8-cyl.</b> incl. M-Technik, excl. EDC (Electronic Damper Control) and self-leveling systems	04.96-03	STR.T	Ⓝ 8750-1074		Ⓝ 8250-1021				
			Sport	ⓂⓃ 8741-1372Sport		M2ⓂⓃⓃ 8240-1156Sport				
			STR.T Kit				1120-7641	30	15	1,2,13,15
			Sport Kit				1140-7641	30	15	1,2,13,15,17
	<b>Touring 4 / 6 cyl.</b> incl. M-Technik, excl. EDC (Electronic Damper Control) and self-leveling systems	03.97-04	Special-Active	Ⓝ 8745-1053		Ⓝ 8245-1056				
			STR.T	Ⓝ 8750-1071						
			Sport			Ⓝ▲ 8240-1157Sport				
			Sport Kit				1140-7911	40	15	1,2,13,15,17,26
	<b>Touring 8-cyl.</b> excl. M-Technik, EDC (Electronic Damper Control) and self-leveling systems	03.97-04	STR.T	Ⓝ 8750-1074						
			Sport	ⓂⓃ 8741-1372Sport		Ⓝ▲ 8240-1157Sport				
			Sport Kit				1140-7642	30	0	1,12,13,15,17,26
			STR.T	Ⓝ 8750-1074						
	M-Technik, excl. EDC (Electronic Damper Control) and self-leveling systems		Sport	ⓂⓃ 8741-1372Sport		Ⓝ▲ 8240-1157Sport				
			Sport Kit				1140-7643	30	0	1,12,13,15,17,26
<b>5-Series E6*</b>										
	<b>Sedan (E60) 520i, 523i, 525i, 530i, 520d</b> excl. xi, xd, xDrive (AWD) EDC (Electronic Damper Control)	06.03-11.09	Special-Active	Ⓝ 8745-1003		Ⓝ 8245-1004				
			Sport	ⓂⓃ 8741-1476Sport		Ⓝ 8240-1219Sport				
			Sport Kit				1140-2551	30	30	1,2,13,15,17
	For vehicles with rear air suspension, excl. EDC (Electronic Damper Control)		Sport Kit						1140-2553	
	<b>Sedan (E60) 540i, 545i, 550i, 525d, 530d, 535d</b> excl. xi, xd, xDrive (AWD) EDC (Electronic Damper Control)	06.03-11.09	Special-Active	Ⓝ 8745-1003		Ⓝ 8245-1004				
			Sport	ⓂⓃ 8741-1476Sport		Ⓝ 8240-1219Sport				
			Sport Kit				1140-2552	30	30	1,2,13,15,17
	For vehicles with rear air suspension, excl. EDC (Electronic Damper Control)		Sport Kit						1140-2554	
	<b>Touring (E61) 520i, 523i, 525i, 530i, 520d</b> incl. rear air suspension, M-Technik excl. xi, xd, xDrive (AWD) EDC (Electronic Damper Control)	06.03-10	Special-Active	Ⓝ 8745-1003		Ⓝ 8245-1041				
			Sport	ⓂⓃ 8741-1476Sport		Ⓝ▲ 8240-1233Sport				
			Sport Kit				1140-2555	30	-	1,2,13,15,17
	<b>Touring (E61) 540i, 545i, 550i, 525d, 530d, 535d</b> incl. rear air suspension, M-Technik excl. xi, xd, xDrive (AWD) EDC (Electronic Damper Control)	06.03-10	Special-Active	Ⓝ 8745-1003		Ⓝ 8245-1041				
			Sport	ⓂⓃ 8741-1476Sport		Ⓝ▲ 8240-1233Sport				
			Sport Kit				1140-2556	30	-	1,2,13,15,17
<b>5-Series F**</b>										
	<b>Sedan (F10)</b> incl. M-Technik excl. xDrive EDC (Electronic Damper Control)	09-17	Special-Active	Ⓝ 8245-1302L Ⓝ 8245-1302R		Ⓝ 8245-1303				
			Sport	ⓂⓃ 8241-1289LSport ⓂⓃ 8241-1289RSport		ⓂⓃ 8241-1290Sport				
			Sport Kit				1140-9471	35	35	excl 535D, 550i
			Sport Kit				1140-9472			535D, 550i only
	<b>Sedan Long (F18) - China market</b> incl. M-Technik excl. xDrive EDC (Electronic Damper Control)	09-17	Special-Active	Ⓝ 8245-1302L Ⓝ 8245-1302R		Ⓝ 8245-1303				
			Sport	ⓂⓃ 8241-1289LSport		ⓂⓃ 8241-1290Sport				

MAKE		Year	product range				Lowering up to ..mm		Notes
Model							Front	Rear	
<b>BMW - CONTINUED</b>									
Touring (F11) incl. M-Technik excl. xDrive EDC (Electronic Damper Control)	09-17	Special-Active	ⓂⓄ 8241-1289RSport Ⓞ 8245-1302L Ⓞ 8245-1302R	Ⓞ 8245-1320					
		Sport	ⓂⓄ 8241-1289LSport ⓂⓄ 8241-1289RSport	Ⓞ ▲ 8240-1295Sport					
		Sport Kit			1140-9473	35	15	excl 535D, 550i	
		Sport Kit			1140-9476	35	15	535D, 550i only	
<b>M5</b>									
E39	98-03	Sport	ⓂⓄ 8741-1372Sport	M2ⓂⓄⓄ 8240-1156Sport					
		Sport Kit			1140-4411	25	0	1,2,13,17	
<b>7-Series E32</b>									
Sedan 730i, 730i-V8, 735i, 740i excl. M-Technik and EDC	03.88-07.90	Sport	ⓂⓄ 8641-1157Sport						
Sedan 750i excl. M-Technik and EDC	03.88-07.90	Sport	ⓂⓄ 8641-1157Sport	△					
Sedan 730i, 730i-V8, 735i, 740i excl. M-Technik and EDC	08.90-07.94	Sport	ⓂⓄ 8641-1224Sport						
Sedan 750i excl. M-Technik and EDC	08.90-07.94	Sport	ⓂⓄ 8641-1224Sport	△					
<b>X1</b>									
X1 (F48) incl. xDrive incl. M-Technik, excl. EDC	11.14-	Special-Active	Ⓞ 8745-1380L Ⓞ 8745-1380R	Ⓞ 8245-1380					
		Sport	ⓂⓄ 8741-1592LSport ⓂⓄ 8741-1592RSport	Ⓞ 8240-1304Sport					
<b>X2</b>									
X2 (F39)	11.17-	Special-Active		I.D.	I.D.				
<b>X3</b>									
X3 (E83)	03-10	Special-Active	Ⓞ 8745-1309L Ⓞ 8745-1309R	Ⓞ 8245-1310					
	X3 (F25) incl. M-Technik, excl. EDC	10-17	Special-Active	Ⓞ 8745-1381L Ⓞ 8745-1381R	Ⓞ 8245-1381				
<b>X4</b>									
X4 (F26) incl. M-Technik, excl. EDC	14-19	Special-Active	Ⓞ 8745-1381L Ⓞ 8745-1381R	Ⓞ 8245-1381					
<b>X5</b>									
X5 (E70) excl. X5M, M50dX incl. M-Technik, excl. VDC and air suspension	07-13	Special-Active	Ⓞ 8745-1342	Ⓞ 8245-1343L Ⓞ 8245-1343R					
<b>X6</b>									
X6 (E71) excl. X6M, M50dX incl. M-Technik, excl. VDC and air suspension	08-14	Special-Active	Ⓞ 8745-1342	Ⓞ 8245-1343L Ⓞ 8245-1343R					
<b>Z-Series</b>									
Z1	89-91	Sport	86-2277Sport	□ 80-2522Sport					
		Sport	ⓂⓄ 8641-1021Sport						
Z3 Roadster 1.8i, 1.9i incl. M-Technik	94-03	Sport	ⓂⓄ 8741-1338LSport ⓂⓄ 8741-1338RSport	Ⓞ 8040-1217Sport					
		Sport Kit			1140-7541	30	30	1,2,13,17	
Z3 Roadster 2.0, 2.2, 2.8, 3.0 incl. M-Technik	96-03	Sport	ⓂⓄ 8741-1338LSport ⓂⓄ 8741-1338RSport	Ⓞ 8040-1217Sport					
		Sport Kit			1140-7542	30	30	1,2,13,17	
Z3 M-Roadster Front: for original struts only	96-03	Sport	ⓂⓄ 8641-1342Sport	Ⓞ 8040-1217Sport					
		Sport Kit			1140-5201	30	30	1,2,13,17	
Z3 Coupé 2.8, 3.0 incl. M-Technik	97-03	Sport	ⓂⓄ 8741-1338LSport ⓂⓄ 8741-1338RSport	Ⓞ 8040-1217Sport					
		Sport Kit			1140-7542	30	30	1,2,13,17	
Z3 M-Coupé Front: for original struts only	97-02	Sport	ⓂⓄ 8641-1342Sport	Ⓞ 8040-1217Sport					
		Sport Kit			1140-5201	30	30	1,2,13,17	
Z4 Roadster (E85) 2.0i, 2.5i, 2.5si, 3.0si	03-12.08	Sport	ⓂⓄ 8741-1450LSport ⓂⓄ 8741-1450RSport	Ⓞ 8240-1208Sport					
		Sport Kit			1140-2691	35	35	1,2,13,17	
Z4 Coupé (E86) 3.0si, excl. M Coupé	06-09	Sport	ⓂⓄ 8741-1450LSport ⓂⓄ 8741-1450RSport	Ⓞ 8240-1208Sport					
		Sport Kit			1140-2691	35	35	1,2,13,17	
Z4 (E89) excl. 3.5iS excl. M-Technik and VDC	08-16	Sport	ⓂⓄ 8741-1587LSport ⓂⓄ 8741-1587RSport	Ⓞ 8240-1302Sport					
		Sport Kit			1140-9871	30	30	1, 2, 13, 17	
<b>BUICK</b>									
<b>Century</b>									
Sedan / Coupé	70-77	Classic	ⓂⓄ 8040-1087	ⓂⓄ □ 8040-1088					
Wagon	73-77	Classic	ⓂⓄ 8040-1087						
<b>Electra</b>									
Electra	71-76	Classic	ⓂⓄ 8040-1087						
Electra rear wheel drive	77-85	Classic	ⓂⓄ 8040-1087	ⓂⓄ □ 8040-1088					
Electra Wagon	85-90	Classic	ⓂⓄ 8040-1087	ⓂⓄ □ 8040-1088					
<b>Estate</b>									
Estate	71-76	Classic	ⓂⓄ 8040-1087						
Estate rear wheel drive	77-85	Classic	ⓂⓄ 8040-1087	ⓂⓄ □ 8040-1088					

MAKE		Year	product range				Lowering up to ..mm		Notes
Model							Front	Rear	
<b>BUICK - CONTINUED</b>									
<b>Le Sabre</b>									
LeSabre		71-76	Classic	⚡Ⓞ 8040-1087					
LeSabre rear wheel drive		77-85	Classic	⚡Ⓞ 8040-1087	⚡Ⓞ□ 8040-1088				
Wagon		85-90	Classic	⚡Ⓞ 8040-1087	⚡Ⓞ□ 8040-1088				
<b>Regal</b>									
Regal excl. Regal GS, excl. interactive drive control system		09-13	Sport			Ⓞ▲ 8240-1291Sport			
<b>Riviera</b>									
Coupe		71-76	Classic	⚡Ⓞ 8040-1087					
Coupe		77-78	Classic	⚡Ⓞ 8040-1087	⚡Ⓞ□ 8040-1088				
<b>Roadmaster</b>									
Sedan / Wagon		92-96	Classic	⚡Ⓞ 8040-1087	⚡Ⓞ□ 8040-1088				
<b>Skylark</b>									
incl. Special		64-67	Classic		⚡Ⓞ□ 8040-1088				
incl. Special		68-72	Classic	⚡Ⓞ 8040-1087	⚡Ⓞ□ 8040-1088				
incl. Apollo		73-79	Classic	⚡Ⓞ 8040-1087					
Sportwagon		70-72	Classic	⚡Ⓞ 8040-1087	⚡Ⓞ□ 8040-1088				
<b>CADILLAC</b>									
<b>BLS</b>									
BLS Sedan excl. 4 wheel drive		03.06-08	Special-Active	Ⓞ 8745-1010L Ⓞ 8745-1010R		Ⓞ 8245-1011			
			STR.T			Ⓞ 8050-1105			
			Sport	⚡Ⓞ 8741-1479LSport ⚡Ⓞ 8741-1479RSport					
BLS Sedan excl. 4 wheel drive		10.08-09	Special-Active			Ⓞ 8245-1011			
			STR.T			Ⓞ 8050-1105			
			Sport	⚡Ⓞ 8741-1539Sport					
BLS Wagon excl. 4 wheel drive		07-08	Special-Active	Ⓞ 8745-1010L Ⓞ 8745-1010R		Ⓞ 8245-1011			
			STR.T			Ⓞ 8050-1105			
			Sport	⚡Ⓞ 8741-1479LSport ⚡Ⓞ 8741-1479RSport		Ⓞ▲ 8040-1342Sport			
BLS Wagon excl. 4 wheel drive		10.08-09	Special-Active			Ⓞ 8245-1011			
			STR.T			Ⓞ 8050-1105			
			Sport	⚡Ⓞ 8741-1539Sport		Ⓞ▲ 8040-1342Sport			
<b>Calais</b>									
Calais / De Ville		77-84	Classic	⚡Ⓞ 8040-1087	⚡Ⓞ□ 8040-1088				
<b>Catera</b>									
Catera V6 (Opel Omega) Front: for original struts only		97-01	Sport	⚡Ⓞ 8610-1315Sport		80-2591Sport			
<b>CHEVROLET</b>									
<b>Bel Air</b>									
Bel Air, Caprice, Impala, Kingswood Station-Wagon		71-76	Classic	⚡Ⓞ 8040-1087					
<b>Camaro</b>									
Camaro with mono-leaf spring rear		67-69	Classic	⚡ 80-1914		⚡ 80-1915			
Camaro with multi-leaf spring rear		68-69	Classic	⚡ 80-1914		⚡ 80-1953			
Camaro, incl. Z-28		70-81	Classic	⚡Ⓞ 8040-1017		⚡Ⓞ 8040-1018			
Camaro Coupé / Conv (FP-)		82-92	Sport	⚡Ⓞ 8741-1030Sport		Ⓞ 30-1265Sport			rear: on request
Camaro double adjustable alternative		93-02	Sport	N2ⓄⓄⓄ 8241-1139Sport		⚡Ⓞ 8241-1140Sport			
Camaro - V6 & V8 18 19 inch wheels only		10-15	Sport	⚡Ⓞ 8741-1563LSpor ⚡Ⓞ 8741-1563RSpor		⚡Ⓞ▲ 8242-1006SP1 ⚡Ⓞ 8241-1292Sport			On request
Camaro		16-	Sport						I.D.
<b>Caprice</b>									
Caprice Classic, Station-Wagon		77-96	Classic	⚡Ⓞ 8040-1087	⚡Ⓞ□ 8040-1088				
<b>Chevelle</b>									
Chevelle, Malibu, SS 396, SS 454, Green Brier		68-73	Classic	⚡Ⓞ 8040-1087	⚡Ⓞ□ 8040-1088				
Chevelle Laguna Coupé and Estate		73-77	Classic	⚡Ⓞ 8040-1087	⚡Ⓞ□ 8040-1088				
Chevelle Malibu Classic		77-77	Classic	⚡Ⓞ 8040-1087	⚡Ⓞ□ 8040-1088				
<b>Chevy II</b>									
Nova with multi-leaf spring rear		68-74	Classic	⚡Ⓞ 8040-1087	⚡Ⓞ□ 8040-1088				
Nova with multi-leaf spring rear		75-79	Classic	⚡Ⓞ 8040-1087					
<b>Corvette</b>									
Corvette C2 Coupé / Convertible		63-67	Classic	⚡Ⓞ 8040-1019	⚡Ⓞ□ 8040-1020				
Corvette C3 Coupé / Convertible		68-83	Classic	⚡Ⓞ 8040-1019	⚡Ⓞ□ 8040-1020				
Corvette C5 excl. electronically adjustable suspension		97-04	Sport	⚡Ⓞ 3013-1023Sport	⚡Ⓞ 3013-1024Sport				On request
Corvette C6 excl. electronically adjustable suspension		05-13	Sport	⚡Ⓞ 3013-1023Sport	⚡Ⓞ 3013-1024Sport				On request
Corvette C7, excl. Z06, ZR1 excl. MagneRide		14-19	Sport	⚡Ⓞ 8241-1306Sport	⚡Ⓞ 8241-1307Sport				I.D.
<b>Cruze</b>									
Cruze Sedan, Hatchback & Stationwagon		08-16	Sport	⚡Ⓞ 8741-1568LSport ⚡Ⓞ 8741-1568RSport		Ⓞ 8240-1293Sport			

MAKE	Model	Year	product range				Lowering up to ..mm		Notes
							Front	Rear	
<b>CHEVROLET - CONTINUED</b>									
<b>El Camino</b>									
	El Camino, Monte Carlo	68-77	Classic	⌘Ⓞ 8040-1087	⌘ⓄⓀ 8040-1088				
<b>Impala</b>									
	Impala	65-76	Classic	⌘Ⓞ 8040-1087					
	Impala	77-90	Classic	⌘Ⓞ 8040-1087	⌘ⓄⓀ 8040-1088				
<b>K1500 / K2500 / K3500</b>									
	K1500 / K2500 / K3500 Pickup AWD	87-99	eavy Track	82-2372	82-2384				
	K1500 / K2500 Suburban AWD	92-98	eavy Track	82-2372	82-2384				
<b>LUV</b>									
	LUV Pickup 2WD 4WD	73-81	eavy Track		80-2458				
<b>Niva</b>									
	Niva	02.05-11	eavy Track	Ⓞ 30-1703	Ⓞ 30-1704				
<b>Tahoe</b>									
	Tahoe, Yukon AWD	95-99	eavy Track	82-2372	82-2384				
<b>CHRYSLER AMERICA</b>									
<b>Crossfire</b>									
	Crossfire 3.2 V6	03-06	Sport Sport Kit	⌘Ⓞ 8041-1228Sport	⌘Ⓞ 8041-1229Sport	1140-7691	30	30	1,2,13,16
<b>Eagle Talon</b>									
	Eagle Talon 2WD Front: for K B struts only	90-94	Sport	⌘ⓄⓈ 8641-1231Sport					
	Eagle Talon 4WD Front: for K B struts only	90-94	Sport	⌘ⓄⓈ 8641-1231Sport					
	Eagle Talon 2WD	95-99	Sport	⌘Ⓞ 8041-1207Sport	⌘Ⓞ 8041-1208Sport				
	Eagle Talon 4WD	95-99	Sport	⌘Ⓞ 8041-1207Sport	⌘Ⓞ 8041-1208Sport				
<b>Sebring</b>									
	Sebring excl. Convertible	95-99	Sport	⌘Ⓞ 8041-1207Sport	Ⓝ⌘Ⓞ 8041-1208Sport				
<b>Voyager</b>									
	Voyager, Grand Voyager (Town & Country), excl. 4WD Front: for original struts only	03.95-07	Special	ⓄⓈ 8640-1428					
<b>CHRYSLER AUSTRALIA</b>									
<b>Valiant</b>									
	Valiant / Charger / Pacer / Ute and Wagon VE-VK and CL-CM models	62-81	Classic	⌘ 80-2311	⌘ 80-2163				
<b>CITROEN</b>									
<b>AX</b>									
	AX 1.0, 1.1, 1.4, GT and Diesel	86-96	STR.T Sport STR.T Kit Sport Kit	Ⓞ 8650-1003 86-2568Sport	Ⓞ 8050-1020 26-1481Sport	1120-9011 1140-9011	30-40 30-40	0 0	1,2,12,13 1,2,12,13
	AX 1.4 GTi	91-96	STR.T Sport STR.T Kit Sport Kit	Ⓞ 8650-1003 86-2568Sport	Ⓞ 8050-1020 26-1481Sport	1120-9011 1140-9011	30-40 30-40	0 0	1,2,12,13 1,2,12,13
	AX Sport	87-92	STR.T Sport STR.T Kit Sport Kit	Ⓞ 8650-1003 86-2568Sport	Ⓞ 8050-1020 26-1481Sport	1120-9011 1140-9011	30-40 30-40	0 0	1,2,12,13 1,2,12,13
<b>C1</b>									
	C1 1.0i, 1.4HDi	05-04.14	STR.T STR.T Kit	Ⓞ 8750-1090L 8750-1090R	Ⓞ 8050-1110	1120-1541	35 35		1,2,13
	C1 (B4)	05.14-19	STR.T STR.T Kit	Ⓞ 8750-1090L 8750-1090R	Ⓞ 8050-1110	1120-1541	35 35		1, 2, 13
<b>C2</b>									
	C2 VTR VTS: KONI Special is excluded	02.05-10	STR.T STR.T Kit	Ⓞ 8750-1013L 8750-1013R	Ⓞ 8050-1021	1120-3091	35 35		1,2,13
	C2 (China market) Dongfeng-Citroen	06-13	Sport	⌘ 8710-1372LSport 8710-1372RSport	Ⓞ 26-1653Sport				
<b>C3</b>									
	C3 excl. Pluriel and -TR	04.02-02.10	STR.T STR.T Kit	Ⓞ 8750-1013L 8750-1013R	Ⓞ 8050-1021	1120-3091	35 35		1,2,13
	C3 Pluriel	04.02-10	STR.T STR.T Kit	Ⓞ 8750-1013L 8750-1013R	Ⓞ 8050-1021	1120-3092	35 35		1,2,13
<b>C4</b>									
	C4 Hatchback / Coupé, incl. VTS	04-10	STR.T Sport STR.T Kit STR.T Kit	Ⓞ 8750-1018	Ⓞ 8250-1003 8240-1205Sport	1120-3472 1120-3471	35 35 35 35		1,2,13 1,2,13

MAKE		Year	product range				Lowering up to ..mm		Notes
Model							Front	Rear	
<b>CITROEN - CONTINUED</b>									
<b>DS3</b>									
	DS3 1.6 120 auto/THP155, 1.6 eHDI90 auto/eHDI110 Front: for original struts 51 mm only	09-17	Sport	8741-1555LSport 8741-1555RSport		8040-1413Sport			
<b>Saxo</b>									
	Saxo	04.96-04	STR.T	8650-1003		8050-1020			
	1.0, 1.1, 1.4, 1.5, 1.6 8V		Sport	86-2568Sport		26-1481Sport			
	1.6 16V		STR.T Kit				1120-7571	45	0
			Sport Kit				1140-7571	45	0
			STR.T Kit				1120-7861	30	0
			Sport Kit				1140-7861	30	0
<b>Traction Avant</b>									
	Traction 7 and 11 Tourisme TAV	37-56	Classic	80-1114		80-1196			
	Traction 15 Tourisme TAV	37-56	Classic	80-1196		80-1196			
<b>Xsara</b>									
	Xsara Hatchback / Coupé excl. 2.0 VTS, Break, D Suspension	97-04	STR.T	8750-1014L 8750-1014R		8050-1063			
			Sport	87-2601LSport 87-2601RSport		26-1486Sport			
			STR.T Kit				1120-5151	30	0
			Sport Kit				1140-5151	30	0
	Xsara 2.0 VTS excl. D suspension	98-04	STR.T	8750-1014L 8750-1014R		8050-1063			
			Sport	87-2601LSport 87-2601RSport		26-1486Sport			
			STR.T Kit				1120-5151	30	0
			Sport Kit				1140-5151	30	0
	Xsara Break	98-04	STR.T	8750-1014L 8750-1014R					
			Sport	87-2601LSport 87-2601RSport		26-1487Sport			
<b>ZX</b>									
	ZX 1.1, 1.4, 1.6, 1.8, 1.9D, 1.9TD Front: 1992: original struts without bracket for anti-roll bar	91-05-92	STR.T			8050-1063			
			Sport			26-1486Sport			
	ZX 1.9, 2.0, 2.0-16V up to chassiso. 5684	91-05-92	Sport			26-1487Sport			
	ZX 1.1, 1.4, 1.6, 1.8, 1.9D, 1.9TD Front: with anti-roll bar fitted to McPherson housing	06.92-97	STR.T	8750-1014L 8750-1014R		8050-1063			
			Sport	87-2601LSport 87-2601RSport		26-1486Sport			
	ZX 1.9, 2.0, 2.0-16V as from chassiso. 5685	06.92-97	STR.T	8750-1014L 8750-1014R					
			Sport	87-2601LSport 87-2601RSport		26-1487Sport			
	ZX Break	94-98	STR.T	8750-1014L 8750-1014R					
			Sport	87-2601LSport 87-2601RSport					
<b>DACIA</b>									
<b>Duster</b>									
	Duster 4x2	10-17	eavy Track	8740-1587L 8740-1587R		I.D.			
	Duster 4x4 Fit vehicles with standard or raised suspension, Front Rear: 0 - 30 mm	10-17	eavy Track	8740-1587L 8740-1587R		8740-1588			
	Duster II 4x2	01.18-	eavy Track	8740-1587L 8740-1587R					
	Duster II 4x4 Fit vehicles with standard or raised suspension, Front Rear: 0 - 30 mm	01.18-	eavy Track	8740-1587L 8740-1587R		8740-1588			
<b>DAEWOO (CHEVROLET)</b>									
<b>Espero</b>									
	Espero 1.5, 1.8, 2.0	95-99	STR.T	8650-1006		8050-1030			
<b>Lacetti Premiere</b>									
	Lacetti Premiere (Cruze)	08-16	Sport	8741-1568LSport 8741-1568RSport		8240-1293Sport			
<b>Lanos</b>									
	Lanos 1.3, 1.5, 1.6	97-03	STR.T	8650-1006		8050-1030			
<b>Nexia</b>									
	Nexia 1.5	95-99	STR.T	8650-1006		8050-1030			
<b>DAIHATSU</b>									
<b>Charmant</b>									
	Charmant 1600 EL Sedan (A45)	81-08.83	Sport			86-1991Sport			
	Charmant 1300/1450/1600 Sedan (A35 / A45 / A60)	09.83-88	Sport			86-1991Sport			
<b>DAIMLER</b>									
<b>2.5</b>									
	2.5 Liter V8	64-69	Classic	82-1019		82-1044			
<b>Double six</b>									
	Double six	64-69	Classic	82-1019					

MAKE	Model	Year	product range				Lowering up to ..mm		Notes
							Front	Rear	
<b>DAIMLER - CONTINUED</b>									
	Double six Rear: 4 pieces	72-02-93	Classic	☞☞ 26-1089	M0☞☞☞☞☞☞ 30-1090				
	Double six	10-94-98	Classic	☞☞ 26-1592	☞☞☞☞☞ 30-1593				
<b>Six</b>									
	Six Rear: 4 pieces	64-69	Classic	☞☞ 82-1019					
	Six 4.0	10-94-98	Classic		☞☞☞☞☞ 30-1593				
<b>Sovereign</b>									
	Sovereign	64-69	Classic	☞☞ 82-1019					
	Sovereign Rear: 4 pieces	70-86	Classic	☞☞ 26-1089	M0☞☞☞☞☞☞ 30-1090				
<b>DODGE</b>									
<b>Avenger</b>									
	Avenger Coupé	95-99	Sport	☞☞ 8041-1207Sport	☞☞ 8041-1208Sport				
<b>Caravan</b>									
	Caravan, Grand Caravan excl. AWD Front: for original struts only	96-04	Special	☞☞ 8640-1428					
<b>Challenger</b>									
	Challenger rear lower shock mount hole 5 8ths inch	70-74	Classic	☞☞ 80-1538	☞☞ 82-1255				
<b>Charger</b>									
	Charger, incl. Coronet (Super Bee) rear lower shock mount hole 5 8ths inch	65-72	Classic	☞☞ 80-1538	☞☞ 82-1255				
	Charger, incl. Coronet (Super Bee) rear lower shock mount hole 5 8ths inch	73-76	Classic		☞☞ 82-1255				
<b>D50</b>									
	D50 Pickup	79-85	heavy Track		80-2458				
<b>FERRARI</b>									
<b>308</b>									
	308 GTB, -GTS	75-85	Classic	☞☞☞ 82-1982SP6	☞☞☞ 82-1983SP6				
	Dino 308 GT4 (2+2) - F 106 AL 100 Rear: for availability contact www.koni.uk.com	73-80	Classic	☞☞☞ 82-1982SP6	☞☞☞ 82-1831SP1				
<b>365</b>									
	365 GT4 (2 + 2)	73-75	Classic		☞☞☞ 82-1825SP2				
	365 GT4 - BB Rear: 4 pieces	73-76	Classic	☞☞☞ 82-1833SP6	☞☞☞ 82-1984SP6				
<b>400</b>									
	400 GT, 400 Automatic	77-82	Classic		☞☞☞☞ 82-1825SP2				
<b>508</b>									
	508 E, CA, Coupe, 2+2	61-62	Classic	☞☞ 82-1216					on request
	508E63 Spyder Coupe 2+2	62-64	Classic	☞☞ 82-1216					on request
<b>512</b>									
	512 BB, 512 BBi Rear: 4 pieces	76-84	Classic	☞☞☞ 82-1833SP6	☞☞☞ 82-1984SP6				
<b>539</b>									
	539U63 & 62 Coupe Super America	62-64	Classic	☞☞ 82-1216					on request
	539U63 & 62 Berlinetta Lusso	62-64	Classic	☞☞ 82-1216					on request
<b>Dino</b>									
	Dino 206 GT, 246 GT, 246 GTS	69-74	Classic	☞☞☞ 82-1579SP2	☞☞☞ 82-1603SP2				
	Dino 308 GT4 (2+2)	73-80	Classic	☞☞☞ 82-1982SP6					
<b>FIAT</b>									
<b>124</b>									
	124, 124 S, incl. Coupé & Spider 2000	66-80	Sport	80-1877Sport	☞☞ 80-1878Sport				
	124 Spider incl. Abarth	03-16-	Sport	☞☞☞☞ 8241-1310Sport	☞☞☞☞ 8241-1311Sport				
	124 Spider incl. Abarth with these KONI Sport dampers icw the Fiat std. OEM Springs the car can be lowered approx. 30 mm (by means of clipped spring seat)	03-16-	Sport Kit	☞☞☞ 8241-1304Sport	☞☞☞ 8241-1305Sport	1140-9135-1	30	30	1,2,13,16
<b>131</b>									
	131 2000 Racing / Sport	78-81	Sport		☞☞ 80-1878Sport				
	131 Sedan (Mirafiori)	78-83	Sport		☞☞ 80-1878Sport				
<b>500</b>									
	500, 500 D, 500 Giardiniera	57-75	Classic	☞☞☞ 80-1308	☞☞☞ 80-1307				
	500 0.9, 1.2, 1.4, 1.3 Multijet & 1.4 Abarth Incl. Cabrio	07-19	Special-Active	☞☞ 8745-1247L ☞☞ 8745-1247R	☞☞ 8045-1248				
	Front axle load up to 770 kg		STR.T	☞☞ 8750-1127L ☞☞ 8750-1127R	☞☞ 8050-1146				
	Front axle load as from 771 kg		STR.T Kit						I.D.
	STR.T Kit								I.D.
<b>Barchetta</b>									
	Barchetta	95-07-05	STR.T		☞☞ 8250-1018				
<b>Bravo / Brava</b>									
	Bravo / Brava 1.2, 1.4, 1.6, 1.8, 1.9D/TD/JTD	96-01	STR.T	☞☞ 8750-1036	☞☞ 8250-1012				
	Bravo 2.0-20V HGT Front: excl. cars with Sport suspension	96-01	STR.T Kit			1120-6872	30	30	1,2,13
			STR.T		☞☞ 8250-1012				
<b>Coupé</b>									
	Coupé Front: for original Boge struts only	95-00	Sport	☞☞☞☞ 8641-1320Sport	☞☞ 8240-1149Sport				
	1.8 16V, 2.0 16V, 2.0 20V, 2.0 16V Turbo		Sport Kit			1140-9761	35	35	1,2,13,17

MAKE	Model	Year	product range				Lowering up to ..mm		Notes	
							Front	Rear		
<b>FIAT - CONTINUED</b>										
	2.0 20V Turbo		Sport Kit				1140-9762	35	35	1,2,13,17
<b>Ducato (250/290)</b>										
	<b>Ducato (250,290) Van, Box , Bus</b> Rear : Lmax 469 mm Lmin 307 mm	07.06-	Special-Active	8705-1332	8205-1006					
	Rear : Lmax 444 mm Lmin 295 mm		Special-Active		8205-1008					
	<b>Ducato (250, 290) Camper Van, Motorhome</b> Rear : Lmax 469 mm Lmin 307 mm	07.06-	Special-Active	8705-1332	8205-1006					
	Rear : Lmax 444 mm Lmin 295 mm		Special-Active		8205-1008					
	<b>Ducato based campers: Adria / Carthago / Hymer etc</b> With ALKO BTR5 rear axle, replacing OE: 1217058 Lmax 357 mm - Lmin 265 mm	07.06-	Special-Active	8705-1332	8805-1057					
	With ALKO BTR5 rear axle, replacing OE: 1217039 - Lmax 387 mm Lmin 295 mm		Special-Active		8805-1059					
	With ALKO BTR5 rear axle, replacing OE: 1217230 - Lmax 420 mm Lmin 318 mm		Special-Active		8805-1061					
<b>Fullback</b>										
	<b>Fullback (KV1T) 4WD</b> Fit vehicles with standard or raised suspension, Front Rear: 0 - 30 mm	15-19	heavy Track	Ⓒ 8240-1316	Ⓒ 8240-1318					
			T RAID	88-5396	90-5458					
<b>Grande Punto</b>										
	<b>Grande Punto (Evo)</b> excl. Sport Suspension	09.05-17	STR.T	Ⓒ 8750-1093L Ⓒ 8750-1093R	Ⓒ 8050-1111					
	Front axle load up to 850Kg		STR.T Kit			1120-1313	30	30	1,2,13	
	Front axle load as from 851 kg		STR.T Kit			1120-1314	30	30	1,2,13	
	with Sport Suspension		STR.T	Ⓒ 8750-1093L Ⓒ 8750-1093R	Ⓒ 8050-1113					
	Front axle load up to 850Kg		Sport		Ⓒ 8040-1399Sport					
	Front axle load as from 851 kg		STR.T Kit			1120-1311	30	30	1,2,13	
			STR.T Kit			1120-1312	30	30	1,2,13	
	<b>Grande Punto (Evo) 1.4 Abarth</b>	12.07-17	STR.T	Ⓒ 8750-1093L Ⓒ 8750-1093R	Ⓒ 8050-1113					
	Front axle load up to 850Kg		Sport		Ⓒ 8040-1399Sport					
	Front axle load as from 851 kg		STR.T Kit			1120-1311	30	30	1,2,13	
			STR.T Kit			1120-1312	30	30	1,2,13	
<b>Multipia</b>										
	<b>Multipia</b> Front: for original struts only	99-06	STR.T		Ⓒ 8250-1012					
<b>Panda</b>										
	<b>Panda 750, 1000 (Fire)</b>	86-03	Special		□ 80-2584					
	<b>Panda 1.1, 1.2, 1.3 Multijet, excl. 1.4 100hp</b> excl. 4 wheel drive	10.03-11	STR.T	Ⓒ 8750-1086L Ⓒ 8750-1086R	Ⓒ 8050-1106					
			Sport		Ⓒ ▲ 8040-1347Sport					
			STR.T Kit			1120-2401	30	30	1,2,13	
<b>Punto</b>										
	<b>Punto 55, 60, 75</b>	09.93-06.99	STR.T	Ⓒ 8750-1068	Ⓒ 8250-1018					
			STR.T Kit			1120-9521	40	40	1,2,13	
	<b>Punto 85, 90, 1.4 GT Turbo, 1.7TD</b>	09.93-06.99	STR.T	Ⓒ 8750-1068	Ⓒ 8250-1018					
			STR.T Kit			1120-9521	40	40	1,2,13	
	<b>Punto Cabrio</b>	09.93-06.99	STR.T	Ⓒ 8750-1068	Ⓒ 8250-1018					
	<b>Punto 1.1, 1.2, 1.4</b> excl. Grande Punto	07.99-10.09	STR.T	Ⓒ 8750-1076	Ⓒ 8050-1098					
			STR.T Kit			1120-4252	30	30	1,2,13	
	<b>Punto 1.2-16V Sporting-Speedgear</b> excl. Grande Punto	07.99-10.09	STR.T	Ⓒ 8750-1076	Ⓒ 8050-1098					
			STR.T Kit			1120-4252	30	30	1,2,13	
	<b>Punto 1.3 JTD, 1.9 D, 1.9 JTD</b> excl. Grande Punto	07.99-10.09	STR.T	Ⓒ 8750-1076	Ⓒ 8050-1098					
			STR.T Kit			1120-4251	30	30	1,2,13	
	<b>Punto 1.8 HGT / Abarth</b> excl. Grande Punto	07.99-10.09	STR.T	Ⓒ 8750-1076	Ⓒ 8050-1098					
<b>FORD AMERICA</b>										
<b>Bronco</b>										
	<b>Bronco</b> AWD	67-77	heavy Track	82-1518						
<b>Econoline</b>										
	<b>Econoline E250 / E350</b>	75-91	heavy Track	82-1518						
<b>F100</b>										
	<b>F100 - 1/2t Pickup</b> 2WD	65-69	heavy Track	82-1518						
	<b>F100 / F150 / F250 Pickup</b> 2WD	70-80	heavy Track	82-1518						
<b>F250</b>										
	<b>F250 - 3/4t Pickup</b> 2WD	65-69	heavy Track	82-1518						
	<b>F250 Crew Cab</b> 2WD	70-79	heavy Track	82-1518						
	<b>F350 - 1t Pickup</b> 2WD	67-69	heavy Track	82-1518						
	<b>F350 Super Cab</b> 2WD	74-79	heavy Track	82-1518						
<b>Fairmont</b>										
	<b>Fairmont Sedan, Futura Coupé, Squire Wagon</b>	78-80	Classic		Ⓒ 8040-1026					On request
	<b>Fairmont</b>	81-83	Classic		Ⓒ 8040-1026					On request

MAKE		Year	product range				Lowering up to ..mm		Notes
Model							Front	Rear	
<b>FORD AMERICA - CONTINUED</b>									
<b>Focus</b>									
	Focus Sedan / Hatchback, incl. SVT	99-04	Sport	☞☞▲ 8741-1400LSport ☞☞▲ 8741-1400RSport	☞☞ 8041-1286Sport				
	Focus Wagon	99-04	Sport	☞☞▲ 8741-1400LSport ☞☞▲ 8741-1400RSport					
<b>Mustang</b>									
	Mustang, incl. GT 350	64-70	Classic	☞ 82-1388SP3	☞ 82-1389				
	Mustang	71-73	Classic		☞ 82-1389				
	Mustang, excl. SVO Rear: with bushing length 36,5 mm	79-86	Classic		☞☞ 8040-1026				On request
	Rear: Quad shock		Classic		☞ 25-1215				
	Mustang SVO	84-84	Classic		☞☞ 8040-1026				On request
	Rear: Quad shock		Classic		☞ 25-1215				
	Mustang SVO	85-86	Classic	☞☞☞ 8741-1054	☞☞ 8040-1026				On request
	Rear: Quad shock		Classic		☞ 25-1215				
	Mustang V8, excl. Cobra R	87-93	Classic		☞☞ 8040-1026				On request
	Rear: Quad shock		Sport	☞☞ 8741-1121Sport	☞☞ 8041-1026Sport				On request
			Classic		☞ 25-1215				
	Mustang, excl. IRS	94-04	Sport	☞☞ 8741-1401Sport	☞☞ 8041-1186Sport				
	Rear: Quad shock		Classic		☞ 25-1215				
	double adjustable alternative		Sport		☞☞ 8042-1134Sport				On request
	Mustang with IRS	00-04	Sport	☞☞ 8741-1401Sport	☞☞ 8041-1270Sport				Rear: on request
	Rear: Quad shock		Classic		☞ 25-1215				
	Mustang 5th Gen. Coupé	04-03.10	Sport	☞☞ 8741-1494Sport	☞☞ 8241-1240Sport	1140-1721	45	45	1,2,13,16
	Mustang 5th Gen. Coupé	04.10-13	Sport	☞☞ 8741-1549Sport	☞☞ 8241-1240Sport	1140-1723	45	45	1,2,13,16
			Sport Kit						
	Mustang 5th Gen. Convertible	04-03.10	Sport	☞☞ 8741-1494Sport	☞☞ 8241-1240Sport	1140-1722	45	45	1,2,13,16
			Sport Kit						
	Mustang 5th Gen. Convertible	04.10-13	Sport	☞☞ 8741-1549Sport	☞☞ 8241-1240Sport	1140-1724	45	45	1,2,13,16
			Sport Kit						
	Mustang 5th Gen. Shelby GT500	04-03.10	Sport	☞☞ 8741-1494Sport	☞☞ 8241-1240Sport	1140-0631	30	40-45	1,2,13,16
			Sport Kit						
	Mustang 5th Gen. Shelby GT500	04.10-13	Sport	☞☞ 8741-1494Sport	☞☞ 8241-1240Sport	1140-0631	30	40-45	1,2,13,16
			Sport Kit						
	Mustang Coupé & Cabrio 4-cyl, V6, V8, Ecoboost excl. GT350, GT350R models with MagneRide	15-18	STR.T	☞ 8750-1112	☞ 8250-1039				
			Sport	☞☞ 8741-1589Sport	☞☞ 8241-1293Sport				
<b>Pinto</b>									
	Pinto Sedan, Runabout	70-80	Classic		☞ 80-2167				
<b>FORD AUSTRALIA</b>									
<b>Bronco</b>									
	Bronco (4WD) with front dampers behind the axle, excl. raised suspension	80-96	eavy Track		82-1969SP2	82-2138SP2			
	Bronco (4WD) with Quad suspension excl. extended suspension (front side)	80-96	eavy Track	☞ 80-2134		82-2138SP2			
	excl. extended suspension (rear side)		eavy Track		82-1969SP2				
<b>Cortina</b>									
	Cortina TE, TF Sedan and Wagon	77-84	Classic			☞ 80-2319			
<b>Falcon / Fairmont AU-series</b>									
	Falcon / Fairmont Sedan with solid rear axle	98-03.00	Classic			☞☞ 80-2513			
	with solid rear axle, lowered suspension (incl. standard R6 R8)		Sport	☞☞ 8241-1166Sport	☞☞☞ 8041-1067SP1				
			Classic		☞ 80-2513SP1				
			Sport	☞☞ 8241-1166Sport	☞☞ 8041-1067SP1				
	Falcon / Fairmont Station Wagon	98-09.02	Classic			☞ 80-2816			
			Sport	☞☞ 8241-1166Sport					
	Ute and 1 Toner	98-03.00	Sport	☞☞ 8241-1166Sport					
<b>Falcon / Fairmont X-Series</b>									
	Falcon GT, GTHO, Fairmont XR-XD Sedan with lowered suspension	66-82	Classic	☞ 82-1742SP4		☞ 80-2319			
	Falcon, Fairmont XR-XY Sedan, Wagon, Ute, Panel Van	66-72	Classic	☞ 82-1698		☞ 80-2111			
	Falcon, up to XD with lowered suspension	66-82	Classic	☞ 82-1742SP4		☞ 80-2319			
	Falcon, Fairmont XA-XD, XE-XF Wagon	72-87	Classic	☞ 82-1698		☞ 80-2319			
	Falcon, Fairlane ZA-ZJ Wagon, Ute and Panel Van	72-87	Classic	☞ 82-1698		☞ 80-2319			
	Falcon up to XG Van and Ute (incl. Longreach)	72-96	Classic	☞ 82-1698		☞ 80-2319			
	with lowered front suspension		Classic	☞ 82-1742SP4					
	Falcon, Fairlane ZK-ZL, Fairmont XE-XF Sedan LTD with Watts link rear suspension	82-87	Classic	☞ 82-1698		☞☞ 80-2513			
	Falcon XH Van and Ute	96-98	Classic	☞ 82-2432		☞ 80-2319			
			Sport	☞☞ 8241-1153Sport					
	Falcon Sedan, models XE and XF with lowered suspension	96-98	Classic	☞ 82-1742SP4		☞ 80-2513SP1			
<b>Falcon / Fairmont E-series</b>									
	Falcon models EA up to EL Sedan	88-98	Classic	☞ 82-2432		☞☞ 80-2513			
			Sport	☞☞ 8241-1153Sport	☞☞☞ 8041-1067Sport				
	with lowered suspension, incl. R6 and R8		Classic	☞ 82-2432		☞☞ 80-2513SP1			
			Sport	☞☞ 8241-1153Sport	☞☞☞ 8041-1067SP1				



MAKE		Year	product range				Lowering up to ..mm			Notes
Model	Front						Rear			
<b>FORD AUSTRALIA - CONTINUED</b>										
Falcon models EA up to EL Wagon	88-98	Classic	☞ 82-2432	☞ 80-2319						
		Sport	☞☞ 8241-1153Sport							
Fairmont Ghia models EA up to EL	88-98	Classic	☞ 82-2432	☞☞ 80-2513						
		Sport	☞☞ 8241-1153Sport	☞☞☞ 8041-1067Sport						
<b>Falcon BA-BF,Wagon,Series 2,3</b>										
Falcon BA XT, Futura, Fairmont, Ghia Sedan Incl. Series II	09.02-04.08	Classic	☞ 82-2535SP1	☞ 82-2536						
Falcon BA XR6 / XR8 Sedan Incl. Series II	09.02-04.08	Classic	☞ 82-2535SP1	☞ 82-2536						
Falcon BA XT, Futura, Fairmont, Wagon Incl. Series II	09.02-04.08	Classic	☞ 82-2535SP1	☞ 80-2816						
Falcon Ute (excl. lowered) Incl. Series II	09.02-04.08	Classic	☞ 82-2535SP1							
Falcon Ute (Lowered incl. standard XR6 / XR8) Incl. Series II	09.02-04.08	Classic	☞ 82-2535SP1	☞ 80-2816						
<b>Falcon / Fairmont FG - series</b>										
Falcon Sedan (All incl. XR6 / XR8)	05.08-	Classic	☞ 82-2582	☞ 82-2536						
Falcon Ute (Standard, excl. lowered)	05.08-	Classic	☞ 82-2582							
Falcon Ute (Lowered incl. standard XR6 / XR8)	05.08-	Classic	☞ 82-2582	☞ 80-2816						
<b>Fairlane / LTD</b>										
Fairmont Ghia EA, EB, ED, EF, EH, EL	88-98	Classic	☞ 82-2432	☞☞ 80-2513						
		Sport	☞☞ 8241-1153Sport	☞☞☞ 8041-1067Sport						
Fairlane NA, NC, NL DA and DC, DF Ltd.	88-98	Classic	☞ 82-2432	☞☞ 80-2513						
		Sport	☞☞ 8241-1153Sport	☞☞☞ 8041-1067Sport						
Fairmont EF, EL, LTD with self-levelling suspension	94-98	Classic	☞ 82-2432							
		Sport	☞☞ 8241-1153Sport							
<b>F-series</b>										
F100 / F250 / F350	74-80	heavy Track	82-1518							
F100 AWD	81-94	heavy Track	82-1969SP2							
F100 / F150	81-94	heavy Track	82-1969SP2	82-2138SP2						
F250 / F350	81-94	heavy Track	82-1969SP2	82-2138SP2						
F250 / F350 Super Duty 4x4	00-08	heavy Track	☐ 88-1719	☐ 88-1720						
Trailing		heavy Track		☐ 88-1721						
<b>Focus</b>										
Focus Hatchback / Sedan excl. ST R5 Turbo	06.05-11	Special-Active		☞ 8045-1068						
		STR.T	☞ 8750-1087L ☞ 8750-1087R	☞ 8050-1108						
		Sport	☞☞ 8741-1487LSport ☞☞ 8741-1487RSport	☞ 8040-1351Sport						
Focus ST & XR5 Turbo	06.05-11	Special-Active	☞ 8745-1110L ☞ 8745-1110R	☞ 8045-1096						
		STR.T	☞ 8750-1088L ☞ 8750-1088R	☞ 8050-1109						
		Sport	☞☞ 8741-1490LSport ☞☞ 8741-1490RSport	☞ 8040-1353Sport						
Focus Wagon excl. self-levelling systems	06.05-08	STR.T	☞ 8750-1087L ☞ 8750-1087R							
		Sport	☞☞ 8741-1487LSport ☞☞ 8741-1487RSport							
<b>Galaxie</b>										
Galaxie, LTD, Landau	73-82	Classic	☞ 82-1698	☞ 80-2319						
<b>Maverick</b>										
Maverick with standard springs only. Excl. Pickup	89-94	heavy Track	82-2347SP1	82-2348SP1						
		heavy Track	☞ 30-1379	☞ 30-1380						
with raised springs only. Excl. short wheel base models		heavy Track	82-2347	82-2348						
<b>Territory</b>										
Territory 2WD	06.04-06	heavy Track		☞ 82-2559						
Territory AWD	06.04-06	heavy Track		82-2559						
<b>FORD EUROPE</b>										
<b>Capri</b>										
Capri, Capri II and III, excl. 2.8i	73-85	Sport	86-1835Sport	☐ 80-2256Sport						
<b>Escort</b>										
Escort Mk1 RS 2000	75-75	Sport	86-1835Sport							
Escort Mk4 1.6i incl. Cabrio (GAF) (Car will be lowered by approx. 15 mm)	86-08.90	Sport		☞☞▲ 8741-1119Sport						
Escort Mk4 RS Turbo	86-08.90	Sport		☞☞▲ 8741-1119Sport						
Escort Mk4 XR3i (Car will be lowered by approx. 15 mm)	86-08.90	Sport		☞☞▲ 8741-1119Sport						
Escort Mk5 2.0i Turbo-16V Cosworth (4WD)	92-94	Sport		☞ 26-1294Sport						
<b>Fiesta</b>										
Fiesta V	04.02-08	STR.T	☞ 8750-1081L ☞ 8750-1081R	☞ 8050-1103						
Sport, ST150		STR.T Kit			1120-3172	25-30	25-30	1,2,13		
Fiesta VI	08-10.12	Sport	☞☞ 8741-1565LSport ☞☞ 8741-1565RSport	☞ 8040-1419Sport						
		Sport Kit			1140-0121	35	35	1, 2, 13, 17		
Fiesta VI Facelift	11.12-12.16	Sport	I.D.	☞ 8040-1419Sport						

MAKE		Year	product range				Lowering up to ..mm		Notes			
Model							Front	Rear				
<b>FORD EUROPE - CONTINUED</b>												
Fiesta VI ST / ST200		03.13-	Sport		I.D.	I.D.						
<b>Focus</b>												
Focus I Sedan/Hatchb., 1.4, 1.6, 1.8, 2.0 & Diesel excl. Wagon. 1.8 TDCi: KONI STR.T only		98-11.04	STR.T	Ⓞ▲ 8750-1025L Ⓞ▲ 8750-1025R		Ⓞ 8050-1032						
			Sport	Ⓞ▲ 8741-1400LSport Ⓞ▲ 8741-1400RSport								
			STR.T Kit				1120-4651	35	35	1,2,13		
Focus I ST170		02-05	STR.T	Ⓞ▲ 8750-1025L Ⓞ▲ 8750-1025R		Ⓞ 8050-1032						
			Sport	Ⓞ▲ 8741-1400LSport Ⓞ▲ 8741-1400RSport								
			STR.T Kit				1120-4651	35	35	1,2,13		
Focus II Hatchback / Sedan, excl. ST		11.04-11	Special-Active			Ⓞ 8045-1068						
			STR.T	Ⓞ 8750-1087L Ⓞ 8750-1087R		Ⓞ 8050-1108						
			Sport	Ⓞ▲ 8741-1487LSport Ⓞ▲ 8741-1487RSport		Ⓞ 8040-1351Sport						
			STR.T Kit				1120-1821	40	40	1,2,7,13		
			Sport Kit				1140-1821	40	40	1,2,7,13,17		
Front axle load up to 990 kg			STR.T Kit						1120-1822	40	40	1,2,7,13
Front axle load as from 991 kg			Sport Kit						1140-1822	40	40	1,2,7,13,17
Focus II ST 2.5		10.05-11	Special-Active	Ⓞ 8745-1110L Ⓞ 8745-1110R		Ⓞ 8045-1096						
			STR.T	Ⓞ 8750-1088L Ⓞ 8750-1088R		Ⓞ 8050-1109						
			Sport	Ⓞ▲ 8741-1490LSport Ⓞ▲ 8741-1490RSport		Ⓞ 8040-1353Sport						
			STR.T Kit				1120-1827	25	25	1,2,13		
			Sport Kit				1140-1827	25	25	1,2,13,17		
Focus II Wagon excl. self-levelling systems		11.04-11	STR.T	Ⓞ 8750-1087L Ⓞ 8750-1087R								
			Sport	Ⓞ▲ 8741-1487LSport Ⓞ▲ 8741-1487RSport								
Focus II RS		09-13	Sport	Ⓞ▲ 8741-1551LSport Ⓞ▲ 8741-1551RSport		Ⓞ▲ 8041-1409Sport						
			Sport Kit				1140-9831	30	30	1,2,13,16		
Focus C-Max MPV		10.03-11.10	Special-Active	Ⓞ 8745-1110L Ⓞ 8745-1110R		Ⓞ 8045-1096						
			STR.T	Ⓞ 8750-1088L Ⓞ 8750-1088R		Ⓞ 8050-1109						
			Sport	Ⓞ▲ 8741-1490LSport Ⓞ▲ 8741-1490RSport		Ⓞ 8040-1353Sport						
			STR.T Kit				1120-2291	35	35	1,2,13		
			Sport Kit				1140-2291	35	35	1,2,13,17		
Front axle load up to 990 kg			STR.T Kit						1120-2292	35	35	1,2,13
Front axle load as from 991 kg			Sport Kit						1140-2292	35	35	1,2,13,17
Coupé-Cabriolet 1.6-16V, 2.0-16V, 2.0TDCi		07-10	Special-Active	Ⓞ 8745-1110L Ⓞ 8745-1110R								
			STR.T	Ⓞ 8750-1088L Ⓞ 8750-1088R								
			Sport	Ⓞ▲ 8741-1490LSport Ⓞ▲ 8741-1490RSport		Ⓞ 8040-1405Sport						
			STR.T Kit				1140-1825	35	35	1,2,13,17		
			Sport Kit				1140-1826	35	35	1,2,13,17		
Front axle load up to 990 kg			Sport Kit						1140-9273	35	35	1, 2, 3, 17
Front axle load as from 991 kg			Sport Kit						1140-9274	35	35	1, 2, 3, 17
Focus III Hatchback / Sedan excl. ST		11-12.14	Special-Active			Ⓞ 8045-1068						
			Sport	Ⓞ▲ 8741-1557LSport Ⓞ▲ 8741-1557RSport		Ⓞ 8040-1351Sport						
Front axle load up to 1030 kg			Sport Kit						1140-9273	35	35	1, 2, 3, 17
Front axle load as from 1031 kg			Sport Kit						1140-9274	35	35	1, 2, 3, 17
Focus III Hatchback / Sedan		15-18	Special-Active			Ⓞ 8045-1068						
			Sport		I.D.	Ⓞ 8040-1351Sport						
Focus III Wagon		11-12.14	Sport	Ⓞ▲ 8741-1557LSport Ⓞ▲ 8741-1557RSport								
			Sport Kit						I.D.			
<b>Ka</b>												
Ka II 1.2 , 1.3TDCi		08-12.15	Special-Active	Ⓞ 8745-1247L Ⓞ 8745-1247R		Ⓞ 8045-1248						
			STR.T	Ⓞ 8750-1127L Ⓞ 8750-1127R		Ⓞ 8050-1146						
			STR.T Kit							I.D.		
<b>Maverick</b>												
Maverick 2-door (s.w.) AWD		93-00	eavy Track	Ⓞ 30-1365		Ⓞ 30-1372						
Maverick 4-door (l.w.) AWD		93-00	eavy Track	Ⓞ 30-1588		Ⓞ 30-1372						

MAKE	Model	Year	product range				Lowering up to ..mm		Notes	
							Front	Rear		
<b>FORD EUROPE - CONTINUED</b>										
<b>Mondeo</b>										
	Mondeo III Sedan / Hatchback (excl. ST220)	11.00-07	STR.T	Ⓒ 8750-1079		Ⓒ 8750-1080				
	For Petrol engines only		Sport	ⓂⒸ 8741-1441Sport			1120-3651	35	35	1,2,13
	For Diesel engines only		STR.T Kit				1120-3653	35	35	1,2,13
	Mondeo III Wagon 4-cyl. excl. Diesel excl. self-levelling systems	09.00-07	STR.T	Ⓒ 8750-1079						
			Sport	ⓂⒸ 8741-1441Sport						
	Mondeo III Wagon 6-cyl. (excl. ST220) & D excl. self-levelling systems	09.00-07	STR.T	Ⓒ 8750-1079						
			Sport	ⓂⒸ 8741-1441Sport						
	Mondeo IV Sedan, Hatchb. incl Sport Pack & S-Pack excl. CCD (Continuously Controlled Damping)	03.07-14	Special-Active			ⒺⒸ 8245-1256				
			Sport	ⓂⒸ 8741-1536LSport		ⒺⒸ 8240-1268Sport				
			Sport Kit	ⓂⒸ 8741-1536RSport			1140-0651	40	40	1,2,13,15,17
	Front axle load up to 1100 kg		Sport Kit				1140-0652	40	40	1,2,13,15,17
	Mondeo IV Wagon incl Sport Pack & S-Pack excl. CCD (Continuously Controlled Damping)	03.07-14	Special-Active			ⒺⒸ 8245-1256				
			Sport	ⓂⒸ 8741-1536LSport		ⒺⒸ 8240-1268Sport				
			Sport Kit	ⓂⒸ 8741-1536RSport			1140-0653	40	40	1,2,13,15,17
	Front axle load up to 1100 kg		Sport Kit				1140-0654	40	40	1,2,13,15,17
	Front axle load as from 1101 kg		Sport Kit							
	Mondeo V Sedan/Hatchback/Wagon excl. self-levelling systems	15-19	STR.T	Ⓒ 8750-1113L Ⓒ 8750-1113R		ⒺⒸ 8250-1043				
<b>Mustang</b>										
	Mustang Coupé & Cabrio 4-cyl, V6, V8, Ecoboost excl. GT350, GT350R models with MagneRide	15-09-18	STR.T	Ⓒ 8750-1112		Ⓒ 8250-1039				
			Sport	ⓂⒸ 8741-1589Sport		ⓂⒸ 8241-1293Sport				
			STR.T Kit				1120-8779-1	25	25	1, 2, 13
			Sport Kit				1140-8779-1	25	25	1, 2, 13, 16
<b>Orion</b>										
	Orion 1.6i, 1.6i Ghia	84-08-90	Sport			ⓂⒸ▲ 8741-1119Sport				
<b>Ranger</b>										
	Ranger (T6) 4x2 Low	11-19	eavy Track	82-2601		82-2602				
	Ranger (T6) 4x2 Hi-Rider & 4x4 Fit vehicles with standard or raised suspension, Front Rear: 0 - 30 mm	11-19	eavy Track	82-2603SP1		82-2604				
			T RAID	88-1817		90-5474				
<b>Sierra</b>										
	Sierra Hatchback / Sedan	06.84-92	Sport	ⓂⒸ▲ 8741-1074Sport						
	Sierra XR4i	06.84-85	Sport	ⓂⒸ▲ 8741-1074Sport						
	Sierra XR 4WD	85-92	Sport	ⓂⒸ 8741-1109Sport		Ⓒ 26-1294Sport				
	Sierra RS Cosworth	86-86	Sport	ⓂⒸ 8741-1124Sport		Ⓒ 26-1294Sport				
	Sierra Cosworth Sedan	87-89	Sport	ⓂⒸ 8741-1124Sport		Ⓒ 26-1294Sport				
	Sierra Cosworth Sedan AWD	90-92	Sport	ⓂⒸ 8741-1109Sport		Ⓒ 26-1294Sport				
<b>HOLDEN (AUSTRALIA)</b>										
<b>Astra</b>										
	Astra TR excl. GSi	91-98	Sport			Ⓜ 8010-1032Sport				
	Astra TR GSi	91-98	Sport	Ⓜ 8610-1283Sport		Ⓜ 8010-1032Sport				
	Astra TS Sedan / Hatchback / Coupé / Cabrio GSi, Sport and OPC: KONI Special is excluded	98-07-04	Sport	Ⓜ▲ 8710-1369LSport		80-2796Sport				
				Ⓜ▲ 8710-1369RSport						
<b>Barina</b>										
	Barina MF, MH Front: for K. B and Showa only	89-93	Sport	◆ 86-2588Sport		□ 87-2429Sport				
	Barina SB excl. GSi	94-00	Sport	Ⓜ 8710-1276Sport						
	Barina SB Combo	95-98	Sport	Ⓜ 8710-1276Sport						
	Barina SB GSi	94-00	Sport	Ⓜ 8710-1276Sport						
	Barina XC	02.01-11.05	STR.T	Ⓒ 8750-1034L Ⓒ 8750-1034R		Ⓒ 8050-1054				
<b>Calibra</b>										
	Calibra YE Coupé incl. 4WD	90-96	Sport	Ⓜ 8610-1263Sport		Ⓜ 8210-1158Sport				
<b>Commodore</b>										
	Commodore VB - VP Sedan only for D suspension, with short rear dampers	78-93	Classic	Ⓜ 86-2076SP1						
			Classic			Ⓜ 80-2597				
			Sport	ⓂⒸ 8641-1066Sport		ⓂⒸ 8041-1094Sport				
	Commodore VP Sedan with IRS (independant rear suspension)	92-93	Classic	Ⓜ 86-2076SP1		Ⓜ 80-2738				
			Sport	ⓂⒸ 8641-1066Sport		ⓂⒸ 8041-1194Sport				
	Commodore VB - VP Station Wagon	78-93	Classic	Ⓜ 86-2076SP1		Ⓜ 80-2233SP1				
			Sport	ⓂⒸ 8641-1066Sport						
	Commodore VG Ute, Maloo for light duty only	91-93	Classic	Ⓜ 86-2076SP1		Ⓜ 80-2233SP1				
			Sport	ⓂⒸ 8641-1066Sport						
	Statesman, Caprice VQ Front: for original struts only. With IRS	90-94	Classic	Ⓜ 86-2076SP1		Ⓜ 80-2738				
			Sport	ⓂⒸ 8641-1066Sport		ⓂⒸ 8041-1194Sport				
	Commodore VR, VS Sedan V6 and V8 Front: for original struts only, Rear: with solid axle	93-07-97	Classic	Ⓜ◆ 86-2535						
			Sport	ⓂⒸ◆ 8641-1297Sport		ⓂⒸ 8041-1094Sport				
	Front: for original struts only, Rear: with solid axle and low-ered FE2 D suspension		Classic	Ⓜ◆ 86-2535		Ⓜ 80-2597				
			Sport	ⓂⒸ◆ 8641-1297Sport		ⓂⒸ 8041-1094Sport				
	Front: for original struts only, Rear: with IRS, excl. lowered suspension		Classic	Ⓜ◆ 86-2535		Ⓜ 80-2738				
			Sport	ⓂⒸ◆ 8641-1297Sport		ⓂⒸ 8041-1194Sport				

MAKE	Model	Year	product range				Lowering up to ..mm		Notes
							Front	Rear	
<b>HOLDEN (AUSTRALIA) - CONTINUED</b>									
Commodore VR, VS Station Wagon V6 and V8 Front: for original struts only	93-07-97	Classic	⌘◆ 86-2535	⌘ 80-2233SP1					
			⌘Ⓞ◆ 8641-1297Sport						
Commodore VR, VS Ute V6 and V8 Front: for original struts only, for light duty only	93-07-97	Classic	⌘◆ 86-2535	⌘ 80-2233SP1					
			⌘Ⓞ◆ 8641-1297Sport						
Statesman, Caprice VR, VS Front: for original struts only, SV + olden Sports models: use Sport dampers Front: for original struts only, for lowered vehicles only	93-07-98	Classic	⌘◆ 86-2535	⌘ 80-2738					
			⌘Ⓞ◆ 8641-1297Sport	⌘Ⓞ 8041-1194Sport					
			⌘◆ 8610-1439Sport					Lmax -30 mm	
Commodore VT - VZ Sedan Front: for original struts only, SV + olden Sports models: use Sport dampers Front: for original struts only, for lowered vehicles only	08.97-07.06	Classic	⌘◆ 86-2535	⌘ 80-2738					
			⌘Ⓞ◆ 8641-1297Sport	⌘Ⓞ 8041-1194Sport					
			⌘◆ 8610-1439Sport					Lmax -30 mm	
Commodore VT - VZ Station Wagon & Ute Front: for original struts only, Rear: with IRS (independent rear suspension) Front: for original struts only, Rear: with IRS, for lowered vehicles only	08.97-07.06	Classic	⌘◆ 86-2535	⌘ 80-2792SP1					
			⌘Ⓞ◆ 8641-1297Sport						
			⌘◆ 8610-1439Sport					Lmax -30 mm	
Commodore VE / VF Sedan incl. Berlina, Calais and SV Clubsport R8, excl. SV GTS	07.06-17	Special-Active			2100-4074				only in Australia
		Sport	⌘Ⓞ◆ 8641-1506Sport	82-2567Sport					
Commodore VE / VF Station Wagon	04.08-17	Sport	⌘Ⓞ◆ 8641-1506Sport						
Commodore VE / VF Ute incl. SV Maloo	10.07-17	Sport	⌘Ⓞ◆ 8641-1506Sport						
<b>Crewman</b>									
Crewman VZ Front: for original struts only	02.04-07.06	Classic	⌘◆ 86-2535						
			⌘Ⓞ◆ 8641-1297Sport						
Crewman VZ Cross 6 & 8 Front: for original struts only	12.03-07.06	Sport	⌘Ⓞ◆ 8641-1506Sport						
<b>Cruze</b>									
Cruze	08-16	Sport	⌘Ⓞ 8741-1568LSport ⌘Ⓞ 8741-1568RSport	Ⓞ 8240-1293Sport					
<b>E-, F- and H-series</b>									
Series FJ - FB, EK - EH, HD - HG Standard, Special, Business, Premier, Belmont, Brougham, Kingswood, Monaro, Panel Van and Ute	53-71	Classic	⌘ 80-2133	⌘ 80-2134					
Series HQ - HZ Sedan, Wagon Belmont, Kingswood, Monaro, Premier, incl. GTS, LE and SS	71-80	Classic	⌘ 80-2156SP1	⌘ 80-2157SP1					
Series HQ - HZ Panel Van, Ute and Pick-Up 1 Tonne, Belmont, Kingswood and Sandman	71-85	Classic	⌘ 80-2156SP1	⌘ 80-2320					
<b>Frontera</b>									
Frontera M7	95-97	eavy Track	Ⓞ 30-1565	Ⓞ 30-1566					
Frontera MX ES SE Models	10.98-00	eavy Track	Ⓞ 30-1663	Ⓞ 30-1664					
<b>Gemini</b>									
Gemini TX, TC, TD, TE, TF, TG Sedan / Coupé	75-85	Classic	⌘□ 80-2275						
			□ 82-1886Sport						
Gemini TD, TE, TF, TG Station Wagon / Panel Van	78-85	Classic	⌘□ 80-2275	⌘ 80-2134					
<b>Jackaroo</b>									
Jackaroo UBS 13, 16, 52 (4WD) high pressure gas alternative	82-86	eavy Track	Ⓞ 30-1326						
Jackaroo UBS 16, 17, 52, 55 (4WD) excl. raised suspension	87-91	eavy Track	Ⓞ 30-1365						
Jackaroo UBS 25, 69 excl. raised suspension	92-01.98	eavy Track	Ⓞ 30-1565	Ⓞ 30-1566					
Jackaroo UBS 59, 73 excl. raised suspension	97-00	eavy Track	Ⓞ 30-1565	Ⓞ 30-1566					
<b>Piazza</b>									
Piazza YB	04.86-90	Classic	⌘□ 80-2275	⌘ 80-2233SP1					
			□ 82-1886Sport						
<b>Rodeo</b>									
Rodeo KB 26 (2WD) excl. raised suspension	86-89	eavy Track		80-1904					
Rodeo KB 46 (4WD) excl. raised suspension	86-89	eavy Track		80-1904					
Rodeo TF (4WD) Rear: with PIN E E attachment	08.88-98	eavy Track	Ⓞ 30-1365						
Rodeo (4WD)	02.98-00	eavy Track	Ⓞ 30-1565	Ⓞ 30-1664					
Rodeo RA (4WD) with torsion bars front	03-08	eavy Track	▲ 82-2454	82-2138					
<b>Statesman</b>									
Statesman, Caprice, de Ville	71-85	Classic	⌘ 80-2156SP1	⌘ 80-2157SP1					
Statesman, Caprice VQ	90-93	Classic	⌘ 86-2076SP1	⌘ 80-2738					
			⌘Ⓞ 8641-1066Sport	⌘Ⓞ 8041-1194Sport					
Statesman, Caprice VR, VS, WH, WK, WL	93-06	Classic	⌘◆ 86-2535	⌘ 80-2738					
			⌘Ⓞ◆ 8641-1297Sport	⌘Ⓞ 8041-1194Sport					
Statesman, Caprice WM excl. MRC (as fitted to SV GTS, Senator, Grange)	06-13	Sport	⌘Ⓞ◆ 8641-1506Sport	82-2567Sport					
<b>Torana</b>									
Torana LC, LJ (6-cyl.) incl. GTR, XU1	69-74	Classic	⌘ 80-2153	⌘ 80-2134					
Torana LH, LX, UC (6/8-cyl.) and Sunbird	74-80	Classic	⌘ 80-2156SP1	⌘ 80-2299					
<b>Vectra</b>									
Vectra New Zealand only	94-95	Sport	⌘ 8610-1263Sport	⌘Ⓞ 8041-1095Sport					

MAKE	Model	Year	product range				Lowering up to ..mm		Notes	
							Front	Rear		
<b>HOLDEN (AUSTRALIA) - CONTINUED</b>										
	<b>Vectra JR, JS</b> Fully imported models	96-02	Special-Active			ⓈⓈ 8045-1160				
	<b>Vectra ZC Sedan / Wagon</b> excl. OPC, IDS-Plus and self-levelling systems, GTS and Wagon: use Sport only	03-12.06	Sport			ⓈⓈ 8040-1334Sport				
<b>GMC</b>										
<b>C-1500 / C-2500</b>										
	<b>C-1500 / C-2500 Pickup</b> Rear: Lmax. 680 mm	73-86	heavy Track			82-2384				
<b>K-1500 / K-2500</b>										
	<b>K-1500 / K-2500 / K-3500 Pickup (4WD)</b>	87-98	heavy Track		82-2372	82-2384				
	<b>K-1500 / K-2500 Suburban (4WD)</b>	92-97	heavy Track		82-2372					
<b>Yukon</b>										
	<b>Yukon (4WD)</b>	95-99	heavy Track		82-2372	82-2384				
<b>HONDA</b>										
<b>Accord</b>										
	<b>Accord Aerodeck 2.2 (CB8)</b> with these KONI Sport dampers the car can be lowered approx. 15 mm	90-92	Sport	N3ⓈⓈⓈ 8041-1185LSport N3ⓈⓈⓈ 8041-1185RSport		R6+R7ⓈⓈⓈ 8041-1168SP4				
	<b>Accord Sedan 1.8, 2.0, 2.0i, 2.2i (CB)</b> with these KONI Sport dampers the car can be lowered approx. 15 mm	90-92	Sport	N3ⓈⓈⓈ 8041-1185LSport N3ⓈⓈⓈ 8041-1185RSport		R6+R7ⓈⓈⓈ 8041-1168SP4				
	<b>Accord Sedan 2.0, 2.2, incl. Diesel</b> with these KONI Sport dampers the car can be lowered approx. 15 mm	93-98	Sport	N3ⓈⓈⓈ 8041-1185LSport N3ⓈⓈⓈ 8041-1185RSport		R6+R7ⓈⓈⓈ 8041-1168SP4				
	<b>Accord Aerodeck 2.0, 2.2 (CE1 / CE2)</b> with these KONI Sport dampers the car can be lowered approx. 15 mm	04.94-98	Sport	N3ⓈⓈⓈ 8041-1185LSport N3ⓈⓈⓈ 8041-1185RSport		R6+R7ⓈⓈⓈ 8041-1168SP4				
	<b>Accord Coupé 2.0, 2.2 (CD7 / CD9)</b> with these KONI Sport dampers the car can be lowered approx. 15 mm	94-98	Sport	N3ⓈⓈⓈ 8041-1185LSport N3ⓈⓈⓈ 8041-1185RSport		R6+R7ⓈⓈⓈ 8041-1168SP4				
	<b>Accord Sedan / Coupé (US market versions only)</b>	98-02	Sport	N3ⓈⓈⓈ 8041-1257Sport		N5ⓈⓈⓈ 8041-1258Sport				
	<b>Accord Coupé (CG2)</b>	98-02	Sport	N3ⓈⓈⓈ 8041-1257Sport		N5ⓈⓈⓈ 8041-1258Sport				
	<b>Accord Sedan 2.0, 2.2CTDi, 2.4, 3.0 V6</b> excl. Accord Type R 2.0-16V 220 p	03-08	Sport	N3ⓈⓈⓈ 8041-1322LSport N3ⓈⓈⓈ 8041-1322RSport		M3+N3ⓈⓈⓈ 8041-1329Sport				
	2.0, 2.4, 3.0 V6		Sport Kit				1140-2811	35	35	1,2,13,16
	2.2 CDTi		Sport Kit				1140-2813	35	35	1,2,13,16
	<b>Accord Tourer 2.0, 2.2CTDi, 2.4, 3.0 V6</b> excl. Accord Type R 2.0-16V 220 p	03-08	Sport	N3ⓈⓈⓈ 8041-1322LSport N3ⓈⓈⓈ 8041-1322RSport						
	<b>Accord Sedan, 2.0i, 2.4i, 2.2i-DTEC</b>	08-14	Sport	N3ⓈⓈⓈ 8041-1406LSport N3ⓈⓈⓈ 8041-1406RSport		N3ⓈⓈⓈ 8041-1407Sport				
	Front axle load up to 1045 kg		Sport Kit				1140-0231	35	35	1,2,13,16
	Front axle load as from 1046 kg		Sport Kit				1140-0232	35	35	1,2,13,16
	<b>Accord Tourer, 2.0i, 2.4i, 2.2i-DTEC</b>	08-14	Sport	N3ⓈⓈⓈ 8041-1406LSport N3ⓈⓈⓈ 8041-1406RSport		N3ⓈⓈⓈ 8041-1407Sport				
	Front axle load up to 1045 kg		Sport Kit				1140-0233	35	35	1,2,13,16
	Front axle load as from 1046 kg		Sport Kit				1140-0234	35	35	1,2,13,16
<b>Civic</b>										
	<b>Civic Sedan/Hatchback/Coupé (EC/ED/EE)</b>	89-91	Sport	ⓈⓈⓈ 8041-1166SP4						
	<b>CRX Coupé (EG2 - EH6)</b>	07.92-00	STR.T	Ⓢ 8050-1011		Ⓢ 8050-1012				
			Sport	N6ⓈⓈⓈ 8041-1152Sport		R4ⓈⓈⓈ 8041-1153Sport				
			STR.T Kit				1120-8631	30	30	1,2,13
			Sport Kit				1140-8631	30	30	1,2,13,16
			Coil-over Kit				1150-5006-1	60	60	2,13,16,21,22,26
	for non-European cars with an eye-attachment on the rear damper (instead of a -bracket)		STR.T	Ⓢ 8050-1011						
			Sport	N6ⓈⓈⓈ 8041-1152Sport		R4ⓈⓈⓈ 8041-1164Sport				
	<b>CRX Coupé incl. VTEC and VTi</b>	07.95-00	STR.T	Ⓢ 8050-1011		Ⓢ 8050-1016				
			Sport	N6ⓈⓈⓈ 8041-1152Sport		R4ⓈⓈⓈ 8041-1213Sport				
			STR.T Kit				1120-7361	35	35	1,2,13
			Sport Kit				1140-7361	35	35	1,2,13,16
	<b>Civic Sedan / Hatchback</b>	92-95	STR.T	Ⓢ 8050-1011		Ⓢ 8050-1012				While stocks last
			Sport	N6ⓈⓈⓈ 8041-1152Sport		R4ⓈⓈⓈ 8041-1153Sport				
			Sport Kit				1140-8631	30	30	1,2,13,16
			Coil-over Kit				1150-5006-1	60	60	13,16,21,22,26
	for non-European cars with an eye-attachment on the rear damper (instead of a -bracket)		STR.T	Ⓢ 8050-1011						
			Sport	N6ⓈⓈⓈ 8041-1152Sport		R4ⓈⓈⓈ 8041-1164Sport				
			Sport Kit				1140-8632	30	30	1,2,13,16
	<b>Civic Coupé 1.5 (EG / EH) USA-Versions</b>	93-95	STR.T	Ⓢ 8050-1011		Ⓢ 8050-1012				
			Sport	N6ⓈⓈⓈ 8041-1152Sport		R4ⓈⓈⓈ 8041-1153Sport				
			Coil-over Kit				1150-5006-1	60	60	16,21,22,26
	<b>Civic Sedan / Hatchback / Coupé (EJ / EK)</b>	07.95-00	STR.T	Ⓢ 8050-1011		Ⓢ 8050-1016				
			Sport	N6ⓈⓈⓈ 8041-1152Sport		R4ⓈⓈⓈ 8041-1213Sport				
			STR.T Kit				1120-7361	35	35	1,2,13
			Sport Kit				1140-7361	35	35	1,2,13,16
	<b>Civic Hatchback (EU5/6/7/8/9, EP1/2)</b> Front: for original struts 50 mm only	00-05	Sport	ⓈⓈⓈ ◆ 8641-1416Sport		M2ⓈⓈⓈ 8041-1281Sport				
	E 5 6 7 8, EP1 2		Sport Kit				1140-3591	35	35	1,2,13,16
	E 9		Sport Kit				1140-3592	35	35	1,2,13,16
	Front: for original struts 55 mm only		Sport	ⓈⓈⓈ ◆ 8610-1415Sport		M2ⓈⓈⓈ 8041-1281Sport				

MAKE		Year	product range				Lowering up to ..mm		Notes
Model	Year						Front	Rear	
<b>HONDA - CONTINUED</b>									
E 5 6 7 8, EP1 2			Sport Kit			1140-3593	35	35	1,2,13,16
E 9			Sport Kit			1140-3594	35	35	1,2,13,16
<b>Civic Hatchback (EP3) Type R</b> Front: for original struts 55 mm only	01-05		Sport	Ⓜ◆ 8610-1415Sport	Ⓜ 8010-1050Sport				
			Sport Kit			1140-3321	30	30	1,2,13,16
<b>Civic Hatchback (EP4)</b> Front: for original struts 50 mm only	00-05		Sport	ⓂⓄ◆ 8641-1416Sport	M2ⓄⓂⓂⓂⓄ 8041-1281Sport				
Front: for original struts 55 mm only			Sport Kit			1140-3592	35	35	1,2,13,16
			Sport	Ⓜ◆ 8610-1415Sport	M2ⓄⓂⓂⓂⓄ 8041-1281Sport				
			Sport Kit			1140-3594	35	35	1,2,13,16
<b>Civic Sedan (ES4/5/6/7)</b> Front: for original struts 50 mm only	01-05		Sport	ⓂⓄ◆ 8641-1416Sport	M2ⓄⓂⓂⓂⓄ 8041-1281Sport				
			Sport Kit			1140-3591	35	35	1,2,13,16
<b>Civic Coupé (EM2)</b> Front: for original struts 50 mm only	01-05		Sport	ⓂⓄ◆ 8641-1416Sport	M2ⓄⓂⓂⓂⓄ 8041-1281Sport				
Front: for original struts 55 mm only			Sport Kit			1140-3591	35	35	1,2,13,16
			Sport	Ⓜ◆ 8610-1415Sport	M2ⓄⓂⓂⓂⓄ 8041-1281Sport				
			Sport Kit			1140-3593	35	35	1,2,13,16
<b>Civic Europe (FN, FK) 1.4i, 1.8i, 2.2CDi excl. 'R'</b> Front: for original struts only	06-12		Sport	ⓂⓄ◆ 8641-1498Sport	ⓂⓄ 8041-1361Sport				
Front axle load up to 940 kg			Sport Kit			1140-1301	30	30	1,2,13,16
Front axle load as from 941 kg			Sport Kit			1140-1302	30	30	1,2,13,16
<b>Civic Asia (FD) 1.4i, 1.8i, 2.2CDi excl. 'R'</b> Front: for original struts only	06-12		Sport	ⓂⓄ◆ 8641-1497Sport	ⓂⓄ 8041-1360Sport				
			Sport Kit			1140-1867	35	35	1,2,13,16, NO T V
<b>Civic USA Coupe (FG2) Si, DX</b> Front: for original struts only	06-12		Sport	ⓂⓄ◆ 8641-1497Sport					
<b>Civic Hybrid</b> Front: for original struts only	06-12		Sport	ⓂⓄ◆ 8641-1497Sport	ⓂⓄ 8041-1360Sport				
<b>CR-V</b>									
<b>CR-V (RD8)</b>	02-09-06		eavy Track		Ⓞ 8040-1320Sport				
<b>CR-V (RM) 2WD &amp; AWD</b>	01.12-16		Special-Active	Ⓞ 8745-1376L Ⓞ 8745-1376R	Ⓞ 8045-1377				
<b>Integra</b>									
<b>Integra Sedan / Coupé (DA9)</b> with the KONI Sport dampers the car can be lowered approx. 20 mm	90-93		Sport	P2ⓄⓂⓂⓂⓄ 8041-1200Sport	R1ⓄⓂⓂⓂⓄ 8041-1201Sport				On request
<b>Integra (DC2, DC4) excl. Type R</b>	94-98		STR.T	Ⓞ 8050-1011	Ⓞ 8050-1012				
			Sport	N6ⓄⓂⓂⓂⓄ 8041-1152Sport	R4ⓄⓂⓂⓂⓄ 8041-1153Sport				
<b>Integra Type R</b> with the KONI Sport dampers the car can be lowered approx. Fr-Rr: 25-15mm	98-01		STR.T	Ⓞ 8050-1011					
			Sport	N6ⓄⓂⓂⓂⓄ 8041-1152Sport	R4ⓄⓂⓂⓂⓄ 8041-1164Sport				
			Sport Kit			1140-5021	35	35	1,2,13,16, NO T V
<b>Legend</b>									
<b>Legend Sedan / Coupé (KA7 / KA8) 3.2i-V6</b> Front uses OE spring seat. With these dampers the car can be lowered approx. Fr-Rr: 20-15mm	91-93		Special	N4ⓄⓂⓄ 8240-1125	R4ⓄⓂⓄ 8240-1126				
<b>Passport</b>									
<b>Passport (4WD)</b>	95-01-98		eavy Track	Ⓞ 30-1365					
<b>Passport (4WD)</b>	02-98-04		eavy Track	Ⓞ 30-1663	Ⓞ 30-1664				
<b>Prelude</b>									
<b>Prelude (BB) incl. 4WS (4-wheel steering)</b> with the KONI Sport dampers the car can be lowered approx. Fr-Rr: 20-15mm	92-96		Sport	N4ⓄⓂⓂⓂⓄ 8041-1154LSport N4ⓄⓂⓂⓂⓄ 8041-1154RSport	R3ⓄⓂⓂⓂⓄ 8041-1155Sport				
<b>Prelude 2.0, 2.2 VTEC excl. SH (ATTS)</b> with the KONI Sport dampers the car can be lowered approx. Fr-Rr: 20-15mm	97-00		Sport	N4ⓄⓂⓂⓂⓄ 8041-1232Sport	R3ⓄⓂⓂⓂⓄ 8041-1155Sport				
<b>S2000</b>									
<b>S2000 Roadster</b> for Showa OE dampers only	99-08		STR.T	Ⓞ 8050-1117L Ⓞ 8050-1117R	Ⓞ 8050-1118				
			Sport	ⓂⓄ 8041-1278LSport ⓂⓄ 8041-1278RSport	ⓂⓄ 8041-1279Sport				
			STR.T Kit			1120-4171	25	25	1,2,13
			Sport Kit			1140-4171	25	25	1,2,13,16
<b>HYUNDAI</b>									
<b>Coupé</b>									
<b>Coupé</b> Front: for original Sachs struts 49 mm only	10.97-09.99		Sport	Ⓜ◆ 8610-1410Sport					
<b>Galloper</b>									
<b>Galloper 2.5TD, 3.0 V6</b> with coil springs	98-03		eavy Track	Ⓞ 30-1318	Ⓞ▲ 30-1408				
<b>H 100</b>									
<b>H 100 Van / Grace</b> Front: alternative for heavier loads	94-03		Special	Ⓞ 30-1326					
<b>H 200</b>									
<b>H 200 Van</b>	99-03		Special	Ⓞ 30-1365	Ⓞ▲ 30-1408				
<b>I30</b>									
<b>I30 (GD) Hatchback</b>	11.11-16		Sport	ⓂⓄ 8741-1584LSport ⓂⓄ 8741-1584RSport	Ⓞ 8240-1300Sport				
11.2011 - 2014			Sport Kit			1140-0836	30	35	1, 2, 13, 17
2015 Facelift, front axle load up to 960 kg			Sport Kit			1140-8310	25	25	1, 2, 13, 17
2015 Facelift, Front axle load as from 961 kg			Sport Kit			1140-8311	25	25	1, 2, 13, 17
<b>I30 (GD) Wagon</b>	11.11-16		Sport	ⓂⓄ 8741-1584LSport ⓂⓄ 8741-1584RSport	Ⓞ 8240-1300Sport				
11.2011-2014, front axle load up to 1010 kg			Sport Kit			1140-0836	25	40	1, 2, 13, 17

MAKE	Model	Year	product range				Lowering up to ..mm		Notes	
							Front	Rear		
<b>HYUNDAI - CONTINUED</b>										
<b>ix35</b>										
	ix35 2WD. Front: for original struts only	09-15	eavy Track	8641-1550		8240-1286				
	4WD. Front: for original struts only		eavy Track	8641-1550		8240-1287				
<b>Lantra</b>										
	Lantra / Elantra, Sedan / Wagon Front Rear: for original Sachs struts 49 mm only	10.97-05	Sport	8610-1410Sport						
<b>Santa Fe</b>										
	Santa Fe (CM) 2WD & 4WD excl. self-levelling systems	09.09-06.12	Special-Active	8745-1358L 8745-1358R		8245-1359				
	Santa Fe / Grand Santa Fe(DM) 2WD excl. self-levelling systems, Rear: Lmax 480mm	07.12-18	Special-Active	8745-1362L 8745-1362R		8245-1363				
	Santa Fe / Grand Santa Fe (DM) 4WD excl. self-levelling systems, Rear: Lmax 435mm	07.12-18	Special-Active	8745-1362L 8745-1362R		8245-1379				
<b>Sonata</b>										
	Sonata / XG	98-00	STR.T	8050-1119		8050-1120				
	Sonata / XG	01-04	STR.T	8050-1119		8050-1120				
<b>Tucson</b>										
	Tucson 2.0i, 2.7i V6, 2.0CRDi Front + Rear: for original struts only	04-09	Special-Active	8645-1151		8645-1152				
			eavy Track	8641-1503		8641-1504				
	Tucson (ix) 2WD	09-15	eavy Track	8641-1550		8240-1286				
	4WD		eavy Track	8641-1550		8240-1287				
<b>Veloster</b>										
	Veloster	11-15	Sport Sport Kit	8641-1553Sport		8040-1411Sport				
							1140-9021	25	25	1,2,13
<b>INFINITI</b>										
<b>G-series</b>										
	G35 Sedan / Coupé	03-06	Sport	M1 8241-1216LSport M1 8241-1216RSport		8241-1217Sport				
	G37 Coupé / Convertible excl. AWD	08-15	Sport Sport Kit	8241-1282LSport 8241-1282RSport		8241-1283Sport				
							1140-9589	30-35	25-30	1,2,13,16
<b>I-series</b>										
	I30 / I30T Sedan Front: for original struts only	96-99	Sport	8641-1362Sport						
	I30 / I35 Sedan Front: for original struts only	00-05	Sport	8641-1439Sport		M2 8040-1297Sport				
<b>ISUZU</b>										
<b>Campo</b>										
	Pickup, Crew Cab (4WD) TFS16/54 HD (EK4)	89-99	eavy Track	30-1365						
<b>D-Max</b>										
	D-Max 2WD	03-11	eavy Track			82-2590				
	D-Max 4WD	03-11	eavy Track		82-2591	82-2592				
	D-Max (TFR, TFS) 2WD	12-19	eavy Track			82-2608				
	D-Max (TFR, TFS) 4WD Fit vehicles with standard or raised suspension, Front Rear: 0 - 30 mm	12-19	eavy Track		82-2607SP1	82-2608				
	Fit vehicles with standard or raised suspension, Front Rear: 0 - 30 mm		T RAID		88-5395		90-5458			
<b>Gemini</b>										
	Gemini 1600 (PF50, PF60)	75-85	Classic Sport	80-2275 82-1886Sport						
<b>Pickup</b>										
	Pickup	82-83	eavy Track			80-2458				
<b>Rodeo</b>										
	Rodeo	90-97	eavy Track		30-1365					
	Rodeo (4WD)	98-04	eavy Track		30-1663	30-1664				
<b>Trooper</b>										
	Trooper (UBS13 / UBS52) 4WD up to chassisno. 4524288	84-86	eavy Track		30-1326					
	Trooper (UBS16 / UBS52) 4WD as from chassisno. 4524289	-87	eavy Track		30-1365					
	Trooper (UBS17 / UBS55) 4WD	88-91	eavy Track		30-1365					
	Trooper (UBS69) 4WD	92-02	eavy Track		30-1565	30-1566				
<b>Van</b>										
	Van (WFR 11) 2WD	80-89	eavy Track			80-1904				
<b>IVECO</b>										
<b>DAILY IV &amp; V 4x4</b>										
	35S17 W, 55S17 W, 55-170 Fit vehicles with standard or raised suspension, Front Rear: 0 - 40 mm	05.06-02.14	Special		88-1794	88-1795				
<b>JAGUAR</b>										
<b>E-type</b>										
	E-Type Series 1, 1½, 2 Coup , 2+2 Coup , Convertible. Rear: 4 pieces	61-71	Classic	82-1232		80-1491SPA1				
	E-Type Series 3 (V12) Coup , 2+2 Coup , Convertible. Rear: 4 pieces	71-75	Classic	80-2215		80-2216				

MAKE		Year	product range				Lowering up to ..mm		Notes
Model							Front	Rear	
<b>JAGUAR - CONTINUED</b>									
<b>Mk</b>									
Mk 240, 340		67-69	Classic	☳ 82-1019	☳☐ 82-1044				
Mk II 2.4 Litre, 3.4 Litre, 3.8 Litre		56-67	Classic	☳ 82-1019	☳☐ 82-1044				
Mk VII, VIII, IX		54-59	Classic	☳ 82-1027	☳ 82-1081				
<b>S</b>									
S 3.8 Litre		64-66	Classic	☳ 82-1019					
S 420		64-69	Classic	☳ 82-1019					
<b>XJ</b>									
XJ 6 Rear: 4 pieces		69-86	Classic	☳☐ 26-1089	MO☳☐☳☐☐ 30-1090				
XJ 6 3.2 Sport		10.94-10.97	Classic	☳☐ 26-1592	☳☐☐☐☐ 30-1593				
XJ 6 3.2/4.0 Saloon, Sovereign, incl. l.w.b.		10.94-10.97	Classic		☳☐☐☐☐ 30-1593				
XJ 8 excl. cars with Jaguar CATS suspension		10.97-03	Classic	☳☐ 26-1698	☳☐☐☐☐ 30-1593				
XJ 12 Rear: 4 pieces		72-02.93	Classic	☳☐ 26-1089	MO☳☐☳☐☐ 30-1090				
XJ 12 Saloon, incl. l.w.b.		10.94-10.97	Classic	☳☐ 26-1592	☳☐☐☐☐ 30-1593				
XJ-R Supercharged		10.94-10.97	Classic	☳☐ 26-1592	☳☐☐☐☐ 30-1593				
<b>XJ-S</b>									
XJ-S 12 Rear: 4 pieces		75-96	Classic	☳☐ 26-1089	MO☳☐☳☐☐ 30-1090				
<b>XK</b>									
XK 120		48-54	Classic	☳ 80-1105	△				
XK 140		54-57	Classic	☳ 82-1027	☳ 82-1081				
XK 150 / XK 150 S		57-61	Classic	☳ 82-1107					
<b>JEEP</b>									
<b>Cherokee</b>									
Cherokee, series XJ		84-01	eavy Track	☐ 30-1348	☐ 30-1630				
Cherokee, series KJ		01-07	eavy Track	☐ 8240-1201SP	☐ 8240-1202SP				
Cherokee, series KK		07-13	eavy Track	☐ 8240-1201SP	☐ 8240-1202SP				
<b>Commander</b>									
Commander 4WD series XH/XK		05-10	Special-Active eavy Track	☐ 8245-1223 ☐ 8240-1264	☐ 8245-1224 ☐ 8240-1265				
<b>Grand Cherokee</b>									
Grand Cherokee, series ZJ		93-98	eavy Track		☐☐ 8240-1199SP				
Grand Cherokee, series WJ		99-04	eavy Track	☐ 8240-1176SP	☐ 8240-1177SP				
Grand Cherokee, series WH, 4.7 V8, 5.7 V8, 3.0 CRD		05-11	Special-Active eavy Track	☐ 8245-1223 ☐ 8240-1264	☐ 8245-1224 ☐ 8240-1265				
<b>Liberty</b>									
Liberty, series KJ		01-07	eavy Track	☐ 8240-1201SP	☐ 8240-1202SP				
Liberty, series KK		07-13	eavy Track	☐ 8240-1201SP	☐ 8240-1202SP				
<b>Wagoneer</b>									
Wagoneer, series XJ		84-00	eavy Track	☐ 8240-1201SP	☐ 8240-1202SP				
<b>Wrangler</b>									
Wrangler, series TJ with coil springs		96-05	eavy Track	☐ 30-1348	☐ 30-1630				
Wrangler, series JK, 2.8 V6, 2.8 CRD		08.06-17	eavy Track	☐ 8240-1262	☐ 8240-1263				
<b>KIA</b>									
<b>Cee'd</b>									
Cee'd (5D) II excl. GT		05.12-18	Sport	☳☐ 8741-1584LSport ☳☐ 8741-1584RSport	☐ 8240-1300Sport				
Front axle load up to 960 kg			Sport Kit			1140-8661	25	40	1, 2, 13, 17
Front axle load as from 961 kg			Sport Kit		1140-8662	25	40	1, 2, 13, 17	
Cee'd SW II, excl. GT		05.12-18	Sport	☳☐ 8741-1584LSport ☳☐ 8741-1584RSport	☐ 8240-1300Sport				
Front axle load up to 960 kg				Sport Kit		1140-8663	25	40	1, 2, 13, 17
Front axle load as from 961 kg			Sport Kit		1140-8664	25	40	1, 2, 13, 17	
Pro Cee'd (3D) II excl. GT		05.12-18	Sport	☳☐ 8741-1584LSport ☳☐ 8741-1584RSport	☐ 8240-1300Sport				
Front axle load up to 960 kg				Sport Kit		1140-8661	25	40	1, 2, 13, 17
Front axle load as from 961 kg			Sport Kit		1140-8662	25	40	1, 2, 13, 17	
<b>Magentis</b>									
Magentis (MS)		00-05	STR.T	☐ 8050-1119	☐ 8050-1120				
<b>Optima</b>									
Optima (MS)		00-05	STR.T	☐ 8050-1119	☐ 8050-1120				
<b>Rio III</b>									
Rio III (UB)		12-17	STR.T	☐ 8750-1120L ☐ 8750-1120R	☐ 8050-1144				I.D.
			Sport	☐ 8740-1586LSport ☐ 8740-1586RSport	☐ 8040-1429Sport				
			STR.T Kit			1120-8991	30	30	2,13
			Sport Kit			1140-8991	30	30	2,13
<b>Sorento</b>									
Sorento (4WD) 2.4-16V, 2.5 CRDi, 3.5-V6 excl. self-levelling systems		02-05	Special-Active	☐ 8245-1042L ☐ 8245-1042R	☐☐ 8245-1043				
Sorento (4WD) 3.3 V6, 3.8 V6, 2.5 CRDi VGT excl. self-levelling systems		06.06-04.09	Special-Active	☐ 8245-1195L ☐ 8245-1195R	☐☐ 8245-1178				



MAKE	Model	Year	product range				Lowering up to .mm		Notes
							Front	Rear	
<b>KIA - CONTINUED</b>									
	<b>Sorento (XM)</b> 2WD 4WD	09-12-12	Special-Active	Ⓒ 8745-1358L Ⓒ 8745-1358R	ⓃⒸ 8245-1359				
	<b>Sorento (XM)</b> 2WD	01-12-12-14	Special-Active	Ⓒ 8745-1362L Ⓒ 8745-1362R	ⓃⒸ 8245-1363				
	<b>Sorento (XM)</b> AWD	01-12-11-14	Special-Active	Ⓒ 8745-1362L Ⓒ 8745-1362R	ⓃⒸ 8245-1379				
<b>Sportage</b>									
	<b>Sportage 2, 2.0, 2.7 V6, 2.0CRDi</b> 2WD 4WD. Front + Rear: for original struts only	09-04-10	Special-Active eavy Track	Ⓒ 8645-1151 ⓂⒸⒹ▲ 8641-1503	ⓃⒸ 8645-1152 ⓃⓂⒸⒹ▲ 8641-1504				
	<b>Sportage 3 (SL)</b> 2WD. Front: for original struts only	10-16	eavy Track	ⓂⒸⒹ▲ 8641-1550	Ⓒ 8240-1286				
	4WD. Front: for original struts only		eavy Track	ⓂⒸⒹ▲ 8641-1550	Ⓒ 8240-1287				
<b>LADA</b>									
<b>Diva</b>									
	<b>Diva, Forman, Sagona 1500 (2109)</b>	91-00	Special Sport	86-2380 ⓂⒸ 8641-1329Sport	M3ⒹⓂ□ 80-2586 M3ⒹⓂⓂⒸ 8041-1209Sport				
<b>Kalina</b>									
	<b>Kalina (1117, 1118, 1119)</b> Front: for original struts only	04-13	Sport	ⓂⒸⒹ▲ 8641-1545Sport	M3ⒹⓂⓂⒸ 8041-1209Sport				
<b>Niva</b>									
	<b>Niva (2121) 4WD</b>	78-09	eavy Track	Ⓒ 30-1324	Ⓒ 30-1325				
	<b>Niva (2123) 4WD</b>	02-05-14	eavy Track	Ⓒ 30-1703	Ⓒ 30-1704				
<b>Samara</b>									
	<b>Samara 1100, 1300 (2108)</b>	86-00	Special Sport	86-2380 ⓂⒸ 8641-1329Sport	M3ⒹⓂ□ 80-2586 M3ⒹⓂⓂⒸ 8041-1209Sport				
	<b>Samara (2110)</b>	97-03	STR.T	Ⓒ▲ 8650-1012	Ⓒ▲ 8050-1083				
<b>LANCIA</b>									
<b>Flavia</b>									
	<b>Flavia</b> as from chassisno. 815.000.1560	62-05-67	Classic	▼□ 80-1500	▼ 80-1501				
	<b>Flavia Zagato Sport</b>	64-66	Classic	▼□ 80-1500	▼ 80-1501				
	<b>Flavia</b>	06-67-72	Classic		▼ 80-1501				
<b>Fulvia</b>									
	<b>Fulvia, 1300C</b>	63-76	Classic	▼□ 80-1500	▼ 80-1501				
<b>Ypsilon</b>									
	<b>Ypsilon Y10, incl. Turbo</b>	85-92	Special		□ 80-2584				
	<b>Ypsilon</b>	96-03	STR.T STR.T Kit	Ⓒ 8750-1068	Ⓒ 8250-1018	1120-9521	40	40	1,2,13
<b>LAND ROVER (RANGE-ROVER)</b>									
<b>Discovery</b>									
	<b>Discovery 1</b>	89-94	eavy Track	Ⓒ 30-1311	Ⓒ 30-1312				
	NOTE: these dampers are only for vehicles raised 50mm.		eavy Track	Ⓒ 8240-1181SP	Ⓒ 8240-1190SP				
	Steering damper (not adjustable)		eavy Track	Ⓒ 30-1311SP1	Ⓒ 30-1312SP1				
	RAID Dampers: fit vehicles with standard or raised suspension, Front: 0 - 50 mm Rear: 0 - 40 mm		T RAID	90-5374SP1	90-5375SP1				
	RAID Dampers: for raised suspension 40 - 60 mm only		T RAID		90-5401				
	<b>Discovery 1, as from series MA</b>	94-98	eavy Track	Ⓒ 30-1311					
	NOTE: these dampers are only for vehicles raised 50mm - additional parts are needed		eavy Track	Ⓒ 30-1311SP1					
	Steering damper (not adjustable)		eavy Track	Ⓒ 026-1580					
	RAID Dampers: fit vehicles with standard or raised suspension, Front: 0 - 50 mm Rear: 0 - 40 mm		T RAID	90-5374SP1	90-5375SP1				
	RAID Dampers: for raised suspension 40 - 60 mm only	T RAID		90-5401					
	<b>Discovery 2, as from series MY</b> incl. air suspension	99-04	eavy Track	Ⓒ 8240-1178SP	Ⓒ 8240-1179SP				
	<b>Discovery 3 / LR3</b> For OEM Air Suspension equipped models only. (Air bellow needs to be transferred to KONI shock)	04-09-09	T RAID-Active	9905-1003	9905-1004				
	<b>Discovery 4 / LR4</b> For OEM Air Suspension equipped models only. (Air bellow needs to be transferred to KONI shock)	10-09-16	T RAID-Active	9905-1003	9905-1004				
<b>Land Rover (Defender)</b>									
	<b>Defender 90</b>	84-99	eavy Track	Ⓒ 30-1311					
	<b>Defender 90</b> as from serie no. A159807	99-16	eavy Track	Ⓒ 8240-1181SP	Ⓒ 8240-1182SP				
	<b>Defender 90</b> RAID Dampers: fit vehicles with standard or raised suspension, Front: 0 - 50 mm Rear: 0 - 40 mm	84-16	T RAID	90-5374SP1	90-5375SP1				
	RAID Dampers: for raised suspension 40 - 60 mm only		T RAID		90-5401				
	<b>Defender 110</b>	83-99	eavy Track	Ⓒ 30-1311	Ⓒ 30-1312				
	<b>Defender 110</b> as from serie no. A159807	99-16	eavy Track	Ⓒ 8240-1181SP	Ⓒ 8240-1182SP				
	<b>Defender 110</b> RAID Dampers: fit vehicles with standard or raised suspension, Front: 0 - 50 mm Rear: 0 - 40 mm	84-16	T RAID	90-5374SP1	90-5375SP1				
	RAID Dampers: for raised suspension 40 - 60 mm only		T RAID		90-5401				
	<b>Defender 130</b> as from serie no. A159807	99-16	eavy Track	Ⓒ 8240-1181SP	Ⓒ 8240-1182SP				

MAKE		Year	product range				Lowering up to ..mm		Notes
Model							Front	Rear	
<b>LAND ROVER (RANGE-ROVER) - CONTINUED</b>									
	RAID Dampers: fit vehicles with standard or raised suspension, Front: 0 - 50 mm Rear: 0 - 40 mm		T RAID	90-5374SP1	90-5375SP1				
	RAID Dampers: for raised suspension 40 - 60 mm only		T RAID		90-5401				
<b>Range Rover</b>									
	<b>Range Rover</b> excl. air suspension	71-94	eavy Track	Ⓞ 30-1311	Ⓞ 30-1312				
	RAID Dampers: fit vehicles with standard or raised suspension, Front: 0 - 50 mm Rear: 0 - 40 mm		eavy Track	Ⓞ 8240-1181SP	Ⓞ 8240-1190SP				
	RAID Dampers: for raised suspension 40 - 60 mm only		T RAID	90-5374SP1	90-5375SP1				
			T RAID		90-5401				
	<b>Range Rover 4.0 Vogue, 4.2 LSE</b> Steering damper (not adjustable)	93-94	eavy Track	Ⓞ O26-1580					
	<b>Range Rover Classic, excl. air-suspension</b> excl. models with anti-roll bar rear	94-96	eavy Track	Ⓞ 30-1311	Ⓞ 30-1312				
	with anti-roll bar rear		eavy Track	Ⓞ 8240-1181SP	Ⓞ 8240-1190SP				
	Steering damper (not adjustable)		eavy Track	Ⓞ 30-1311					
	RAID Dampers: fit vehicles with standard or raised suspension, Front: 0 - 50 mm Rear: 0 - 40 mm		T RAID	90-5374SP1	90-5375SP1				
	RAID Dampers: for raised suspension 40 - 60 mm only		T RAID		90-5401				
	<b>Range Rover Mk2, excl Classic</b> with air-suspension	95-01	eavy Track	Ⓞ 30-1597	Ⓞ 30-1598				
<b>LEXUS</b>									
<b>IS</b>									
	<b>IS (Altezza) 200, 300 Sedan</b> with these KONI Sport dampers the car can be lowered Fr-Rr approx. 20-15mm (excl. Lexus Sport Susp.)	98-05	STR.T	Ⓞ 8050-1115	Ⓞ 8050-1116				
	Front axle load up to 900 kg, rear axle load up to 1020 kg		Sport	N3ⓄⓄⓄⓄ 8041-1264Sport	N2ⓄⓄⓄⓄ 8041-1265Sport				
	STR.T Kit					1120-4351	35	35	1,2,13,15
	Sport Kit					1140-4351	35	35	1,2,13,15,16
	Front axle load as from 901 kg, rear axle load up to 1020 kg		STR.T Kit			1120-4353	35	35	1,2,13,15
			Sport Kit			1140-4353	35	35	1,2,13,15,16
	<b>IS (Altezza) 200, 300 SportCross</b> with these KONI Sport dampers the car can be lowered Fr-Rr approx. 20-15mm (excl. Lexus Sport Susp.)	98-05	STR.T	Ⓞ 8050-1115	Ⓞ 8050-1116				
	Front axle load up to 900 kg, rear axle load as from 1021 kg		Sport	N3ⓄⓄⓄⓄ 8041-1264Sport	N2ⓄⓄⓄⓄ 8041-1265Sport				
	STR.T Kit					1120-4354	35	35	1,2,13,15
	Sport Kit					1140-4354	35	35	1,2,13,15,16
	Front axle load as from 901 kg, rear axle load as from 1021 kg		STR.T Kit			1120-4352	35	35	1,2,13,15
			Sport Kit			1140-4352	35	35	1,2,13,15,16
	<b>IS 250, 350, 200d, 220d</b> excl. IS-F, AWD	06-08.13	Sport		ⓄⓄ▲ 8241-1285Sport				
<b>LX</b>									
	<b>LX 450</b> with coil springs	96-98	eavy Track	Ⓞ 30-1426	Ⓞ 30-1427				
	RAID Dampers: fit vehicles with standard or raised suspension, Front Rear: 0 - 50 mm		T RAID	90-5389SP2	90-5390SP2				
<b>MAZDA</b>									
<b>2 (Demio)</b>									
	<b>2</b>	04-07	STR.T	Ⓞ 8750-1081L	Ⓞ 8050-1103				
				Ⓞ 8750-1081R					
			STR.T Kit			1120-2641	30	30	1,2,13
<b>3 (Axela)</b>									
	<b>3 Sedan / Hatchback</b> incl. Ma da Sport Suspension	03-12.08	Special-Active	Ⓞ 8745-1110L	Ⓞ 8045-1097				
	Front axle load up to 994 kg		STR.T	Ⓞ 8750-1087L	Ⓞ 8050-1107				
				Ⓞ 8750-1087R					
	Sport		ⓄⓄ 8741-1487LSport	Ⓞ 8040-1354Sport					
	STR.T Kit		ⓄⓄ 8741-1487RSport			1120-2281	30	30	1,2,13
	Sport Kit					1140-2281	30	30	1,2,13,17
	Front axle load as from 995 kg		STR.T Kit			1120-2282	30	30	1,2,13
			Sport Kit			1140-2282	30	30	1,2,13,17
	<b>3 MPS / Mazdaspeed3</b>	06-12.08	Special-Active	Ⓞ 8745-1110L	Ⓞ 8045-1097				
				Ⓞ 8745-1110R					
	STR.T		Ⓞ 8750-1088L	Ⓞ 8050-1140					
			Ⓞ 8750-1088R						
	Sport	ⓄⓄ 8741-1490LSport	Ⓞ 8040-1354Sport						
	STR.T Kit		ⓄⓄ 8741-1490RSport			1120-1791	25	25	1,2,13
	Sport Kit					1140-1791	25	25	1,2,13,17
	<b>3 Sedan / Hatchback</b> incl. Ma da Sport Suspension	01.09-13	Special-Active	Ⓞ 8045-1068	Ⓞ 8050-1108				
	STR.T		Ⓞ 8750-1087L	Ⓞ 8050-1108					
			Ⓞ 8750-1087R						
	Sport	ⓄⓄ 8741-1487LSport	Ⓞ 8040-1351Sport						
	STR.T Kit		ⓄⓄ 8741-1487RSport			1120-2283	30	30	1,2,13
	Sport Kit					1140-2283	30	30	1,2,13,17
	Front axle load up to 994 kg		STR.T Kit			1120-2284	30	30	1,2,13
			Sport Kit			1140-2284	30	30	1,2,13,17
	<b>3 Sedan / Hatchback</b> Front axle load as from 995 kg	01.09-13	STR.T Kit			1120-2284	30	30	1,2,13
			Sport Kit				1140-2284	30	30

MAKE		Year	product range				Lowering up to ..mm		Notes
Model	Front						Rear		
<b>MAZDA - CONTINUED</b>									
3 MPS / Mazdaspeed3	01.09-13	Special-Active	Ⓒ 8745-1110L Ⓒ 8745-1110R	Ⓒ 8045-1096					
		STR.T	Ⓒ 8750-1088L Ⓒ 8750-1088R	Ⓒ 8050-1109					
		Sport	ⓂⒸ 8741-1490LSport ⓂⒸ 8741-1490RSport	Ⓒ 8040-1353Sport					
		STR.T Kit Sport Kit			1120-2285 1140-2285	30 30	30 30	1,2,13 1,2,13,17	
3 Sedan / Hatchback (BM/BN)	13-18	Sport	ⓂⒸ 8741-1577LSport ⓂⒸ 8741-1577RSport	Ⓒ 8040-1422Sport					
		For Petrol engines only	Sport Kit		1140-8211	30	45	1, 2, 13, 17	
		For Diesel engines only	Sport Kit		1140-8212	30	45	1, 2, 13, 17	
<b>5 (Premacy)</b>									
5, all	05-10	Special-Active	Ⓒ 8745-1110L Ⓒ 8745-1110R	Ⓒ 8045-1097					
		STR.T	Ⓒ 8750-1088L Ⓒ 8750-1088R	Ⓒ 8050-1140					
		Sport	ⓂⒸ 8741-1490LSport ⓂⒸ 8741-1490RSport	Ⓒ 8040-1354Sport					
		1.8, 2.0 2.0 CD	Sport Kit Sport Kit		1140-1521 1140-1522	40 40	40 40	1,2,13,17 1,2,13,17	
5, all	10-17	Special-Active	Ⓒ 8745-1110L Ⓒ 8745-1110R	Ⓒ 8045-1097					
		STR.T	Ⓒ 8750-1088L Ⓒ 8750-1088R	Ⓒ 8050-1140					
		Sport	ⓂⒸ 8741-1490LSport ⓂⒸ 8741-1490RSport	Ⓒ 8040-1354Sport					
		2.0	Sport Kit		1140-1521	40	40	1,2,13,17	
5, all 1.6 CD	10-13	Sport Kit				1140-1522	40	40	1,2,13,17
<b>6 (Atenza)</b>									
6 Sedan, Hatchback (GG), excl. 4WD Front: for original struts only	02-08	Sport	ⓂⒸⓈ 8041-1305Sport	Ⓒ 8040-1306Sport					
		1.8, 2.0, 2.3 2.0 DI	Sport Kit Sport Kit		1140-3111 1140-3113	35 35	35 35	1,2,13,16 1,2,13,16	
		6 SportBreak (GG), excl. 4WD Front: for original struts only	02-08	Sport	ⓂⒸⓈ 8041-1305Sport	Ⓒ 8040-1306Sport			
1.8, 2.0, 2.3 2.0 DI	Sport Kit Sport Kit			1140-3112 1140-3114	35 35	35 35	1,2,13,16 1,2,13,16		
6 Sedan, Hatchback (GH), excl. 4WD Front: for original struts only	07-13	Sport		ⓂⒸⓈ 8041-1401Sport	Ⓒ 8240-1276Sport				
Front axle load up to 1040 kg Front axle load as from 1041 kg		Sport Kit Sport Kit		1140-0331 1140-0332	35 35	35 35	1,2,13,17 1,2,13,17		
6 SportBreak (GH), excl. 4WD Front: for original struts only		07-13	Sport	ⓂⒸⓈ 8041-1401Sport	Ⓒ 8240-1276Sport				
6 SportBreak (GH), excl. 4WD Front axle load up to 1040 kg Front axle load as from 1041 kg	Sport Kit Sport Kit			1140-0333 1140-0334	35 35	35 35	1,2,13,17 1,2,13,17		
6 Sedan (GJ/GL)	13-19	Sport	ⓂⒸ 8741-1578LSport ⓂⒸ 8741-1578RSport	Ⓒ 8040-1423Sport					
		For Petrol engines only, front axle load up to 1025 kg For Petrol engines only, front axle load as from 1026 kg	Sport Kit Sport Kit		1140-8381 1140-8382	30 30	30 30	1, 2, 13, 17 1, 2, 13, 17	
		For Diesel engines only	Sport Kit		1140-8383	30	30	1, 2, 13, 17	
		6 SportBreak (GJ/GL)	12-19	Sport	ⓂⒸ 8741-1578LSport ⓂⒸ 8741-1578RSport	Ⓒ 8040-1423Sport			
For Petrol engines only, front axle load up to 1025 kg For Petrol engines only, front axle load as from 1026 kg	Sport Kit Sport Kit			1140-8384 1140-8385	30 30	30 30	1, 2, 13, 17 1, 2, 1, 17		
For Diesel engines only	Sport Kit			1140-8386	30	30	1, 2, 13, 17		
	Sport Kit			1140-8386	30	30	1, 2, 13, 17		
<b>CX-5</b>									
CX-5 (KE) 2WD & 4WD	12-06-17	Special-Active	Ⓒ 8745-1346L Ⓒ 8745-1346R	ⓃⒸ 8045-1347					
		Sport	ⓂⒸ 8741-1579LSport ⓂⒸ 8741-1579RSport	ⓃⒸ 8040-1424Sport					
		For Petrol engines only	Sport Kit		1140-8751	30	45	1, 2, 13, 17	
		For Diesel engines only	Sport Kit		1140-8752	30	45	1, 2, 13, 17	
<b>BT-50</b>									
BT-50 (UP/UR) 4x2 Low	10.11-19	heavy Track	82-2601	82-2602					
BT-50 (UP/UR) 4x2 Hi-Rider & 4x4 Fit vehicles with standard or raised suspension, Front Rear: 0 - 30 mm	10.11-19	heavy Track	82-2603SP1	82-2604					
		T RAID	88-1817	90-5474					
<b>MX-5</b>									
MX-5 / Miata NA / Eunos Roadster 1.6-16V, 1.8-16V with the KONI Sport dampers the car can be lowered approx. Fr-Rr: 20-15mm	89-97	STR.T	Ⓒ 8050-1041	Ⓒ 8050-1042					
		Sport	ⓂⒸⓈ 8041-1203Sport	R1ⓂⓈⓈ 8041-1204Sport					
		STR.T Kit			1120-8391	40	40	1,2,13	
		Sport Kit			1140-8391	40	40	1,2,13,16	

MAKE		Year	product range				Lowering up to ..mm		Notes	
Model	Front						Rear			
<b>MAZDA - CONTINUED</b>										
MX-5 / Miata NB 1.6, 1.8	98-05	STR.T	Ⓒ 8050-1043	Ⓒ 8050-1044						
		Sport	ⓂⒸ 8041-1251Sport	ⓂⒸ 8041-1252Sport						
		STR.T Kit			1120-4871	35	35	1,2,13		
		Sport Kit			1140-4871	35	35	1,2,13,16		
MX-5 / Miata NC 1.8, 2.0	05-13	STR.T	Ⓒ 8250-1034	Ⓒ 8250-1035						
		Sport	ⓂⒸ 8241-1243Sport	ⓂⒸ 8241-1244Sport						
		STR.T Kit			1120-1351	40	40	1, 2, 13		
		Sport Kit			1140-1351	40	40	1,2,13,16		
MX-5 / Miata ND 1.5, 2.0 incl. Bilstein OEM Sport Susp.  with these KONI Sport dampers icw the MA DA std. OEM Springs the car can be lowered approx. 30 mm (by means of clipped spring seat)	15-19	Sport	ⓂⒸ▲ 8241-1310Sport	ⓂⒸ▲ 8241-1311Sport						
		Sport Kit			1140-8764-1	30	30	1, 2, 13, 16		
		Sport	ⓂⒸ 8241-1304Sport	ⓂⒸ 8241-1305Sport					I.D.	
<b>RX-8</b>										
RX-8	03-07	STR.T	Ⓒ 8250-1040	Ⓒ 8250-1041						
		Sport	ⓂⒸ 8241-1226Sport	Ⓒ 8240-1227Sport						
		Sport Kit			1140-2231	45	45	1,2,13,17		
RX-8 for Showa OE dampers only	08-08	STR.T	Ⓒ 8250-1040	Ⓒ 8250-1041						
		Sport	ⓂⒸ 8241-1226Sport	Ⓒ 8240-1227Sport						
		Sport Kit			1140-2231	45	45	1,2,13,17		
for Bilstein OE dampers only		STR.T	Ⓒ 8250-1040	Ⓒ 8250-1042						
		Sport	ⓂⒸ 8241-1226Sport	Ⓒ 8240-1280Sport						
		Sport Kit			1140-2232	45	45	1, 2, 13, 17		
RX-8	09-12	STR.T	Ⓒ 8250-1040	Ⓒ 8250-1042						
		Sport	ⓂⒸ 8241-1226Sport	Ⓒ 8240-1280Sport						
		Sport Kit			1140-2232	45	45	1,2,13,17		
<b>MERCEDES-BENZ</b>										
<b>190-series (W201)</b>										
190, 190E, 190D excl. 2.3 and 2.5-16V	83-93	STR.T	Ⓒ 8750-1067	Ⓒ 8050-1060						
		Sport	ⓂⒸ 8741-1092Sport	Ⓒ 26-1198Sport						
190E 2.3-16V	84-90	STR.T	Ⓒ 8750-1067	△						
		Sport	ⓂⒸ 8741-1092Sport	△						
<b>A-Class (W176), B-Class (W246)</b>										
160 (CDi), 180 (CDi), 200 (CDi), 220 (CDi), 250 With Sport suspension, excl. 4Matic, 45 AMG	13-18	STR.T	Ⓒ 8750-1121L Ⓒ 8750-1121R	Ⓒ 8050-1145						
		Sport	ⓂⒸ 8741-1576LSport ⓂⒸ 8741-1576RSport	Ⓒ 8040-1421Sport						
		Front axle load up to 1020 kg	STR.T Kit			1120-8881-1	30	30	1,2,13	
			Sport Kit			1140-8881-1	30	30	1,2,13,17	
		Front axle load as from 1021 kg	STR.T Kit			1120-8881-2	30	30	1,2,13	
		Sport Kit			1140-8881-2	30	30	1,2,13,17		
<b>CLA-Class (C117)</b>										
160 (CDi), 180 (CDi), 200 (CDi), 220 (CDi), 250 Incl. Sport suspension, excl. 4Matic, 45AMG	01.13-18	STR.T	Ⓒ 8750-1121L Ⓒ 8750-1121R	Ⓒ 8050-1145						
		Sport	ⓂⒸ 8741-1576LSport ⓂⒸ 8741-1576RSport	Ⓒ 8040-1421Sport						
		Front axle load up to 1020 kg	STR.T Kit			1120-8881-3	30	30	1,2,13,	
			Sport Kit			1140-8881-3	30	30	1,2,13,17	
		Front axle load as from 1021 kg	STR.T Kit			1120-8881-4	30	30	1,2,13	
		Sport Kit			1140-8881-4	30	30	1,2,13,17		
<b>CLA-Class (X117)</b>										
CLA-Class (X117) Shooting Brake Incl. Sport suspension, excl. 4Matic, 45AMG	15-18	STR.T	Ⓒ 8750-1121L Ⓒ 8750-1121R	Ⓒ 8050-1145						
		Sport	ⓂⒸ 8741-1576LSport ⓂⒸ 8741-1576RSport	Ⓒ 8040-1421Sport						
		STR.T Kit			1120-8584	25	25	1,2,13		
		Sport Kit			1140-8584	25	25	1,2,13,17		
<b>C-Class (W202)</b>										
Sedan Incl. sport suspension	93-00	STR.T	Ⓒ 8050-1064	Ⓒ 8050-1065						
		Sport	Ⓒ 26-1575Sport	Ⓒ 26-1576Sport						
		Sport	ⓂⒸ 8041-1315Sport	ⓂⒸ 8041-1316Sport						
Sedan C180, C200, C200K, C220, C230K, C200D, C220D C280, C250D, C250TD	93-12.95	STR.T Kit			1120-9261	40	40	1,2,13,15		
		Sport Kit			1140-9261	40	40	1,2,13,15,16		
		STR.T Kit			1120-9271	40	40	1,2,13,15		
		Sport Kit			1140-9271	40	40	1,2,13,15,16		
Sedan C180, C200, C200K, C220, C230, C230K, C200D, C220D, C220CDI C240, C280, C250D, C250TD	01.96-00	STR.T Kit			1120-7491	40	40	1,2,13,15		
		Sport Kit			1140-7491	40	40	1,2,13,15,16		
		STR.T Kit			1120-7492	40	40	1,2,13,15		
		Sport Kit			1140-7492	40	40	1,2,13,15,16		
Combi Incl. sport suspension	01.96-00	STR.T	Ⓒ 8050-1064	Ⓒ 8050-1065						
		Sport	Ⓒ 26-1575Sport	Ⓒ 26-1576Sport						
		Sport	ⓂⒸ 8041-1315Sport	ⓂⒸ 8041-1316Sport						
		STR.T Kit			1120-7491	40	40	1,2,13,15		
		Sport Kit			1140-7491	40	40	1,2,13,15,16		
C180, C200, C200K, C220, C230, C230K, C200D, C220D, C220CDI C240, C280, C250D, C250TD		STR.T Kit			1120-7492	40	40	1,2,13,15		
		Sport Kit			1140-7492	40	40	1,2,13,15,16		
		STR.T Kit			1120-7492	40	40	1,2,13,15		
		Sport Kit			1140-7492	40	40	1,2,13,15,16		

MAKE		Year	product range				Lowering up to ..mm		Notes
Model							Front	Rear	
<b>MERCEDES-BENZ - CONTINUED</b>									
<b>C 36 AMG, C 43 AMG</b>		08.97-01	Sport Sport Kit	ⓂⓄ 8041-1315Sport	ⓂⓄ 8041-1316Sport			1140-3771 25 25	1,2,3,15,16
<b>C-Class (W203)</b>									
<b>Sport Coupé</b>		06.00-08	STR.T Sport STR.T Kit Sport Kit	Ⓞ 8750-1077 ⓂⓄ 8741-1412Sport	Ⓞ 8050-1122 ⓂⓄ 8041-1319Sport			1120-3921 1140-3921 40 40	40 40 1,2,13,15 1,2,13,15,16
<b>Sedan excl. 4Matic (AWD)</b>		06.00-06	STR.T Sport STR.T Kit Sport Kit	Ⓞ 8750-1077 ⓂⓄ 8741-1412Sport	Ⓞ 8050-1122 ⓂⓄ 8041-1319Sport			1120-3921 1140-3921 40 40	40 40 1,2,13,15 1,2,13,15,16
C160, C180, C180K, C200K, C230, C230K, C240, C280, C320, C350								1120-3921 1140-3921 40 40	40 40 1,2,13,15 1,2,13,15,16
C200CDI, C220CDI, C270CDI, C320CDI								1120-3921 1140-3921 40 40	40 40 1,2,13,15 1,2,13,15,16
<b>Combi excl. 4Matic (AWD)</b>		03.01-06	STR.T Sport STR.T Kit Sport Kit	Ⓞ 8750-1077 ⓂⓄ 8741-1412Sport	Ⓞ 8050-1122 ⓂⓄ 8041-1319Sport			1120-3922 1140-3922 40 40	40 40 1,2,13,15 1,2,13,15,16
C160, C180, C180K, C200K, C230, C230K, C240, C280, C320, C350								1120-3922 1140-3922 40 40	40 40 1,2,13,15 1,2,13,15,16
C200CDI, C220CDI, C270CDI, C320CDI								1120-3922 1140-3922 40 40	40 40 1,2,13,15 1,2,13,15,16
<b>C-Class (W204)</b>									
<b>C-Class (W204) Sedan</b> excl.: Advanced Agility Control, air suspension, D suspension, 4Matic		07-13	Special-Active STR.T Sport STR.T Kit Sport Kit	Ⓞ 8745-1295 Ⓞ 8750-1119 ⓂⓄ 8741-1554Sport	Ⓞ 8045-1296 Ⓞ 8050-1143 Ⓞ 8040-1412Sport			1120-0761 1140-0761 30 30	30 30 1,2,13 1,2,13,17
Front axle load up to 1020 kg								1120-0762 1140-0762 30 30	30 30 1,2,13 1,2,13,17
Front axle load as from 1021 kg								1120-0762 1140-0762 30 30	30 30 1,2,13 1,2,13,17
<b>C-Class (W204) Combi</b> excl.: Advanced Agility Control, air suspension, D suspension, 4Matic, Self-leveling system		07-13	Special-Active STR.T Sport STR.T Kit Sport Kit	Ⓞ 8745-1295 Ⓞ 8750-1119 ⓂⓄ 8741-1554Sport	Ⓞ 8045-1296 Ⓞ 8050-1143 Ⓞ 8040-1412Sport			1120-0763 1140-0763 20 20	20 20 1,2,13 1,2,13,15,17
Front axle load up to 1020 kg								1120-0764 1140-0764 20 20	20 20 1,2,13 1,2,13,15,17
Front axle load as from 1021 kg								1120-0764 1140-0764 20 20	20 20 1,2,13 1,2,13,15,17
<b>C-Class (W205)</b>									
<b>C-Class (W205) Sedan</b> excl. 4Matic (4WD), AMG, Airmatic (air suspension)		12.13-19	Special-Active Sport Sport Kit	Ⓞ 8045-1379 Ⓞ 8040-1430Sport	Ⓞ 8045-1380 Ⓞ 8040-1431Sport			1140-8111 1140-8112 45 45	35 35 1,2,13 1,2,13
For Petrol engines only								1140-8113 1140-8114 45 45	35 35 1,2,13 1,2,13
For Diesel engines only								1140-8113 1140-8114 45 45	35 35 1,2,13 1,2,13
<b>C-Class (W205) Combi</b> excl. 4Matic (4WD), AMG, Airmatic (air suspension)		12.13-19	Special-Active Sport Sport Kit	Ⓞ 8045-1379 Ⓞ 8040-1430Sport	Ⓞ 8045-1380 Ⓞ 8040-1431Sport			1140-8113 1140-8114 45 45	35 35 1,2,13 1,2,13
For Petrol engines only								1140-8113 1140-8114 45 45	35 35 1,2,13 1,2,13
For Diesel engines only								1140-8113 1140-8114 45 45	35 35 1,2,13 1,2,13
<b>CLC-Class (CL203)</b>									
<b>CLC 160BE, 180K, 200K, 250, 350, 200CDI, 220CDI</b>		05.08-11	STR.T Sport STR.T Kit Sport Kit	Ⓞ 8750-1077 ⓂⓄ 8741-1412Sport	Ⓞ 8050-1122 ⓂⓄ 8041-1319Sport			1120-3921 1140-3921 40 40	40 40 1,2,13,15 1,2,13,15,16
<b>CLK-Class (W208)</b>									
<b>Coupé CLK200, CLK200K, CL230, CLK230K</b>		96-02	STR.T Sport Sport STR.T Kit Sport Kit	Ⓞ 8050-1064 Ⓞ 26-1575Sport ⓂⓄ 8041-1315Sport	Ⓞ 8050-1065 Ⓞ 26-1576Sport Ⓞ 8041-1316Sport			1120-7491 1140-7491 40 40	40 40 1,2,13,15 1,2,13,15,16
<b>Coupé CLK320</b>		96-02	STR.T Sport Sport STR.T Kit Sport Kit	Ⓞ 8050-1064 Ⓞ 26-1575Sport ⓂⓄ 8041-1315Sport	Ⓞ 8050-1065 Ⓞ 26-1576Sport Ⓞ 8041-1316Sport			1120-7492 1140-7492 40 40	40 40 1,2,13,15 1,2,13,15,16
<b>Coupé CLK430</b>		96-02	STR.T Sport Sport STR.T Kit Sport Kit	Ⓞ 8050-1064 Ⓞ 26-1575Sport ⓂⓄ 8041-1315Sport	Ⓞ 8050-1065 Ⓞ 26-1576Sport ⓂⓄ 8041-1316Sport			1120-3771 1140-3771 25 25	25 25 1,2,13,15 1,2,13,15,16
<b>Coupé CLK 55 AMG</b>		96-02	Sport Sport Kit	ⓂⓄ 8041-1315Sport	ⓂⓄ 8041-1316Sport			1140-3771 25 25	1,2,13,15,16
<b>Cabrio CLK200, CLK200K, CLK230K</b>		96-02	STR.T Sport Sport STR.T Kit Sport Kit	Ⓞ 8050-1064 Ⓞ 26-1575Sport ⓂⓄ 8041-1315Sport	Ⓞ 8050-1065 Ⓞ 26-1576Sport ⓂⓄ 8041-1316Sport			1120-7493 1140-7493 40 40	40 40 1,2,13,15 1,2,13,15,16
<b>Cabrio CLK320, CLK430</b>		96-02	STR.T Sport Sport STR.T Kit Sport Kit	Ⓞ 8050-1064 Ⓞ 26-1575Sport ⓂⓄ 8041-1315Sport	Ⓞ 8050-1065 Ⓞ 26-1576Sport ⓂⓄ 8041-1316Sport			1120-7494 1140-7494 40 40	40 40 1,2,13,15 1,2,13,15,16

MAKE	Model	Year	product range				Lowering up to ..mm		Notes
							Front	Rear	
<b>MERCEDES-BENZ - CONTINUED</b>									
	Cabrio CLK 55 AMG	96-02	Sport Sport Kit	ⓂⓂⓂ 8041-1315Sport	ⓂⓂⓂ 8041-1316Sport			1140-3771 25 25	1,2,13,15,16
<b>CLK-Class (W209)</b>									
	Coupé CLK200, 200K, 240, 280, 320, 350	03.02-09	STR.T	ⓂⓂⓂ 8750-1077	ⓂⓂⓂ 8050-1122				
			Sport	ⓂⓂⓂ 8741-1412Sport	ⓂⓂⓂ 8041-1319Sport				
			STR.T Kit Sport Kit			1120-3921 1140-3921	40 40	40 40	1,2,13,15 1,2,13,15,16
	Coupé CLK220CDI, 270CDI, 320CDI	03.02-09	STR.T	ⓂⓂⓂ 8750-1077	ⓂⓂⓂ 8050-1122				
			Sport	ⓂⓂⓂ 8741-1412Sport	ⓂⓂⓂ 8041-1319Sport				
			STR.T Kit Sport Kit			1120-3921 1140-3921	40 40	40 40	1,2,13,15 1,2,13,15,16
	Coupé CLK500	03.02-09	STR.T	ⓂⓂⓂ 8750-1077	ⓂⓂⓂ 8050-1122				
			Sport	ⓂⓂⓂ 8741-1412Sport	ⓂⓂⓂ 8041-1319Sport				
			STR.T Kit Sport Kit			1120-3923 1140-3923	40 40	40 40	1,2,13,15 1,2,13,15,16
	Coupé CLK 55 AMG, CLK 63 AMG	03.02-09	Sport	ⓂⓂⓂ 8741-1412Sport	ⓂⓂⓂ 8041-1319Sport				
	Only CLK 55 AMG		Sport Kit			1140-3923	40	40	1,2,13,15,16
	Cabrio CLK200, 200K, 240, 280, 320, 350	03.02-09	STR.T	ⓂⓂⓂ 8750-1077	ⓂⓂⓂ 8050-1122				
			Sport	ⓂⓂⓂ 8741-1412Sport	ⓂⓂⓂ 8041-1319Sport				
			STR.T Kit Sport Kit			1120-2591 1140-2591	35 35	35 35	1,2,13,15 1,2,13,15,16
	Cabrio CLK500, 320CDI	03.02-09	STR.T	ⓂⓂⓂ 8750-1077	ⓂⓂⓂ 8050-1122				
			Sport	ⓂⓂⓂ 8741-1412Sport	ⓂⓂⓂ 8041-1319Sport				
			STR.T Kit Sport Kit			1120-2592 1140-2592	35 35	35 35	1,2,13,15 1,2,13,15,16
	Cabrio CLK 55 AMG, CLK 63 AMG	03.02-09	Sport	ⓂⓂⓂ 8741-1412Sport	ⓂⓂⓂ 8041-1319Sport				
	Only CLK 55 AMG		Sport Kit			1140-2592	35	35	1,2,13,15,16
<b>(W111)</b>									
	Sedan & Coupé	59-68	Classic	ⓂⓂⓂ 80-1415	ⓂⓂⓂ 80-1416				
	Combi / Colonia	62-67	Classic	ⓂⓂⓂ 80-1415					
<b>(W114) (W115)</b>									
	Sedan & Coupé	68-76	Classic	ⓂⓂⓂ 26-1019	ⓂⓂⓂ 30-1020				
<b>E-Class (W123)</b>									
	Sedan & Coupé	76-85	Classic	ⓂⓂⓂ 26-1157	ⓂⓂⓂ 30-1020				
	200D, 220D, 240D (taxi-cars)	76-85	Classic	ⓂⓂⓂ 26-1157	ⓂⓂⓂ 30-1020				
	Combi, 300D Ambulance (S123)	77-85	Classic	ⓂⓂⓂ 26-1157	△				
<b>E-Class (W124) (C124)</b>									
	Sedan / Coupé, excl. Sportline excl. 4Matic (AWD)	85-95	STR.T Sport	ⓂⓂⓂ 8750-1067 ⓂⓂⓂ 8741-1092Sport	ⓂⓂⓂ 8050-1060 ⓂⓂⓂ 26-1198Sport				
<b>E-Class (W210)</b>									
	Sedan, excl. 4-Matic	06.95-02	STR.T	ⓂⓂⓂ 8050-1066	ⓂⓂⓂ 8050-1067				
	E200, E200K, E230, E200D, E200CDI, E220D, E220CDI		Sport	ⓂⓂⓂ 8041-1317Sport	ⓂⓂⓂ 8041-1318Sport				
			STR.T Kit Sport Kit			1120-7241 1140-7241	35 35	35 35	1,2,13,15 1,2,13,15,16
	E240, E280, E320, E420, E430		STR.T Kit Sport Kit			1120-7242 1140-7242	35 35	35 35	1,2,13,15 1,2,13,15,16
	E250D, E250TD, E270CDI, E290TD, E300D, E300TD, E320CDI		STR.T Kit Sport Kit			1120-7242 1140-7242	35 35	35 35	1,2,13,15 1,2,13,15,16
	Combi, excl. 4-Matic Avantgarde versions: KONI Sport only (1 click adjusted)	97-02	STR.T Sport	ⓂⓂⓂ 8050-1066 ⓂⓂⓂ 8041-1317Sport					
<b>E-Class (W211)</b>									
	Sedan Classic, Elegance excl. 4Matic (4WD), excl. air suspension	05.02-09	Sport	ⓂⓂⓂ 8041-1307Sport	ⓂⓂⓂ 8041-1308Sport				
	E200K, E230, E240, E200CDI, E220CDI		Sport Kit			1140-3241	40	40	1,2,13,15,16
	E280, E320, E350, E250CDI, E270CDI, E280CDI, E320CDI		Sport Kit			1140-3242	40	40	1,2,13,15,16
	Sedan Avantgarde excl. 4Matic (4WD), excl. air suspension	05.02-09	Sport	ⓂⓂⓂ 8041-1307Sport	ⓂⓂⓂ 8041-1308Sport				
	E200K, E230, E240, E200CDI, E220CDI		Sport Kit			1140-3243	40	40	1,2,13,15,16
	E280, E320, E350, E250CDI, E270CDI, E280CDI, E320CDI		Sport Kit			1140-3244	40	40	1,2,13,15,16
<b>E-Class (W212)</b>									
	E-Class excl. Airmatic DC, HD suspension & 4-Matic	01.09-16	Special-Active	ⓂⓂⓂ 8745-1323	ⓂⓂⓂ 8045-1378				
			Sport	ⓂⓂⓂ 8741-1570Sport	ⓂⓂⓂ 8040-1428Sport				
			Sport Kit			I.D.			
	T-Combi (S212) excl. Airmatic DC, HD suspension excl. 4Matic (AWD)	01.09-16	Special-Active Sport	ⓂⓂⓂ 8745-1323 ⓂⓂⓂ 8741-1570Sport					
<b>S-Class (W108) (W109)</b>									
	Sedan / Coupé	66-72	Classic	ⓂⓂⓂ 80-1415	ⓂⓂⓂ 80-1416				
<b>S-Class (W116)</b>									
	S-Class, excl. 6.9-Liter	73-80	Classic	ⓂⓂⓂ 26-1157	ⓂⓂⓂ 30-1020				
<b>S-Class (W126) (C126)</b>									
	Sedan / Coupé	80-91	Classic	ⓂⓂⓂ 26-1157	ⓂⓂⓂ 30-1020				
<b>SL-Class (W113)</b>									
	230SL, 250SL, 280SL	63-71	Classic	ⓂⓂⓂ 80-1415	ⓂⓂⓂ 80-1416				
<b>SL-Class (R107)</b>									
	SL-Class	71-91	Classic	ⓂⓂⓂ 26-1019	ⓂⓂⓂ 30-1020				

MAKE	Model	Year	product range				Lowering up to ..mm		Notes	
							Front	Rear		
<b>MERCEDES-BENZ - CONTINUED</b>										
<b>SLK-Class (R170)</b>										
	SLK 200, 230 Kompressor, 320	97-02.04	Sport Sport Kit					1140-7691	30 30	1,2,13,16
<b>180, 180D, 190, 190D, 190B, 190DB</b>										
	180, 180D, 190, 190D, 190B, 190DB	56-62	Classic							
<b>219, 220, 220A, 220S</b>										
	219, 220, 220A, 220S	55-59	Classic							
<b>G-Series (W460) (W461) (W463)</b>										
	<b>G-Series (W460)</b> OE: Front: Lmax 632 mm, Rear: Lmax 585 mm RAID Dampers: fit vehicles with standard or raised suspension, Front Rear: 0 - 50 mm	79-90	easy Track							
			easy Track							
	<b>G-Series (W461)</b> OE: Front: Lmax 632 mm, Rear: Lmax 585 mm RAID Dampers: fit vehicles with standard or raised suspension, Front Rear: 0 - 50 mm OE: Front: Lmax 585 mm, Rear: Lmax 585 mm RAID Dampers: fit vehicles with raised suspension, Front: 30 - 50 mm Rear: 0 - 50 mm	90-18	easy Track							
			easy Track							
	<b>G-Series (W463)</b> OE: Front: Lmax 585 mm, Rear: Lmax 585 mm RAID Dampers: fit vehicles with raised suspension, Front: 30 - 50 mm Rear: 0 - 50 mm	90-18	easy Track							
			T RAID							
<b>Commercials</b>										
	L207D, L208D, L209D, L210D (601)	05.77-02.96	Special							
	L208, L210 (601)	05.77-02.96	Special							
	L307D, L308D, L309D, L310D (602)	04.77-02.96	Special							
	L308, L310 (602)	04.77-02.96	Special							
<b>Sprinter (W901) (W906)</b>										
	Sprinter (901-903) 2WD 4WD	01.95-05.06	Special							
	Sprinter (904) 4.6 T Twin wheel rear	02.96-05.06	Special							
	Sprinter (906) 3.5T 2WD	06.06-18	Special							
			Special-Active							
	Sprinter (906) 3.5T 4x4	02.08-18	Special							I.D.
	Sprinter (906) 5.0T 2WD	06.06-18	Special							
			Special-Active							
	Camper Adria/Carthago/Burstner/Dethleffs etc. 3.5T ACTIVE technology inside for superior comfort and handling	06.06-18	Special-Active							
	Camper Adria/Carthago/Burstner/Dethleffs etc. 5.0T ACTIVE technology inside for superior comfort and handling	06.06-18	Special-Active							
<b>V-Class (W638) (W639) (W447)</b>										
	Vito 108D, 110D, 112, 113, 114 Front: for Monroe OE struts only	03.97-07.03	Special							
	Vito, Viano 3.0, 3.2, 3.7, 2.0CDI, 2.2CDI, 3.0CDI excl. 4Matic (AWD)	09.03-13	Special							
	Viano V200, V230, V280, V200CDI, V220CDI, V230TD Front: for Monroe OE struts only	02.97-07.03	Special							
	<b>V-Class / Vito 109CDI, 111CDI, 114CDI, 116CDI, 119CDI</b> excl.: Advanced Agility Control, air suspension, D suspension, 4Matic, Self-leveling system 4Matic versions, excl. Advanced Agility Control	10.14-	Special							
			Special-Active							
			Special							
<b>X-Class (W470)</b>										
	X-Class (W470) 220D, 250D incl. 4-Matic	09.17-	easy Track T RAID							
<b>MERCURY</b>										
<b>Bobcat</b>										
	Bobcat Sedan & Runabout	75-80	Classic							
<b>Capri</b>										
	Capri Rear: with bushing length 36,5 mm	79-86	Classic							On request
<b>Cougar</b>										
	Cougar	67-70	Classic							
	Cougar, excl. XR-7 Rear: with bushing length 36,5 mm	80-82	Classic							On request
<b>Marquis</b>										
	Marquis Sedan / Wagon	83-85	Classic							On request
<b>MG</b>										
<b>MG-B</b>										
	MG-B as from chassis no. 132.924 - with chrome bumpers	67-75	Classic							
	MG-B as from chassisno. G N5 360301 (Europe-Version) - with rubber bumpers as from chassisno. G N5 360082 ( SA-Version) - with rubber bumpers	75-82	Classic							
			Classic							
	MG-B GT Coupé up to chassisno. G D5 E 361000	65-75	Classic							
	MG-B GT Coupé as from chassisno. G D5 E 361001	75-82	Classic							

MAKE		Year	product range				Lowering up to ..mm		Notes
Model							Front	Rear	
<b>MG - CONTINUED</b>									
<b>MG-C</b>									
	MG-C 6-cyl., incl. GT	67-69	Classic			⌘+ 80-1244SP1			
<b>MINI</b>									
<b>Mini Classic</b>									
	Mini 850, 1000, 1100, 1275GT & Cooper models excl. cars with lowered suspension	60-00	Classic	⌘□ 80-1675		⌘□ 80-1794			
			Sport	□ 80-1675Sport		□ 80-1794Sport			
	Mini 850, 1000, 1100, 1275GT & Cooper models with lowered suspension	63-70	Classic	⌘□ 80-1717		⌘□ 80-1795			
	Mini Countryman, Estate, Clubman Estate, Pickup	61-78	Classic	⌘□ 80-1675					
	Mini Traveller, Van, Moke	61-78	Classic	⌘□ 80-1675					
	Mini Innocenti 90L, 120L incl. De Tomaso	74-82	Classic	⌘□ 80-1675		⌘□ 80-1794			
			Sport	□ 80-1675Sport		□ 80-1794Sport			
<b>New Mini</b>									
	Mini One, Cooper (R50) Front: with anti-roll bar attached to spring seat	01-02.02	Special-Active			Ⓞ 8045-1232			
			STR.T			Ⓞ 8050-1100			
			Sport			⌘Ⓞ 8041-1293Sport			
	Mini One, Cooper (S), incl. Cabrio (R50, R52, R53) Front: with anti-roll bar attached to damper body	03.02-06	Special-Active	Ⓞ 8745-1012L Ⓞ 8745-1012R		Ⓞ 8045-1232			
			STR.T	Ⓞ▲ 8750-1078L Ⓞ▲ 8750-1078R		Ⓞ 8050-1100			
			Sport	⌘Ⓞ 8741-1440LSport ⌘Ⓞ 8741-1440RSport		⌘Ⓞ 8041-1293Sport			
			STR.T Kit				1120-3432	30	30
			Sport Kit				1140-3432	30	30
	Mini One, Cooper (S) incl. JCW & Cabrio (R56, R57)	11.05-11.13	Special-Active	Ⓞ 8745-1189L Ⓞ 8745-1189R		Ⓞ 8245-1190L Ⓞ 8245-1190R			
			Sport	⌘Ⓞ 8741-1512LSport ⌘Ⓞ 8741-1512RSport		⌘Ⓞ 8241-1252LSport ⌘Ⓞ 8241-1252RSport			
			Sport Kit				1140-0901	30	30
	Clubman One, Cooper (S/D/SD) incl. JCW (R55)	10.06-06.14	Special-Active	Ⓞ 8745-1189L Ⓞ 8745-1189R		Ⓞ 8245-1190L Ⓞ 8245-1190R			
			Sport	⌘Ⓞ 8741-1512LSport ⌘Ⓞ 8741-1512RSport		⌘Ⓞ 8241-1252LSport ⌘Ⓞ 8241-1252RSport			
			Sport Kit				1140-0902	35	35
	Coupé Cooper (S, SD) incl. JCW (R58)	12.10-05.15	Special-Active	Ⓞ 8745-1189L Ⓞ 8745-1189R		Ⓞ 8245-1190L Ⓞ 8245-1190R			
			Sport	⌘Ⓞ 8741-1512LSport ⌘Ⓞ 8741-1512RSport		⌘Ⓞ 8241-1252LSport ⌘Ⓞ 8241-1252RSport			
			Sport Kit				1140-0901	25-30	25-30
	Roadster Cooper (S, SD) incl. JCW (R59)	01.11-04.15	Special-Active	Ⓞ 8745-1189L Ⓞ 8745-1189R		Ⓞ 8245-1190L Ⓞ 8245-1190R			
			Sport	⌘Ⓞ 8741-1512LSport ⌘Ⓞ 8741-1512RSport		⌘Ⓞ 8241-1252LSport ⌘Ⓞ 8241-1252RSport			
			Sport Kit				1140-0901	25-30	25-30
	Mini One (D) / First, Cooper (S/D/SD), JCW (F56) Excl. VDC	04.13-19	Special-Active	Ⓞ 8745-1377L Ⓞ 8745-1377R		Ⓞ 8245-1376			
			Sport	⌘Ⓞ 8741-1590LSport ⌘Ⓞ 8741-1590RSport		Ⓞ 8240-1303Sport			
			Sport Kit				I.D.		
	Mini One (D) / First, Cooper (S/D/SD) (F55) Excl. VDC	09.13-19	Special-Active	Ⓞ 8745-1377L Ⓞ 8745-1377R		Ⓞ 8245-1376			
			Sport	⌘Ⓞ 8741-1590LSport ⌘Ⓞ 8741-1590RSport		Ⓞ 8240-1303Sport			
<b>MITSUBISHI</b>									
<b>Challenger</b>									
	Challenger	97-00	eavy Track	Ⓞ 30-1456		82-2138			
	Challenger	00-07	eavy Track	Ⓞ 30-1456		Ⓞ 30-1705			
	Challenger	08-14	eavy Track	Ⓞ 8240-1270					
<b>Colt</b>									
	Colt / Mirage 1.3, 1.6 (CA1A / CA4A / CJ1A / CJ4A) Front: for original struts only	92-03	Sport	⌘◆ 8610-1343Sport					
<b>Eclipse</b>									
	Eclipse Coupé (D22A) front wheel drive Front: for K B struts only	90-94	Sport	⌘Ⓞ◆ 8641-1231Sport					
	Eclipse Coupé (D27A) 4WD Front: for K B struts only	90-94	Sport	⌘Ⓞ◆ 8641-1231Sport					
	Eclipse Coupé / Spyder (D32) 2WD / 4WD	95-99	Sport	⌘Ⓞ 8041-1207Sport		⌘Ⓞ 8041-1208Sport			
	Eclipse Coupé / Spyder Front: for K B struts only	00-05	Sport	⌘Ⓞ◆ 8641-1231Sport		⌘Ⓞ 8041-1208Sport			
<b>L200</b>									
	L200 Pickup (L021P)	79-96	eavy Track			80-2458			
	L200 Double-Cab (4WD) types K22T, K24T, K32T, K33T, K34T	86-03	eavy Track	Ⓞ 30-1318		Ⓞ 30-1459			
	L200 (K74, K74T, K75T) 4WD	96-05	eavy Track	Ⓞ 30-1326		Ⓞ 30-1459			
	L200 4WD Fit vehicles with standard or raised suspension, Front Rear: 0 - 30 mm	06-15	eavy Track	Ⓞ 8240-1270		Ⓞ 8240-1271SP1			
			T RAID	88-5390		90-5458			



MAKE	Model	Year	product range				Lowering up to ..mm		Notes
							Front	Rear	
<b>MITSUBISHI - CONTINUED</b>									
	L200 (KL3T) 4WD Fit vehicles with standard or raised suspension, Front Rear: 0 - 30 mm	15-19	easy Track T RAID	Ⓒ 8240-1316 88-5396	Ⓒ 8240-1318 90-5458				
<b>L300</b>									
	L300 Bus / Van (L032P / L038P / L062P / L068P)	80-86	easy Track		80-1904				
	L300 Bus (L035G / L037G) 4WD	84-86	easy Track	Ⓒ 30-1318					
	L300 Bus, Van (P23 / P24 / P25) 4WD	87-03	easy Track	Ⓒ 30-1318					
	L300 Cab (L032P, L039P)	87-02	easy Track		80-1904				
<b>L400</b>									
	L400 Bus, Van (PA5)	95-03	easy Track	Ⓒ 30-1365					
<b>Lancer</b>									
	Lancer Sedan / Hatchback 1.3, 1.6, 2.0D types CB1, CB4, CB8, Front: OE struts only	93-95	Sport	Ⓒ◆ 8610-1343Sport					
	Lancer (CK1A / CK4A) 1.6 Front: for original struts only	96-02	Sport	Ⓒ◆ 8610-1343Sport					
	Lancer Hatchback/Sedan (CX/CY) incl. AWD, excl. EVO	07-16	Sport	ⒸⒸ 8741-1593LSport ⒸⒸ 8741-1593RSport	Ⓒ 8040-1432Sport				
<b>Pajero</b>									
	Pajero / Montero / Shogun Types L040G, L042G, L043G, L044G (s.w.b.) and types L047G, L048G, L049G Wagon	83-91	easy Track	Ⓒ 30-1318					
	Pajero / Montero / Shogun 2.5 TD Intercooler, 3.0i s.w.b. and l.w.b. types L144G, L149G and L141G, L146G (with coils springs rear)	89-91	easy Track	Ⓒ 30-1318	Ⓒ▲ 30-1408				
	Pajero / Montero / Shogun 2.5TD, 2.8TDi, 3.0-V6 s.w.b. and l.w.b. types V21 V41 V23 V43 and V24 V44, excl. Electr. Damper Control	91-09.99	easy Track	Ⓒ 30-1456	Ⓒ 30-1457				
	Pajero / Montero / Shogun V60 & V70-series V64, V65, V68 V74, V75, V78, excl. Pajero Montero Sport	10.99-08	easy Track T RAID	82-2505 90-5443	82-2506 88-5389				
	Pajero / Montero / Shogun V80 & V90-series	07-16	easy Track T RAID	82-2505 90-5443	82-2506 88-5389				
	Pajero Pinin (iO) (4WD) Front: for original APA-K B struts only - excl. K B OEM no. MR319792 MR455401	98-04	easy Track	Ⓒ◆▲ 8640-1459	Ⓒ▲ 8040-1321				
	Pajero / Montero Sport K94W K96W, 2.5 TD - 3.0 V6	10.99-07	easy Track	Ⓒ 30-1456	Ⓒ 30-1705				
	Pajero / Montero Sport	08-14	easy Track	Ⓒ 8240-1270					
<b>Triton</b>									
	Triton (MK) AWD	96-05	easy Track	Ⓒ 30-1456	Ⓒ 30-1459				
	Triton (ML) 4WD Fit vehicles with standard or raised suspension, Front Rear: 0 - 30 mm	06-15	easy Track T RAID	Ⓒ 8240-1270 88-5390	Ⓒ 8240-1271SP1 90-5458				
	Triton 4WD	15-	easy Track T RAID						I.D. I.D.
<b>MORGAN</b>									
<b>Morgan</b>									
	4/4, Plus 4, V8 Rear: excl. 4-seater models	61-05.91	Classic	Ⓒ+ 80-1021	Ⓒ+ 80-1573				
	4/4, Plus 4, V8 (with telescopic rear dampers) Rear: only if distance between top bottom attachments in full droop 265 mm - 290 mm	06.91-94	Classic	Ⓒ 80-1021	Ⓒ 80-2725				
<b>NISSAN</b>									
<b>Almera</b>									
	Almera Hatchback, Sedan (N16) made in UK Front: for original struts only	00-06	Sport	Ⓒ◆ 8610-1409Sport					
	Almera Sedan (N16) made in Japan Front: for original struts only	00-02.01	Sport	Ⓒ◆ 8610-1409Sport	80-2838Sport				
<b>King Cab</b>									
	King Cab 2WD (GD21, D22)	86-04	easy Track		Ⓒ 30-1343				
	King Cab 4WD (MD21, D22)	86-04	easy Track	Ⓒ 30-1342	Ⓒ 30-1343				
<b>Maxima</b>									
	Maxima QX, Cefiro (A32) Front: for original struts only	10.94-00	Sport	Ⓒ◆▲ 8641-1362Sport					
	Maxima QX, Cefiro (A33) Front: for original struts only	00-03	Sport	Ⓒ◆▲ 8641-1439Sport	M2ⒸⒸ▲ 8040-1297Sport				
<b>Micra</b>									
	Micra (K12) 1.0, 1.2, 1.4, 1.6, 1.5dCi excl. CC excl. Nissan March (Japan)	02.03-10	STR.T Sport		Ⓒ 8050-1123 Ⓒ▲ 8041-1355Sport				
<b>Navara</b>									
	Navara D21/D22 4WD with torsion bars front	86-04	easy Track	Ⓒ 30-1342	Ⓒ 30-1343				
	Navara D40 2.5DCi, 4.0 V6 Fit vehicles with standard or raised suspension, Front Rear: 0 - 30 mm	05-15	easy Track T RAID	82-2570 90-5450	82-2572SP1 90-5451				
	RAID Dampers: fit vehicles with standard or raised suspension, Front 0 - 20 mm Rear: 0 - 30 mm								
	Navara D23/NP300 Single (King) Cab 4x2/4x4 KONI with Comfort setting. Front is equipped with FSD technology. For standard or raised suspension, Front Rear: 0 - 20 mm	01.15-19	T-Active easy Track	Ⓒ 8245-1395	82-2634				FSD Tech Inside leaf springs rear
	fit vehicles with raised suspension, Front: 0 - 40 mm Rear: 0 - 50 mm		T RAID	90-5476	90-5477				leaf springs rear
	Navara D23/NP300 Double (Crew) Cab 4x2/4x4 KONI with Comfort setting. Front is equipped with FSD technology. For standard or raised suspension, Front Rear: 0 - 20 mm	01.15-19	T-Active easy Track	Ⓒ 8245-1395	82-2631				FSD Tech Inside coil springs rear

MAKE		Year	product range				Lowering up to ..mm		Notes
Model							Front	Rear	
<b>NISSAN - CONTINUED</b>									
fit vehicles with raised suspension, Front: 0 - 40 mm Rear: 0 - 40 mm			T RAID	90-5476	90-5478				coil springs rear
<b>Note</b>									
Note 1.4, 1.6, 1.5DCi		06-13	STR.T		Ⓒ 8050-1123				
<b>Pathfinder</b>									
Pathfinder (WD21)		86-95	eavy Track	Ⓒ 30-1365	Ⓒ 30-1372				
Pathfinder (R51) 2.5DCi, 4.0 V6		05-14	eavy Track	82-2570	82-2571				
<b>Patrol</b>									
Patrol (VG 60/61)		72-80	eavy Track						
Steering damper (not adjustable)			eavy Track	Ⓒ 026-1580					
Patrol / Safari GR/GQ (Y60) with coil springs rear		87-09-97	eavy Track	Ⓒ 30-1379	Ⓒ 30-1380				
Steering damper (not adjustable)			eavy Track	82-2347SP1	82-2348SP1				
For vehicles with raised suspension, Front: Rear: 0 - 50 mm			eavy Track	Ⓒ 026-1635					
			eavy Track	82-2347	82-2348				
			eavy Track	88-1686	88-1687				
			T RAID	90-5370SP1	90-5371SP1				
Patrol / Safari R (160 / 260) with leaf springs		04.89-02	eavy Track	Ⓒ 30-1379	Ⓒ 30-1372				
Patrol / Safari GR/GU (Y61) vehicles with electr. adj. anti-roll bar rear: RAID excluded		10.97-13	eavy Track	Ⓒ 30-1379	Ⓒ 30-1380				
For vehicles with raised suspension, Front: Rear: 0 - 50 mm			eavy Track	82-2347SP1	82-2348SP1				
			eavy Track	82-2347	82-2348				
			eavy Track	88-1686	88-1687				
			T RAID	90-5370SP1	90-5371SP1				
<b>Qashqai</b>									
Qashqai (J10) 2WD 4WD		07-13	Special-Active	Ⓒ 8745-1334L Ⓒ 8745-1334R	Ⓒ 8045-1335				
			eavy Track	Ⓒ▲ 87-2658L Ⓒ▲ 87-2658R	Ⓒ▲ 80-2907				
Qashqai (J11) 4x2 Rear: only for cars with torsion-beam rear suspension		14-19	Special-Active	Ⓒ 8745-1379L Ⓒ 8745-1379R	Ⓒ 8245-1378				
Qashqai (J11) 4x2 & 4x4 Rear: only for cars with multi-link suspension		14-19	Special-Active	Ⓒ 8745-1379L Ⓒ 8745-1379R	Ⓒ 8045-1335				
<b>Silvia</b>									
Silvia 200 SX (S13) Front: for original struts only, Rear: for K B only		89-94	Sport	ⒸⒹⒺ 8641-1364Sport	Ⓒ 8040-1081Sport				
Silvia 240 SX (S13) Front: for original struts only, Rear: for K B only		89-94	Sport	ⒸⒹⒺ 8641-1364Sport	Ⓒ 8040-1081Sport				
Silvia (S14) / 200 SX (S15) Front: for original struts only		95-02	Sport	ⒸⒹⒺ 8641-1364Sport	Ⓒ▲ 8040-1226Sport				
<b>Sunny</b>									
Sunny 1200 Station Wagon (VB110)		70-73	eavy Track		80-1904				
Sunny 120Y Station Wagon (VB210 / VLB210)		74-77	eavy Track		80-1904				
Sunny / Sentra (N16) made in Japan Front + Rear: for original struts only		00-04	Sport	ⒸⒹ 8610-1409Sport	80-2838Sport				
<b>Terrano</b>									
Terrano / Pathfinder Wagon (WD21)		87-93	eavy Track	Ⓒ 30-1365	Ⓒ 30-1372				
Terrano II 4-door models (R20)		02.93-04	eavy Track	Ⓒ 30-1588	Ⓒ 30-1372				
Terrano II 2-door models (R20)		02.93-04	eavy Track	Ⓒ 30-1365	Ⓒ 30-1372				
<b>X-Trail</b>									
X-Trail SUV For original nisia-Jecs ( 51 mm) struts only		01-06.07	eavy Track	ⒸⒹⒺ▲ 8641-1451Sport	ⒸⒹⒺ▲ 8641-1452Sport				
X-Trail II SUV		07.07-10.13	Special-Active	Ⓒ 8745-1334L Ⓒ 8745-1334R	Ⓒ 8045-1335				
			eavy Track	Ⓒ▲ 87-2658L Ⓒ▲ 87-2658R	Ⓒ▲ 80-2907				
<b>Z-Series</b>									
Coupé 240 Z / Fairlady		70-75	Classic	Ⓒ 86-1811	Ⓒ 86-1812				On request
Coupé 260 Z / Fairlady (S30 / PS30) up to chassisno. RLS 30-060000		70-74	Classic	Ⓒ 86-1811	Ⓒ 86-1812				On request
Coupé 300 ZX / Fairlady, incl. Turbo (Z31) excl. electronically adjustable suspension		84-89	Sport	ⒸⒹ 8641-1060Sport	Ⓒ 26-1248Sport				
Coupé 300 ZX / Fairlady, incl. Turbo (Z32) disarms electronic suspension		89-96	Sport	ⒸⒹ 8041-1118Sport	Ⓒ 8040-1119Sport				
350Z (Fairlady Z) 3.5 V6 Coupe & Roadster (Z33)		03-09	Sport	M1ⒸⒹⒺⒸ 8241-1216LSport M1ⒸⒹⒺⒸ 8241-1216RSport	ⒸⒹ 8241-1217Sport				
370Z (Fairlady Z) 3.7 V6 Coupe & Roadster (Z34)		09-19	Sport	ⒸⒹ 8241-1282LSport ⒸⒹ 8241-1282RSport	ⒸⒹ 8241-1283Sport				
			Sport Kit			1140-2331	30	30	1,2,13,16 Rear: on request
			Sport Kit			1140-9649	30	30	1,2,13,16
<b>NISSAN AUSTRALIA</b>									
<b>160 - 180 - 200</b>									
1600 Sedan (510)		68-72	Classic	Ⓒ 86-2224	Ⓒ 80-2299				
Sedan 160B, 180B (610)		72-77	Classic	Ⓒ 86-2224	Ⓒ 80-2299				
Sedan 200B (810)		77-81	Classic	Ⓒ 86-2224					
<b>Skyline</b>									
Sedan / Coupé (C210 + R30)		78-85	Classic	Ⓒ 86-2224					
Skyline (HR33) Rear: with eye attachment on the bottom		95-98	Sport	ⒸⒹ 8041-1338Sport					

MAKE		Year	product range				Lowering up to ..mm		Notes
Model							Front	Rear	
<b>NISSAN AUSTRALIA - CONTINUED</b>									
	Rear: with -bracket attachment on the bottom		Sport	ⓂⓈ 8041-1338Sport	ⓂⓈ 8041-1339Sport				on request
	<b>Skyline (HR34)</b> Rear: with eye attachment on the bottom	99-04	Sport	ⓂⓈ 8041-1338Sport					on request
	Rear: with -bracket attachment on the bottom		Sport	ⓂⓈ 8041-1338Sport	ⓂⓈ 8041-1339Sport				on request
<b>OLDSMOBILE</b>									
<b>88</b>									
	<b>88 Delta Royale, 98 Regency</b>	77-85	Classic	ⓂⓈ 8040-1087	ⓂⓈ 8040-1088				
<b>Custom</b>									
	<b>Custom Cruiser</b>	77-93	Classic	ⓂⓈ 8040-1087	ⓂⓈ 8040-1088				
<b>F 85</b>									
	<b>F 85-442, Cutlass Supreme</b>	64-67	Classic		ⓂⓈ 8040-1088				
	<b>Sedan</b>	68-77	Classic	ⓂⓈ 8040-1087	ⓂⓈ 8040-1088				
<b>OPEL</b>									
<b>Ascona</b>									
	<b>Ascona A Sedan / Voyage &amp; Caravan</b>	70-75	STR.T		Ⓢ 8250-1013				
			Sport	82-1739Sport	□ 82-1801Sport				
	<b>Ascona B</b>	76-81	Classic	ⓂⓈ 80-2275					
			STR.T	Ⓢ 8250-1014	Ⓢ 8250-1013				
			Sport	□ 82-1886Sport	□ 82-1801Sport				
			Sport Short	□ 82-2085Sport	□ 82-1668SPD1				Lmax -40 mm
<b>Agila</b>									
	<b>1.0, 1.2, 1.3 CDTi</b>	09.07-14	STR.T	Ⓢ 8750-1092L Ⓢ 8750-1092R	Ⓢ 8050-1125				
			STR.T Kit			1120-1601	30	30	1,2,13
<b>Astra</b>									
	<b>Astra F Sedan / Hatchback</b>	10.91-97	STR.T	Ⓢ 8650-1004	Ⓢ 8050-1030				
			Sport	ⓂⓈ 8610-1283Sport	ⓂⓈ 8010-1032Sport				
	<b>Astra F Sedan/Hatchback/Cabrio incl. 2.0GSI 16V</b>	10.91-97	STR.T	Ⓢ 8650-1004	Ⓢ 8050-1030				
			Sport	ⓂⓈ 8610-1283Sport	ⓂⓈ 8010-1032Sport				
	<b>Astra F Caravan, incl. -16V</b>	10.91-97	STR.T	Ⓢ 8650-1004					
	<b>Astra G Sedan, Hatchback</b>	03.98-04.04	STR.T	Ⓢ 8750-1028L Ⓢ 8750-1028R	Ⓢ 8050-1048				
			Sport	ⓂⓈ▲ 8710-1369LSport ⓂⓈ▲ 8710-1369RSport	80-2796Sport				
	Front axle load up to 885 kg		STR.T Kit			1120-5301	30	30	1,2,13
			Sport Kit			1140-5301	30	30	1,2,13,17,26
	Front axle load as from 886 kg		STR.T Kit			1120-5302	30	30	1,2,13
			Sport Kit			1140-5302	30	30	1,2,13,17,26
	<b>Astra G Caravan</b> excl. self-levelling systems	03.98-10.04	STR.T	Ⓢ 8750-1028L Ⓢ 8750-1028R	Ⓢ 8050-1084				
			Sport	ⓂⓈ▲ 8710-1369LSport ⓂⓈ▲ 8710-1369RSport					
	Front axle load up to 885 kg, excl. self-levelling systems		STR.T Kit			1120-4961	30	30	1,2,13,15
	Front axle load as from 886 kg, excl. self-levelling systems		STR.T Kit			1120-4962	30	30	1,2,13,15
	<b>Astra G Coupé 1.8-16V, 2.0-16V T, 2.2-16V, 2.2DTI</b>	03.00-04	STR.T	Ⓢ 8750-1028L Ⓢ 8750-1028R	Ⓢ 8050-1048				
			Sport	ⓂⓈ▲ 8710-1369LSport ⓂⓈ▲ 8710-1369RSport	80-2796Sport				
	Front axle load up to 885 kg		STR.T Kit			1120-5301	30	30	1,2,13
			Sport Kit			1140-5301	30	30	1,2,13,17,26
	Front axle load as from 886 kg		STR.T Kit			1120-5302	30	30	1,2,13
			Sport Kit			1140-5302	30	30	1,2,13,17,26
	<b>Astra G Cabrio 1.6-16V,1.8-16V,2.0T,2.2-16V,2.2DTI</b>	03.00-04	STR.T	Ⓢ 8750-1028L Ⓢ 8750-1028R	Ⓢ 8050-1048				
			Sport	ⓂⓈ▲ 8710-1369LSport ⓂⓈ▲ 8710-1369RSport	80-2796Sport				
	Front axle load up to 885 kg		STR.T Kit			1120-5301	30	30	1,2,13
			Sport Kit			1140-5301	30	30	1,2,13,17,26
	Front axle load as from 886 kg		STR.T Kit			1120-5302	30	30	1,2,13
			Sport Kit			1140-5302	30	30	1,2,13,17,26
	<b>Astra G OPC 2.0-16V</b>	00-03	STR.T	Ⓢ 8750-1028L Ⓢ 8750-1028R	Ⓢ 8050-1048				
			Sport	ⓂⓈ▲ 8710-1369LSport ⓂⓈ▲ 8710-1369RSport	80-2796Sport				
	<b>Astra H Sedan / Hatchback</b> excl. IDS-Plus suspension	04.04-10.09	STR.T	Ⓢ 8750-1085L Ⓢ 8750-1085R	Ⓢ 8250-1025				
	Front axle load up to 960 kg		STR.T Kit			1120-2091	35	35	1,2,13
	Front axle load as from 961 kg		STR.T Kit			1120-2092	35	35	1,2,13
	<b>Astra H GTC incl TwinTop</b> excl. IDS-Plus suspension	03.05-09	STR.T	Ⓢ 8750-1085L Ⓢ 8750-1085R	Ⓢ 8250-1025				
	<b>Astra H GTC excl. TwinTop</b> Front axle load up to 960 kg	03.05-09	STR.T Kit			1120-1611	30	30	1, 2, 13
	Front axle load as from 961 kg		STR.T Kit			1120-1612	30	30	1, 2, 13
	<b>Astra H Wagon</b> excl. IDS-Plus suspension and self-levelling systems	04-10	STR.T	Ⓢ 8750-1085L Ⓢ 8750-1085R					

MAKE		Year	product range				Lowering up to ..mm		Notes
Model							Front	Rear	
<b>OPEL - CONTINUED</b>									
<b>Astra J Sedan, 5 doors Hatchback</b> excl. GTC, OPC, V R, IDS-Plus suspension and self-leveling systems	09-15	Sport	☞☞ 8741-1568LSport ☞☞ 8741-1568RSport	☞☞ 8240-1293Sport					
Except 2.0L Diesel		Sport Kit			1140-8976-1	35	40	1, 2, 13, 15, 17	
2.0L Diesel only		Sport Kit			1140-8976-2	35	40	1, 2, 13, 15, 17	
<b>Astra J Sports Tourer</b> excl. GTC, OPC, V R, IDS-Plus suspension and self-leveling systems	09-15	Sport	☞☞ 8741-1568LSport ☞☞ 8741-1568RSport	☞☞ 8240-1293Sport					
Except 2.0L Diesel		Sport Kit			1140-8976-3	40	40	1, 2, 13, 15, 17	
2.0L Diesel only		Sport Kit			1140-8976-4	40	40	1, 2, 13, 15, 17	
<b>Astra J GTC</b> excl. Flexride, OPC, V R	01.12-17	Sport	☞☞ 8741-1585LSport ☞☞ 8741-1585RSport	☞☞ 8240-1301Sport					
Front axle load up to 1180 kg		Sport Kit			1140-8861	30	30	1, 2, 13, 15, 17	
Front axle load as from 1181 kg		Sport Kit			1140-8862	30	30	1, 2, 13, 15, 17	
<b>Astra K Hatchback &amp; Sports Tourer</b>	16-	Sport							I.D.
<b>Calibra</b>									
<b>Calibra, incl. 16V, V6, Turbo 4WD</b>	90-98	Sport	☞ 8610-1263Sport	☞ 8210-1158Sport					
<b>Campo</b>									
<b>Brava Pickup / Crew Cab, TFS-series 4WD</b>	92-98	eavy Track	☞ 30-1365						
<b>Cascada</b>									
<b>Cascada</b> excl. Flexride	01.13-19	Sport	☞☞ 8741-1585LSport ☞☞ 8741-1585RSport	☞ 8240-1301Sport					
<b>Cascada</b> Front axle load up to 1160 kg	01.13-17	Sport Kit			1140-9986	30	30	1, 2, 13, 17	
Front axle load as from 1161 kg		Sport Kit			1140-9982	30	30	1, 2, 13, 17	
<b>Commodore</b>									
<b>Commodore A GS, GS-E</b>	67-71	Classic		☞ 80-1997					
<b>Commodore B</b>	76-77	STR.T		☞ 8250-1013					
		Sport		☐ 82-1801Sport					
<b>Combo</b>									
<b>Combo</b>	94-01	Sport	☞ 8710-1276Sport						
<b>Combo</b>	01-02.12	STR.T	☞ 8750-1034L ☞ 8750-1034R						
<b>Corsa</b>									
<b>Corsa A, incl. GSi</b>	83-93	STR.T	☞ 8750-1021						
		Sport	☞ 8710-1276Sport						
<b>Corsa B 1.0, 1.2, 1.4, 1.5D, 1.7D &amp; 1.6 GSi</b>	93-00	STR.T	☞ 8750-1021	☞ 8050-1027					
		Sport	☞ 8710-1276Sport						
<b>Corsa C</b>	10.00-06	STR.T	☞ 8750-1034L ☞ 8750-1034R	☞ 8050-1054					
front axle load up to 790 kg		STR.T Kit			1120-3761	30	30	1,2,13	
front axle load as from 791 kg		STR.T Kit			1120-3762	30	30	1,2,13	
<b>Corsa C GSI</b>	10.00-06	STR.T	☞ 8750-1034L ☞ 8750-1034R	☞ 8050-1054					
		STR.T Kit			1120-3762	30	30	1,2,13	
<b>Corsa D 1.0, 1.2, 1.4, 1.6T, 1.3CDTi, 1.7CDTi</b> excl. Ecoflex, Opel Sport Suspension and OPC	06-14	STR.T	☞ 8750-1093L ☞ 8750-1093R	☞ 8050-1111					
Front axle load up to 850Kg		STR.T Kit			1120-1313	30	30	1,2,13	
Front axle load as from 851 kg		STR.T Kit			1120-1314	30	30	1,2,13	
with Ecoflex, Opel Sport Suspension and OPC		STR.T	☞ 8750-1093L ☞ 8750-1093R	☞ 8050-1113					
		Sport		☞ 8040-1399Sport					
Front axle load up to 850Kg		STR.T Kit			1120-1311	30	30	1,2,13	
Front axle load as from 851 kg		STR.T Kit			1120-1312	30	30	1,2,13	
<b>Corsa D OPC</b>	06-14	STR.T	☞ 8750-1093L ☞ 8750-1093R	☞ 8050-1113					
		Sport		☞ 8040-1399Sport					
		STR.T Kit			1120-1312	30	30	1,2,13	
<b>Corsa E</b> excl. Ecoflex, Opel Sport Suspension and OPC	09.14-19	STR.T	☞ 8750-1093L ☞ 8750-1093R	☞ 8050-1111					
Front axle load up to 860 kg		STR.T Kit			1120-1313	20	20	1, 2, 13	
Front axle load as from 861 kg		STR.T Kit			1120-1314	20	20	1, 2, 13	
with Ecoflex, Opel Sport Suspension		STR.T	☞ 8750-1093L ☞ 8750-1093R	☞ 8050-1113					
		Sport		☞ 8040-1399Sport					
Front axle load up to 860 kg		STR.T Kit			1120-1311	20	20	1, 2, 13	
Front axle load as from 861 kg		STR.T Kit			1120-1312	20	20	1, 2, 13	
<b>Frontera</b>									
<b>Frontera 2-door</b> (with leaf springs rear)	91-95	eavy Track	☞ 30-1365						
<b>Frontera 4-door</b> (with leaf springs rear)	91-95	eavy Track	☞ 30-1365	☞ 30-1500					
<b>Frontera, incl. Sport</b> with coil springs rear	95-09.98	eavy Track	☞ 30-1565	☞ 30-1566					
<b>Frontera 2</b>	10.98-04	eavy Track	☞ 30-1663	☞ 30-1664					

MAKE	Model	Year	product range				Lowering up to ..mm		Notes
							Front	Rear	
<b>OPEL - CONTINUED</b>									
<b>GT</b>									
	GT	69-72	Classic	☞ 80-1580	☞ 80-1997				
			Sport	80-1580Sport	☐ 80-1997Sport				
<b>Insignia</b>									
	Insignia A (G09) excl. Tourer excl. OPC, excl. Flexride, excl. 4WD	08-02.17	Sport		Ⓞ▲ 8240-1291Sport				
<b>Kadett</b>									
	Kadett B Sedan / Coupé / Caravan as from chassisno. 1234068	09.67-73	Classic	☞ 80-1580	☞ 80-1997				
			Sport	80-1580Sport	☐ 80-1997Sport				
	Kadett C Sedan / Coupé / GTE	74-79	STR.T	Ⓞ 8250-1014					
			Sport	☐ 82-1886Sport	82-1740sport				Rear I.D.
			Sport Short	☐ 82-2085Sport	☐ 82-1668SPD1				Lmax -40 mm
	Kadett C Caravan	74-79	Classic	☞☐ 80-2275	☞ 80-1997				
	Kadett C City	75-79	Classic	☞☐ 80-2275	☞ 80-1997				
			STR.T	Ⓞ 8250-1014					
			Sport	☐ 82-1886Sport	☐ 80-1997Sport				
	Kadett D Hatchback	80-84	STR.T	Ⓞ 8650-1006					
	Kadett D Caravan	80-84	STR.T	Ⓞ 8650-1006					
	Kadett E Sedan / Hatchback, incl. GT	85-09.88	STR.T	Ⓞ 8650-1006					
	Kadett E Sedan / Hatchback, incl. GT, excl GSi	10.88-91	Sport	ⓄⓄ 8641-1068Sport	ⓄⓄ 8041-1095Sport				
	Kadett E Hatchback GSi, incl. 2.0i-16V	85-09.88	Sport	ⓄⓄ 8641-1068Sport					
	Kadett E Hatchback/Cabrio(>93) GSi incl. 2.0i-16V	10.88-91	Sport	ⓄⓄ 8641-1068Sport	ⓄⓄ 8041-1095Sport				
	Kadett E Caravan	85-91	STR.T	Ⓞ 8650-1006					
<b>Manta</b>									
	Manta A	70-75	Sport	82-1739Sport	82-1740sport				
	Manta B / CC incl. GT/E & GSi	76-88	Classic	☞☐ 80-2275					
			STR.T	Ⓞ 8250-1014	Ⓞ 8250-1013				
			Sport	☐ 82-1886Sport	☐ 82-1801Sport				
			Sport Short	☐ 82-2085Sport	☐ 82-1668SPD1				Lmax -40 mm
<b>Monterey</b>									
	Monterey	92-03.95	eavy Track	Ⓞ 30-1565	Ⓞ 30-1566				
	Monterey	04.95-98	eavy Track		Ⓞ 30-1566				
<b>Omega</b>									
	Omega A Sedan, excl. 3000	87-93	Sport		Ⓞ 80-2591Sport				
	Omega B Sedan 2.0, 2.0-16V, 2.2-16V, 2.0DTi excl. cars with RCS, Front: original struts only	94-03	Sport	Ⓞ◆ 8610-1315Sport	Ⓞ 80-2591Sport				
	Omega B Sedan 2.5TD, 2.5-V6, 3.0-V6, MV6 excl. cars with RCS, Front: original struts only	94-03	Sport	Ⓞ◆ 8610-1315Sport	Ⓞ 80-2591Sport				
	Omega B Caravan all, incl. V6, MV6 excl. cars with RCS, Front: original struts only	94-03	Sport	Ⓞ◆ 8610-1315Sport					
<b>Rekord</b>									
	Rekord D	76-77	STR.T		Ⓞ 8250-1013				
			Sport		☐ 82-1801Sport				
<b>Senator</b>									
	Senator 2.5i, 2.6i, 3.0i excl. electronically adjustable suspension	88-93	Sport		80-2591Sport				
<b>Signum</b>									
	Signum excl. IDS-Plus suspension and self-levelling systems	03-09.05	STR.T	Ⓞ 8750-1082L Ⓞ 8750-1082R	ⓄⓄ 8050-1104				
			Sport		ⓄⓄ 8040-1334Sport				
	Front axle load up to 1000 kg		STR.T Kit			1120-3193-1	40	40	1,2,13,15
	Front axle load as from 1001 kg		STR.T Kit			1120-3194-1	40	40	1,2,13,15
	Signum excl. IDS-Plus suspension and self-levelling systems	10.05-09	STR.T		ⓄⓄ 8050-1104				
			Sport		ⓄⓄ 8040-1334Sport				
<b>Tigra</b>									
	Tigra Front: Before fitting the dampers have to be adjusted one full turn	95-00	STR.T	Ⓞ 8750-1021	Ⓞ 8050-1027				
			Sport	Ⓞ 8710-1276Sport					
	Tigra TwinTop 1.4, 1.8, 1.3CDTi	04-09	STR.T	Ⓞ 8750-1034L Ⓞ 8750-1034R	Ⓞ 8050-1054				
			STR.T Kit			1120-3762	30	30	1,2,13
<b>Vectra</b>									
	Vectra A 1.4, 1.6, 1.7D/TD, 1.8, 2.0, 2.5-V6	88-95	Sport	Ⓞ 8610-1263Sport	ⓄⓄ 8041-1095Sport				
	Vectra A 1.8, 2.0 GL (4WD) with IRS (independant rear suspension)	89-95	Sport	Ⓞ 8610-1263Sport	80-2591Sport				
	Vectra A 2.0-16V Turbo 4WD	91-95	Sport	Ⓞ 8610-1263Sport	80-2591Sport				
	Vectra A 2000, incl. 4WD with IRS (independant rear suspension)	89-95	Sport	Ⓞ 8610-1263Sport	80-2591Sport				
	Vectra B Sedan	96-03.02	Special-Active		Ⓞ 8045-1160				
	Vectra B Caravan	96-03.02	Special-Active		ⓄⓄ 8045-1160				
	Vectra C Sedan excl. OPC, V R, IDS-Plus suspension and self-levelling systems	04.02-09.05	STR.T	Ⓞ 8750-1082L Ⓞ 8750-1082R	Ⓞ 8050-1104				
			Sport		Ⓞ 8040-1334Sport				
	Front axle load up to 1000 kg		STR.T Kit			1120-3191-1	40	40	1,2,13,15
	Front axle load as from 1001 kg		STR.T Kit			1120-3192-1	40	40	1,2,13,15
	Vectra C Sedan excl. OPC, V R, IDS-Plus suspension and self-levelling systems	10.05-09	STR.T		Ⓞ 8050-1104				
			Sport		Ⓞ 8040-1334Sport				

MAKE		Year	product range				Lowering up to ..mm		Notes
Model	Front						Rear		
<b>OPEL - CONTINUED</b>									
<b>Vectra C GTS</b> excl. OPC, V R, IDS-Plus suspension and self-levelling systems	04.02-09.05	STR.T	Ⓒ 8750-1082L Ⓒ 8750-1082R	Ⓒ 8050-1104					
		Sport		Ⓒ 8040-1334Sport					
		Front axle load up to 1000 kg	STR.T Kit			1120-3191-1	40	40	1,2,13,15
		Front axle load as from 1001 kg	STR.T Kit			1120-3192-1	40	40	1,2,13,15
<b>Vectra C GTS</b> excl. OPC, V R, IDS-Plus suspension and self-levelling systems	10.05-09	STR.T		Ⓒ 8050-1104					
		Sport		Ⓒ 8040-1334Sport					
<b>Vectra C Wagon</b> excl. OPC, V R, IDS-Plus suspension and self-levelling systems	04.02-09.05	STR.T	Ⓒ 8750-1082L Ⓒ 8750-1082R	Ⓝ Ⓒ 8050-1104					
		Sport		Ⓝ Ⓒ 8040-1334Sport					
		Front axle load up to 1000 kg	STR.T Kit			1120-3193-1	40	40	1,2,13,15
		Front axle load as from 1001 kg	STR.T Kit			1120-3194-1	40	40	1,2,13,15
<b>Vectra C Wagon</b> excl. OPC, V R, IDS-Plus suspension and self-levelling systems	10.05-09	STR.T		Ⓝ Ⓒ 8050-1104					
		Sport		Ⓝ Ⓒ 8040-1334Sport					
<b>Zafira</b>									
<b>Zafira A 1.6, 1.8, 2.2, 1.7 TD, 2.0 TD, 2.2 TD</b> excl. OPC	04.99-05	STR.T	Ⓒ 8750-1028L Ⓒ 8750-1028R	Ⓒ 8050-1084					
		Sport	Ⓜ ▲ 8710-1369LSport Ⓜ ▲ 8710-1369RSport						
<b>PEUGEOT</b>									
<b>106</b>									
<b>106</b> 1.0, 1.1, 1.3, 1.4, 1.6, 1.4D, 1.5D. Incl. SI, Rallye (limited lowering)	09.91-04.96	STR.T	Ⓒ 8650-1003	Ⓒ 8050-1020					
		Sport	86-2568Sport	Ⓒ 26-1481Sport					
		STR.T Kit			1120-8711	25	0	1,2,12,13	
		Sport Kit			1140-8711	25	0	1,2,12,13	
<b>106</b> 1.0, 1.1, 1.3, 1.4, 1.6, 1.4D, 1.5D. Incl. SI, Rallye (limited lowering)	05.96-06	STR.T	Ⓒ 8650-1003	Ⓒ 8050-1020					
		Sport	86-2568Sport	Ⓒ 26-1481Sport					
		STR.T Kit			1120-7571	45	0	1,2,12,13	
		Sport Kit			1140-7571	45	0	1,2,12,13	
<b>106 GTi 1.6 16V</b>	05.96-06	STR.T	Ⓒ 8650-1003	Ⓒ 8050-1020					
		Sport	86-2568Sport	Ⓒ 26-1481Sport					
		STR.T Kit			1120-7861	30	0	1,2,12,13	
		Sport Kit			1140-7861	30	0	1,2,12,13	
<b>107</b>									
<b>107 1.0, 1.4HDi</b>	05-15	STR.T	Ⓒ 8750-1090L Ⓒ 8750-1090R	Ⓒ 8050-1110					
		STR.T Kit			1120-1541	35	35	1,2,13	
<b>108</b>									
<b>108</b>	05.14-19	STR.T	Ⓒ 8750-1090L Ⓒ 8750-1090R	Ⓒ 8050-1110					
		STR.T Kit			1120-1541	40	25	1, 2, 13	
<b>205</b>									
<b>205, 1.0, 1.1</b>	83-98	STR.T	Ⓒ 8750-1016L Ⓒ 8750-1016R	Ⓒ 8050-1022					
		Sport	87-5085LSport 87-5085RSport	Ⓒ 30-1314Sport					
<b>205, incl. Cabrio</b>	83-98	STR.T	Ⓒ 8750-1016L Ⓒ 8750-1016R	Ⓒ 8050-1022					
		Sport	87-5085LSport 87-5085RSport	Ⓒ 30-1314Sport					
<b>205 GTi, Rallye</b>	84-94	STR.T	Ⓒ 8750-1016L Ⓒ 8750-1016R	Ⓒ 8050-1022					
		Sport	87-5085LSport 87-5085RSport	Ⓒ 30-1314Sport					
<b>205 Turbo Diesel</b>	91-96	STR.T	Ⓒ 8750-1016L Ⓒ 8750-1016R	Ⓒ 8050-1022					
		Sport	87-5085LSport 87-5085RSport	Ⓒ 30-1314Sport					
<b>206</b>									
<b>206</b> 1.1, 1.4 (16V), 1.6 (16V), 1.4 DI, 1.6 DI, 1.9, 2.0 DI	98-06	STR.T	Ⓒ 8750-1015L Ⓒ 8750-1015R	Ⓒ 8050-1023					
		Sport	Ⓜ 8710-1372LSport Ⓜ 8710-1372RSport	Ⓒ 26-1653Sport					
		STR.T Kit			1120-4691	30-35	0	1,2,12,13	
		Sport Kit			1140-4691	30-35	0	1,2,12,13,17	
<b>206 GTi</b>	98-06	STR.T	Ⓒ 8750-1015L Ⓒ 8750-1015R	Ⓒ 8050-1023					
		Sport	Ⓜ 8710-1372LSport Ⓜ 8710-1372RSport	Ⓒ 26-1653Sport					
		STR.T Kit			1120-4691	30-35	0	1,2,12,13	
		Sport Kit			1140-4691	30-35	0	1,2,12,13,17	

MAKE		Year	product range			Lowering up to ..mm		Notes
Model						Front	Rear	
<b>PEUGEOT - CONTINUED</b>								
206 RC	03-06	STR.T	Ⓒ 8750-1015L Ⓒ 8750-1015R	Ⓒ 8050-1023				
		Sport	8710-1372LSport 8710-1372RSport	Ⓒ 26-1653Sport				
		STR.T Kit			1120-4691	30-35	0	1,2,12,13
		Sport Kit			1140-4691	30-35	0	1,2,12,13,17
206 SW	06.02-06	STR.T	Ⓒ 8750-1015L Ⓒ 8750-1015R	Ⓒ 8050-1023				
		Sport	8710-1372LSport 8710-1372RSport	Ⓒ 26-1653Sport				
		STR.T Kit			1120-4691	30-35	0	1,2,12,13
		Sport Kit			1140-4691	30-35	0	1,2,12,13,17
206 CC	01.01-06	STR.T	Ⓒ 8750-1015L Ⓒ 8750-1015R	Ⓒ 8050-1023				
		Sport	8710-1372LSport 8710-1372RSport	Ⓒ 26-1653Sport				
		STR.T Kit			1120-4692	30-35	0	1,2,12,13
		Sport Kit			1140-4692	30-35	0	1,2,12,13,17
<b>206+</b>								
206+	06-13	STR.T	Ⓒ 8750-1015L Ⓒ 8750-1015R	Ⓒ 8050-1023				
		Sport	8710-1372LSport 8710-1372RSport	Ⓒ 26-1653Sport				
		STR.T Kit			1120-4691	30-35	0	1,2,12,13
		Sport Kit			1140-4691	30-35	0	1,2,12,13
<b>207</b>								
207 Hatchback 1.4, 1.4VTi, 1.4 HDi	06-14	STR.T	Ⓒ▲ 8750-1094L Ⓒ▲ 8750-1094R					
207 SW 1.4, 1.4VTi, 1.4 HDi excl. SW Outdoor	06-14	STR.T	Ⓒ▲ 8750-1094L Ⓒ▲ 8750-1094R					
<b>208</b>								
208 1.6e HDi, 1.6VTi 120Hp Front: for original struts 51 mm only	12-18	Sport	Ⓒ 8741-1555LSport Ⓒ 8741-1555RSport					
<b>306</b>								
306 1.1	03.93-06.02	STR.T	Ⓒ 8750-1014L Ⓒ 8750-1014R	Ⓒ 8050-1063				
		Sport	87-2601LSport 87-2601RSport	Ⓒ 26-1486Sport				
306 1.4, 1.6, 1.8, incl. Cabrio	03.93-06.02	STR.T	Ⓒ 8750-1014L Ⓒ 8750-1014R	Ⓒ 8050-1063				
		Sport	87-2601LSport 87-2601RSport	Ⓒ 26-1486Sport				
306 1.9D/TD, 2.0HDi, 2.0/-16V, incl. Cabrio front axle load up to 950 kg	03.93-06.02	Sport	87-2601LSport 87-2601RSport	Ⓒ 26-1487Sport				
306 XSi, GTi, S16	03.93-06.02	STR.T	Ⓒ 8750-1014L Ⓒ 8750-1014R					
		Sport	87-2601LSport 87-2601RSport	Ⓒ 26-1487Sport				
306 Break front axle load up to 950 kg	97-06.02	Sport	87-2601LSport 87-2601RSport	Ⓒ 26-1487Sport				
<b>307</b>								
307 Hatchback, Sedan	00-07	STR.T	Ⓒ 8750-1018	Ⓒ 8250-1003				
		Sport		Ⓒ 8240-1205Sport				
		STR.T Kit			1120-3472	35	35	1,2,13
		STR.T Kit			1120-3471	35	35	1,2,13
2.0 16V, 2.0 DI		STR.T Kit			1120-3041	35	15	1,2,13
2.0 16V 130 kW (177 hp)		STR.T Kit						
307 Break, SW	02-07	STR.T	Ⓒ 8750-1018	Ⓒ 8250-1003				
		Sport		Ⓒ 8240-1205Sport				
		STR.T Kit			1120-3042	35	15	1,2,13,15
1.4 (16V), 1.6 16V, 1.4 DI, 1.6 DI		STR.T Kit			1120-3041	35	15	1,2,13,15
2.0 16V, 2.0 DI		STR.T Kit						
307 CC	03-07	STR.T	Ⓒ 8750-1018	Ⓒ 8250-1003				
		Sport		Ⓒ 8240-1205Sport				
		STR.T Kit			1120-3042	35	15	1,2,13,15
1.6 16V		STR.T Kit			1120-3041	35	15	1,2,13,15
2.0 16V, 2.0 DI		STR.T Kit						
<b>308</b>								
308 Hatchback (T7) Front axle load as up to 1090 kg	07-13	Sport		Ⓒ 8240-1205Sport				
<b>309</b>								
309 GTD, 1.9GT with anti-roll bar rear	89-93	STR.T	Ⓒ 8750-1016L Ⓒ 8750-1016R	Ⓒ 8050-1022				
		Sport	87-5085LSport 87-5085RSport	Ⓒ 30-1314Sport				
309 GTi (incl. -16V)	87-93	STR.T	Ⓒ 8750-1016L Ⓒ 8750-1016R	Ⓒ 8050-1022				
		Sport	87-5085LSport 87-5085RSport	Ⓒ 30-1314Sport				

MAKE		Year	product range				Lowering up to ..mm		Notes
Model							Front	Rear	
<b>PEUGEOT - CONTINUED</b>									
<b>406</b>									
406 Sedan 1.8, 2.0, 1.9TD, 2.0Hdi, 2.1TD, 3.0-V6 Excl. electr. adjustable damper system. Front: OE spring seat has to be re-used	95-04	STR.T	Ⓒ 8750-1069L Ⓒ 8750-1069R	Ⓒ 8250-1020					
		Sport	ⒸⒹ 8741-1335LSport ⒸⒹ 8741-1335RSport	Ⓒ 8240-1155Sport					
406 Coupé Excl. electr. adjustable damper system. Front: OE spring seat has to be re-used	09.97-04	STR.T	Ⓒ 8750-1069L Ⓒ 8750-1069R	Ⓒ 8250-1020					
		Sport	ⒸⒹ 8741-1335LSport ⒸⒹ 8741-1335RSport	Ⓒ 8240-1155Sport					
406 Break Excl. electr. adjustable damper system. Front: OE spring seat has to be re-used	97-04	STR.T	Ⓒ 8750-1069L Ⓒ 8750-1069R						
		Sport	ⒸⒹ 8741-1335LSport ⒸⒹ 8741-1335RSport						
<b>PLYMOUTH</b>									
<b>Barracuda</b>									
Barracuda, 'Cuda rear lower shock mount hole 5 8ths inch	70-74	Classic	Ⓒ 80-1538	Ⓒ 82-1255					
<b>Belvedere</b>									
Belvedere, Satellite rear lower shock mount hole 5 8ths inch	62-72	Classic	Ⓒ 80-1538	Ⓒ 82-1255					
<b>Laser</b>									
Laser (4WD) Front: for original struts only	90-94	Sport	ⒸⒹⒺ 8641-1231Sport						
Laser (Front-wheel drive) Front: for original struts only	90-94	Sport	ⒸⒹⒺ 8641-1231Sport						
<b>Road Runner</b>									
Road Runner rear lower shock mount hole 5 8ths inch	68-72	Classic	Ⓒ 80-1538	Ⓒ 82-1255					
<b>Voyager</b>									
Voyager, Grand Voyager, excl. AWD Front: for original struts only	96-00	Special	ⒸⒹ 8640-1428						
<b>PONTIAC</b>									
<b>Bonneville</b>									
Bonneville, Catalina and Station Wagon	77-81	Classic	ⒸⒹ 8040-1087	ⒸⒹⒺ 8040-1088					
<b>Can-Am</b>									
Can-Am	77-77	Classic	ⒸⒹ 8040-1087	ⒸⒹⒺ 8040-1088					
<b>Firebird</b>									
Firebird	67-67	Classic	Ⓒ 80-1914	Ⓒ 80-1915					
Firebird	68-68	Classic	Ⓒ 80-1914	Ⓒ 80-1953					
Firebird	69-69	Classic	Ⓒ 80-1914						
Firebird, incl. Trans-Am	70-81	Classic	ⒸⒹ 8040-1017	ⒸⒹ 8040-1018					
Firebird, incl. Trans-Am with 16 inch tyres	82-92	Sport	ⒸⒹ 8741-1030Sport	Ⓒ 30-1265Sport					rear: on request
Firebird, incl. Trans-Am double adjustable alternative	93-02	Sport	N2ⒸⒹⒺ 8241-1139Sport	ⒸⒹ 8241-1140Sport					On request
		Sport		ⒸⒹⒺ 8242-1006SP1					
<b>Grand Prix</b>									
Grand Prix	69-70	Classic	ⒸⒹ 8040-1087	ⒸⒹⒺ 8040-1088					
Grand Prix, LJ, SJ	77-77	Classic	ⒸⒹ 8040-1087	ⒸⒹⒺ 8040-1088					
Grand-Am	73-77	Classic	ⒸⒹ 8040-1087	ⒸⒹⒺ 8040-1088					
<b>GTO</b>									
GTO Coupé Front: for original struts only	04-06	Sport	ⒸⒹⒺ 8641-1297Sport	ⒸⒹ 8041-1194Sport					
<b>Le Mans</b>									
Le Mans Station Wagon	68-72	Classic		ⒸⒹⒺ 8040-1088					
Le Mans, GTO	68-77	Classic	ⒸⒹ 8040-1087	ⒸⒹⒺ 8040-1088					
<b>Parisienne</b>									
Parisienne and Station Wagon	83-86	Classic	ⒸⒹ 8040-1087	ⒸⒹⒺ 8040-1088					
<b>Ventura</b>									
Ventura II with multi-leaf spring rear	71-74	Classic	ⒸⒹ 8040-1087	ⒸⒹⒺ 8040-1088					
<b>PORSCHE</b>									
<b>356</b>									
356 pre-A	49-50	Classic	Ⓒ 80-1013	△					
356 pre-A	51-55	Classic	Ⓒ 80-1013	Ⓒ 80-1011					
356 A, B, C incl. Super 90, 1600 Super	55-66	Classic	Ⓒ 80-1044SP20	Ⓒ 80-1191SP20					
Steering damper - Left hand drive only		Classic	Ⓒ 76-1099						
<b>911 (912)</b>									
911, 912 (A-series), incl. Targa Front: for original Boge struts only	09.65-08.68	Classic	Ⓒ 86-1394	ⒸⒹ 8040-1083					
		Classic	Ⓒ 86-1308	ⒸⒹ 8040-1083					
Front: if equipped with OEM KONI struts only		Classic	Ⓒ 86-1647	Ⓒ 80-2088					
911, 912 (B-series), T, S Front: for original Boge struts only	09.68-69	Classic	Ⓒ 86-1647	Ⓒ 80-2088					
		Classic	Ⓒ 86-1638	Ⓒ 80-2088					
Front: if equipped with OEM KONI struts only		Classic	Ⓒ 86-1647	Ⓒ 80-2088					
911 (C- and D-series), T, S Front: for original Boge struts only	70-08.71	Classic	Ⓒ 86-1647	Ⓒ 80-2088					
		Classic	Ⓒ 86-1638	Ⓒ 80-2088					
Front: if equipped with OEM KONI struts only		Classic	Ⓒ 86-1638	Ⓒ 80-2088					
911 (C- and D-series), E if originally equipped with self-levelling units front	69-08.71	Classic		Ⓒ 80-2088					



MAKE		Year	product range				Lowering up to ..mm		Notes
Model							Front	Rear	
<b>PORSCHE - CONTINUED</b>									
911 (E- and F-series), S, Carrera RS Front: for original Boge struts only	09.71-74	Classic	⌄ 86-1647	⌄ 82-1756					
		Classic	⌄ 86-1638	⌄ 82-1756					
		Classic		⌄ 82-1756					
911 (G-series) Carrera, Turbo Front: for original Boge struts only	75-89	Classic	⌄ 86-1943	⌄ □ 82-1962					
		Sport	⌄ 8641-1039Sport	⌄ 8210-1159Sport					
		Classic	⌄ 86-1942	⌄ □ 82-1962					
911 (964) Carrera 2+4 Coupé, Targa & Convertible	12.88-12.90	Special-Active	⌄ 8745-1250L ⌄ 8745-1250R						
		Sport	⌄ 8741-1541LSport ⌄ 8741-1541RSport						
911 (964) Carrera 2+4 Coupé, Targa & Convertible	01.91-09.93	Special-Active	⌄ 8745-1250L ⌄ 8745-1250R	⌄ 8245-1251					
		Sport	⌄ 8741-1541LSport ⌄ 8741-1541RSport	⌄ 8241-1272Sport					
		Sport Kit			1140-8131	40	40	1,2,13,16,21,22	
911 (964) Turbo (S)	08.90-09.93	Special-Active	⌄ 8745-1250L ⌄ 8745-1250R	⌄ 8245-1251					
		Sport	⌄ 8741-1541LSport ⌄ 8741-1541RSport	⌄ 8241-1272Sport					
		Sport Kit			1140-8341	35	35	1,2,13,16,21,22	
911 (964) Carrera RS	06.91-09.93	Sport	⌄ 8741-1541LSport ⌄ 8741-1541RSport						
911 (993) Carrera 2 (S) Coupé, Targa, Convertible excl. Bilstein OEM Sport Susp.	10.93-09.97	Special-Active	⌄ 8745-1252L ⌄ 8745-1252R	⌄ 8245-1253L ⌄ 8245-1253R					
		Sport	⌄ 8741-1542LSport ⌄ 8741-1542RSport	⌄ 8241-1273LSport ⌄ 8241-1273RSport					
		Sport Kit			1140-9531	30	30	1,2,13,16,21	
911 (993) Carrera 4 (S) Coupé, Targa, Convertible excl. Bilstein OEM Sport Susp.	10.93-09.97	Special-Active	⌄ 8745-1252L ⌄ 8745-1252R	⌄ 8245-1253L ⌄ 8245-1253R					
		Sport	⌄ 8741-1542LSport ⌄ 8741-1542RSport	⌄ 8241-1273LSport ⌄ 8241-1273RSport					
		Sport Kit			1140-9531	30	30	1,2,13,16,21	
911 (993) Turbo excl. Bilstein OEM Sport Susp.	03.95-09.97	Special-Active	⌄ 8745-1252L ⌄ 8745-1252R	⌄ 8245-1253L ⌄ 8245-1253R					
		Sport	⌄ 8741-1542LSport ⌄ 8741-1542RSport	⌄ 8241-1273LSport ⌄ 8241-1273RSport					
		Sport Kit			1140-5981	25	25	1,2,13,16,21	
911 (996) Carrera 2 (S) Coupé Excl. GT2, GT3, excl. PASM	09.97-08.05	Special-Active	⌄ 8745-1254	⌄ 8245-1255					
		Sport	⌄ 8741-1543Sport	⌄ 8241-1274Sport					
		Sport Kit			1140-5131	30	30	1,2,13,16	
911 (996) Carrera 2 (S) Targa, Convertible Excl. GT2, GT3, excl. PASM	09.97-08.05	Special-Active	⌄ 8745-1254	⌄ 8245-1255					
		Sport	⌄ 8741-1543Sport	⌄ 8241-1274Sport					
		Sport Kit			1140-5132	30	30	1,2,13,16	
911 (996) Carrera 4 (S) Coupé, Convertible Excl. GT2, GT3, excl. PASM	09.97-08.05	Special-Active		⌄ 8245-1255					
911 (996) Turbo (S) Coupé, Convertible Excl. GT2, GT3, excl. PASM	06.00-08.05	Special-Active		⌄ 8245-1255					
		Sport		⌄ 8241-1274Sport					
<b>914</b>									
914, 914-6	70-76	Sport	⌄ 8641-1077Sport	⌄ 8241-1050Sport					
<b>924</b>									
924, 924 Turbo	75-08.84	Classic	⌄ 86-1980						
		Sport	⌄ 8641-1038Sport	⌄ 26-1209Sport					
924 Carrera GT	81-81	Classic	⌄ 86-1980						
		Sport	⌄ 8641-1038Sport	⌄ 26-1209Sport					
924 S	09.84-87	Classic	⌄ 86-1980						
		Sport	⌄ 8641-1038Sport	⌄ 8040-1035Sport					
<b>928</b>									
928, 928 S Front: only if originally equipped with BOGE, excl. BOGE dampers with adjustable spring seat	79-93	Classic	⌄ 8240-1085	⌄ 8240-1086					
<b>944</b>									
944	81-08.84	Classic	⌄ 86-1980						
		Sport	⌄ 8641-1038Sport	⌄ 26-1209Sport					
944	09.84-86	Classic	⌄ 86-1980						
		Sport	⌄ 8641-1038Sport	⌄ 8040-1035Sport					
944 Front: for original Sachs struts only	86-91	Sport	⌄ 8641-1414Sport	⌄ 8040-1035Sport					
944 Turbo, incl. Turbo S Front: for original Sachs struts only	85-89	Sport	⌄ 8641-1414Sport	⌄ 8040-1035Sport					
944 S2 Coupé / S2 Cabrio Front: for original Sachs struts only	88-91	Sport	⌄ 8641-1414Sport	⌄ 8040-1035Sport					
<b>968</b>									
968, excl. M030 Susp. Front: for original Sachs struts only	92-96	Sport	⌄ 8641-1414Sport	⌄ 8040-1035Sport					

MAKE	Model	Year	product range				Lowering up to ..mm		Notes
							Front	Rear	
<b>PORSCHE - CONTINUED</b>									
<b>Boxster</b>									
	<b>Boxster (986), incl. Boxster S</b> excl. electronically adjustable suspension	96-04	Special-Active	Ⓒ 8745-1328	Ⓒ 8745-1329				
			Sport	ⒸⒹ 8741-1573Sport	Ⓒ 8740-1574Sport				
			Sport Kit			1140-7791	30	30	1, 2, 13, 17
	<b>Boxster (987), incl. Boxster S</b> excl. electronically adjustable suspension	11.04-12	Sport	I.D.	I.D.				I.D.
			Sport Kit						I.D.
<b>Cayman</b>									
	<b>Cayman (987) 2.7, 2.9, 3.4, 3.4 Sport incl 'S'</b> excl. electronically adjustable suspension	11.05-12.13	Sport		I.D.				
			Sport Kit						I.D.
<b>PROTON</b>									
<b>Satria</b>									
	<b>Satria</b> Front: for original struts only	96-05	Sport	ⒸⒹ 8610-1343Sport					
<b>RENAULT</b>									
<b>Alaskan</b>									
	<b>Alaskan 2.3 dCi incl 4x4</b>	09.17-	heavy Track		I.D.				I.D.
<b>Alpine</b>									
	<b>Alpine A108 / A110</b> Rear: 4 pieces	-75	Classic	Ⓒ 80-1743SP3	Ⓒ 80-1744SP3				
<b>Avantime</b>									
	<b>Avantime</b>	01-03	Special		Ⓒ 26-1647				
<b>Clio</b>									
	<b>Clio 1.8i-16V</b>	91-07.97	Sport	ⒸⒹ 8710-1301Sport					
	<b>Clio 2 1.2 incl. Campus / Accès models</b> Front: only if distance between centers of the two mounting bolts in bracket 52mm	98-12	Sport		Ⓒ 8010-1048Sport				
	Front: only if distance between centers of the two mounting bolts in bracket 58mm		STR.T	Ⓒ 8750-1023	Ⓒ 8050-1040				
			Sport		ⒸⒹ 8010-1048Sport				
	<b>Clio 2 1.4, 1.6, 1.6-16V, 1.5dCi, 1.9D, 1.9dTi</b> Front axle load up to 860 kg	98-12	STR.T	Ⓒ 8750-1023	Ⓒ 8050-1040				
			Sport		ⒸⒹ 8010-1048Sport				
	<b>Clio 2 Sport 2.0 16V 172 Hp Phase I &amp; II excl. Cup</b>	99-01.04	STR.T		Ⓒ 8050-1040				
			Sport	ⒸⒹ 8710-1395Sport	ⒸⒹ 8010-1048Sport				
	<b>Clio 2 Sport 2.0 16V 182 Hp Phase II&amp;III excl. Cup</b>	01.04-06	STR.T	Ⓒ 8750-1064	Ⓒ 8050-1040				
			Sport	ⒸⒹ 8710-1450Sport	ⒸⒹ 8010-1048Sport				
	<b>Clio 3</b> incl. GT, excl. 2.0 RS	05-12	STR.T	Ⓒ 8750-1091	Ⓒ 8050-1123				
	1.2 16V, 1.2 16V TCE		Sport		ⒸⒹ▲ 8041-1355Sport	1120-1401	45	45	1,2,13
	1.4 16V, 1.6 16V, 1.5dCi		STR.T Kit			1120-1402	45	45	1,2,13
	<b>Clio 3</b> 1.5 dCi 55 kW, 65 kW. Only for vehicles with front upper inner spring diameter 83 mm	08.10-12	STR.T Kit			1120-1406	45	45	1,2,13
	<b>Clio 3 GT</b> 1.6 16V	09-12	STR.T Kit			1120-1407	45	45	1,2,13
	<b>Clio 3 Estate</b>	02.08-12	STR.T	Ⓒ 8750-1091	Ⓒ 8050-1123				
	1.2 16V, 1.2 16V TCE		Sport		ⒸⒹ▲ 8041-1355Sport				
	1.4 16V, 1.6 16V, 1.5dCi		STR.T Kit			1120-1404	45	45	1,2,13
			STR.T Kit			1120-1405	45	45	1,2,13
	<b>Clio 3 2.0 RS</b> incl. F1 Team, excl. Cup	06-08.10	Sport	ⒸⒹ 8741-1533Sport	ⒸⒹ 8041-1389Sport				
			Sport Kit			1140-1031	30	30	1,2,13,16
	<b>Clio 3 2.0 RS (Phase II)</b> Incl. F1 Team, excl. Cup. Only for vehicles with front upper inner spring diameter 83 mm	09.10-12	Sport	ⒸⒹ 8741-1533Sport	ⒸⒹ 8041-1389Sport				
			Sport Kit			1140-1032	30	30	1, 2, 13, 16
	<b>Clio 4</b> excl. GT, RS	13-18	STR.T	Ⓒ 8750-1110	Ⓒ 8050-1139				
			STR.T Kit			1120-8839-1	30	30	1, 2, 13
	<b>Clio 4 Estate</b> excl. GT, RS	13-18	STR.T	Ⓒ 8750-1110	Ⓒ 8050-1139				
<b>Espace</b>									
	<b>Espace / Grand Espace (JEO)</b>	97-02	Special		Ⓒ 26-1647				
<b>Kadjar</b>									
	<b>Kadjar 4x2</b> Rear: only for cars with torsion-beam rear suspension	15-19	Special-Active	Ⓒ 8745-1379L Ⓒ 8745-1379R	Ⓒ 8245-1378				
	<b>Kadjar 4x2 &amp; 4x4</b> Rear: only for cars with multi-link suspension	15-19	Special-Active	Ⓒ 8745-1379L Ⓒ 8745-1379R	Ⓒ 8045-1335				
<b>Mégane</b>									
	<b>Mégane Sedan/Hatchback/Coupé/Cabrio, excl. 2.0-16V</b>	01.96-12.02	STR.T		Ⓒ 8050-1039				
	<b>Mégane Hatchback/ Coupé / Cabrio 2.0i, 2.0 IDE-16V</b>	0.96-12.02	STR.T		Ⓒ 8050-1039				
	<b>Mégane II Hatchback, Sedan, excl. RS</b>	10.02-09	STR.T	Ⓒ 8750-1035	Ⓒ 8050-1057				
			STR.T Kit			1120-5281	35-40	35-40	1,2,13
	<b>Mégane II Grand Tour, CC</b>	10.02-09	STR.T	Ⓒ 8750-1035	Ⓒ 8050-1057				
			STR.T Kit			1120-5282	35-40	35-40	1,2,13
	<b>Mégane II 2.0 RS / F1 Team R-26</b>	04-10.09	Sport	ⒸⒹ 8741-1533Sport	Ⓒ 8240-1260Sport				
			Sport Kit			1140-1901	25	25	1,2,13,17
<b>Modus</b>									
	<b>(Grand) Modus 1.2, 1.4, 1.6, 1.5DCi</b>	04-13	STR.T	Ⓒ 8750-1091	Ⓒ 8050-1123				
			Sport		ⒸⒹ▲ 8041-1355Sport				
<b>R5</b>									
	<b>R5 Super GTE (C 409)</b>	87-90	Sport		Ⓒ 26-1299Sport				
	<b>R5 Super GT-Turbo (C405) phase I</b> up to chassisno. F 02 7412 K 025 7635	85-06.87	Sport		Ⓒ 26-1299Sport				

MAKE		Year	product range				Lowering up to ..mm		Notes
Model							Front	Rear	
<b>RENAULT - CONTINUED</b>									
	R5 Super GT-Turbo (C405) phase II as from chassisno. F 02 7413 K 025 7636	07.87-90	Sport	ⓂⓄ 8741-1167Sport	Ⓞ 26-1299Sport				
<b>R8</b>									
	R8 Gordini (R1134 / R1135) Rear: 4 pieces	64-69	Classic	Ⓜ 80-1743SP3	Ⓜ 80-1744SP3				
<b>ROVER</b>									
<b>600 series</b>									
	618i, 620i, 620Si, 620GSi, 623Si, 620Di, 620Turbo	93-99	Sport	N3ⓂⓄⓄ 8041-1185LSport N3ⓂⓄⓄ 8041-1185RSport	R6+R7ⓂⓄⓄ 8041-1168SP4				
<b>SAAB</b>									
<b>9-3</b>									
	9-3, incl. Coupé, Cabrio incl. Viggen and Aero	03.98-09.02	Sport	ⓂⓄ 8641-1389Sport	ⓂⓄ 8041-1191Sport				
			Sport Kit			1140-4951	35	35	1,2,13,16
	9-3 Sport Sedan, incl. Aero	10.02-07	Special-Active	Ⓞ 8745-1010L Ⓞ 8745-1010R	Ⓞ 8245-1011				
			STR.T		Ⓞ 8050-1105				
			Sport	ⓂⓄ 8741-1479LSport ⓂⓄ 8741-1479RSport					
	9-3 Sport Sedan, incl. Aero excl. 4 wheel drive	08-11	Special-Active		Ⓞ 8245-1011				
			STR.T		Ⓞ 8050-1105				
			Sport	ⓂⓄ 8741-1539Sport					
	9-3 Sport Estate, incl. Aero	03.05-07	Special-Active	Ⓞ 8745-1010L Ⓞ 8745-1010R	Ⓞ 8245-1011				
			STR.T		Ⓞ 8050-1105				
			Sport	ⓂⓄ 8741-1479LSport ⓂⓄ 8741-1479RSport					
	9-3 Sport Estate, incl. Aero excl. 4 wheel drive	08-11	Special-Active		Ⓞ 8245-1011				
			STR.T		Ⓞ 8050-1105				
			Sport	ⓂⓄ 8741-1539Sport					
	9-3 Cabriolet	08.03-07	Special-Active	Ⓞ 8745-1010L Ⓞ 8745-1010R	Ⓞ 8245-1011				
			STR.T		Ⓞ 8050-1105				
			Sport	ⓂⓄ 8741-1479LSport ⓂⓄ 8741-1479RSport					
	9-3 Cabriolet	08-11	Special-Active		Ⓞ 8245-1011				
			STR.T		Ⓞ 8050-1105				
			Sport	ⓂⓄ 8741-1539Sport					
<b>9-5</b>									
	9-5 Sedan, incl. 3.0-V6 and Aero excl. self-levelling systems	97-08.01	Special-Active		Ⓞ 8045-1160				
			Sport	87-2622Sport					
	9-5 Sedan, incl. 3.0-V6 and Aero excl. self-levelling systems	09.01-04.10	Special-Active	Ⓞ 8745-1159	Ⓞ 8045-1160				
	9-5 Estate, incl. 3.0-V6 and Aero excl. self-levelling systems	97-08.01	Special-Active		Ⓞ 8045-1160				
			Sport	87-2622Sport					
	9-5 Estate, incl. 3.0-V6 and Aero excl. self-levelling systems	09.01-04.10	Special-Active	Ⓞ 8745-1159	Ⓞ 8045-1160				
<b>90</b>									
	90	85-87	Classic		ⓂⓄ 26-1087				
<b>99</b>									
	99, incl. Turbo	79-84	Classic		ⓂⓄ 26-1087				
<b>900</b>									
	900, incl. (16V) Turbo	78-93	Classic	ⓂⓄ 30-1088	ⓂⓄ 26-1087				
	900, 4- & 6-cyl.	93-98	Sport		ⓂⓄ 8041-1191Sport				
<b>9000</b>									
	9000 Front: for original Sachs struts only	85-98	Sport	ⓂⓄ 8641-1114Sport	Ⓞ 8040-1057Sport				
<b>SATURN</b>									
<b>LS / LW</b>									
	LS-1 / LS-2 / LW-1 / LW-2	00-05	Special-Active		Ⓞ 8045-1160				
<b>SCION</b>									
<b>Scion</b>									
	xA, xB	04-07	STR.T	Ⓞ 8750-1033	Ⓞ 8050-1053				
			Sport	Ⓜ 8710-1403Sport	80-2827Sport				
	tC Front: for original K B 49 mm struts only	05-08	Sport		▲ 80-2865Sport				
<b>FR-S</b>									
	FR-S	12-19	Sport	ⓂⓄ 8741-1560LSport ⓂⓄ 8741-1560RSport	ⓂⓄ 8041-1416Sport				
			Sport Kit			1140-8561	25	25	1,2,13,16
<b>SEAT</b>									
<b>124 Spider</b>									
	124	68-80	Sport	80-1877Sport	□ 80-1878Sport				
<b>Alhambra</b>									
	Alhambra (7N) 1.4 TSI, 2.0 TSI, 2.0 TDI incl. 4Motion, excl. DCC Suspension	10-19	Special-Active	Ⓞ 8745-1081	Ⓞ 8045-1085				
			Sport	ⓂⓄ 8741-1488Sport	Ⓞ 8040-1352Sport				
			Sport Kit			1140-9331	25	40	1,2,13,17

MAKE		Year	product range				Lowering up to ..mm		Notes
Model							Front	Rear	
<b>SEAT - CONTINUED</b>									
<b>Altea</b>									
Altea (5P), incl. XL, excl. Freetrack Front: for original struts 50 mm only	04-15	Special-Active		© 8045-1084					
		STR.T	© 8750-1006	© 8050-1006					
Front axle load up to 1020 kg		Sport	☞ 8710-1432Sport	80-2859Sport					
		STR.T Kit			1120-2613	35	35	1,2,13	
Front axle load as from 1021 kg		Sport Kit			1140-2614	35	35	1,2,13,17	
		STR.T Kit			1120-2614	35	35	1,2,13	
Front: for original struts 55 mm only		Sport Kit			1140-2614	35	35	1,2,13,17	
		Special-Active	© 8745-1006	© 8045-1084					
Front axle load up to 1020 kg		STR.T	© 8750-1005	© 8050-1006					
		Sport	☞ 8710-1431Sport	80-2859Sport					
Front axle load up to 1020 kg		STR.T Kit			1120-2611	35	35	1,2,13	
		Sport Kit			1140-2611	35	35	1,2,13,17	
Front axle load as from 1021 kg		Coil-over Kit			1150-5080-1	50	40	9,17,21,23 NO T V	
		STR.T Kit			1120-2612	35	35	1,2,13	
Front axle load as from 1021 kg		Sport Kit			1140-2612	35	35	1,2,13,17	
		Coil-over Kit			1150-5080-1	50	40	9,17,21,23 NO T V	
<b>Ateca</b>									
Ateca (KH7)	05-16-	Special-Active		I.D.	I.D.				
<b>Arona</b>									
Arona (KJ7)	07-17-	Special-Active		I.D.	I.D.				
<b>Arosa</b>									
Arosa	04.97-05	STR.T	© 8750-1001	© 8050-1002					
1.0, 1.4, 1.4 16V		STR.T Kit			1120-5291	30	30	1,2,13	
1.4 TDI, 1.7 SDI		STR.T Kit			1120-5292	30	30	1,2,13	
<b>Cordoba</b>									
Cordoba (6K)	08.93-08.99	STR.T	© 8750-1001	© 8050-1003					
1.0, 1.3, 1.4 (16V), 1.6		STR.T Kit			1120-9311	30	30	1,2,13	
1.8 16V, 2.0 8V, 1.9D, 1.9TD, 1.9SDI, 1.9TDI 66kW		STR.T Kit			1120-9312	30	30	1,2,13	
Cordoba (6K)	08.99-04.02	STR.T	© 8750-1001	© 8050-1003					
1.0, 1.4 (16V), 1.6		STR.T Kit			1120-9311	30	30	1,2,13	
		STR.T Kit			1120-9312	30	30	1,2,13	
Cordoba (6K) Coupé, incl. Cupra	96-02	STR.T	© 8750-1009						
Cordoba (6K) 1.9TDi (81 kW)	97-02	Sport	☞ 8741-1259Sport						
		STR.T	© 8750-1009						
Cordoba (6K) Vario 1.9 TDi (81 kW)	97-01	Sport	☞ 8741-1259Sport	© 8050-1003					
		STR.T Kit			1120-5212	30	30	1,2,13	
Cordoba (6L) 1.2, 1.4, 1.6, 1.4TDi, 1.6SDi, 1.9TDi	09.02-08	Special-Active	© 8745-1069	© 8045-1070					
Front axle load up to 830 kg		STR.T	© 8750-1004	© 8050-1005					
		Sport	☞ 8710-1404Sport	80-2830Sport					
Front axle load as from 831 kg		STR.T Kit			1120-2791	35	35	1,2,13	
		Sport Kit			1140-2791	35	35	1,2,13,17	
Cordoba (6L) Sport 1.9 TDi (96 kW) Front: Before fitting the dampers have to be adjusted one full turn	09.02-08	STR.T Kit			1120-2792	35	35	1,2,13	
		Sport Kit			1140-2792	35	35	1,2,13,17	
Cordoba (6L) Sport 1.9 TDi (96 kW) Front: Before fitting the dampers have to be adjusted one full turn		Sport	☞ 8710-1404Sport	80-2830Sport					
		Sport Kit			1140-2792	35	35	1,2,13,17	
<b>Exeo</b>									
Exeo (3R) Sedan & ST 1.6, 1.8T, 2.0 TSi, 2.0TDi	09-13	Special-Active	© 8245-1008	© 8045-1246					
Front axle load up to 1050 kg		STR.T	© 8250-1011	© 8050-1055					
		Sport	© 8240-1185Sport	© 8040-1283Sport					
Front axle load as from 1051 kg		STR.T Kit			1120-3691	35	35	1,2,13	
		Sport Kit			1140-3691	35	35	1,2,13	
Front axle load as from 1051 kg		STR.T Kit			1120-3692	35	35	1,2,13	
		Sport Kit			1140-3692	35	35	1,2,13	
<b>Ibiza</b>									
Ibiza (6K)	08.93-08.99	STR.T	© 8750-1001	© 8050-1003					
1.0, 1.3, 1.4 (16V), 1.6		STR.T Kit			1120-9311	30	30	1,2,13	
1.8 16V, 2.0 8V, 1.9D, 1.9TD, 1.9SDI, 1.9TDI 66kW		STR.T Kit			1120-9312	30	30	1,2,13	
Ibiza (6K) Cupra, GT TDI	97-08.99	STR.T	© 8750-1009						
Ibiza (6K)	08.99-04.02	Sport	☞ 8741-1259Sport						
		STR.T	© 8750-1001	© 8050-1003					
1.0, 1.4 (16V), 1.6		STR.T Kit			1120-9311	30	30	1,2,13	
1.9SDI, 1.9TDI 66kW		STR.T Kit			1120-9312	30	30	1,2,13	
Ibiza (6K) Cupra (excl. 'R')	08.99-04.02	STR.T	© 8750-1009						
Ibiza (6L) 1.2, 1.4, 1.6, 1.4TDi, 1.6SDi, 1.9TDi	04.02-08	Sport	☞ 8741-1259Sport						
		Special-Active	© 8745-1069	© 8045-1070					
Front axle load up to 830 kg		STR.T	© 8750-1004	© 8050-1005					
		Sport	☞ 8710-1404Sport	80-2830Sport					
Front axle load as from 831 kg		STR.T Kit			1120-3331	35	35	1,2,13	
		Sport Kit			1140-3331	35	35	1,2,13,17	
Front axle load as from 831 kg		STR.T Kit			1120-3332	35	35	1,2,13	
		Sport Kit			1140-3332	35	35	1,2,13,17	

MAKE	Model	Year	product range				Lowering up to ..mm		Notes	
							Front	Rear		
<b>SEAT - CONTINUED</b>										
	<b>Ibiza (6L) 1.9TDi (96kW) Signo &amp; Sport</b> KONI Sport (Kit), front: to be adjusted one full turn	04.02-04	Sport Sport Kit	☞ 8710-1404Sport	80-2830Sport	1140-3332	35	35	1,2,13,17	
	<b>Ibiza (6L) FR (1.8T &amp; TDi), Cupra (1.8T &amp; TDi)</b> KONI Sport (Kit), front: to be adjusted one full turn	04-08	Sport Sport Kit	☞ 8710-1404Sport	80-2830Sport	1140-3333	30-35	30-35	1,2,13,17	
	<b>Ibiza (6J/6P)</b> Incl. SC, FR, Cupra, Bocanegra excl. DCC	08-17	Special-Active STR.T Sport	☉ 8745-1278 ☉ 8750-1114 ☞ ☉ 8741-1548Sport	☉ 8045-1070 ☉ 8050-1005 80-2830Sport					
	Front axle load up to 860 kg		STR.T Kit Sport Kit			1120-0181 1140-0181	25	40	1,2,13 1,2,13,17	
	Front axle load as from 861 kg		STR.T Kit Sport Kit			1120-0182 1140-0182	25	40	1,2,13 1,2,13,17	
	<b>Ibiza (6J/6P) ST</b>		10-17	Special-Active STR.T Sport	☉ 8745-1278 ☉ 8750-1114 ☞ ☉ 8741-1548Sport	☉ 8045-1070 ☉ 8050-1005 80-2830Sport				
	Front axle load up to 860 kg	STR.T Kit Sport Kit				1120-0183 1140-0183	25	40	1,2,13 1,2,13,17	
	Front axle load as from 861 kg	STR.T Kit Sport Kit				1120-0184 1140-0184	25	40	1,2,13 1,2,13,17	
	<b>Ibiza (6F/KJ1)</b>	01.17-		Sport Sport Kit	I.D.	I.D.				I.D.
<b>Inca</b>										
	<b>Inca</b>	96-04	STR.T	☉ 8750-1001						
<b>Kodiaq</b>										
	<b>Kodiaq 2wd and 4x4, excl. Scout</b> excl. DCC (Dynamic Chassis Control)	10.16-19	Special-Active Sport	☉ 8745-1388 ☞ ☉ 8741-1572Sport	☉ 8245-1387 ☉ 8240-1311Sport					
<b>Leon</b>										
	<b>Leon (1M)</b> Incl. Cupra, FR Topsport 2WD, excl. Cupra R 4WD	99-05	Special Special-Active STR.T Sport	▲ 87-2571 ☉ 8745-1029 ☉ 8750-1002 ☞ 8710-1337Sport	▲ 80-2761 ☉ 8045-1083 ☉ 8050-1001 80-2761Sport					
	Front axle load up to 910 kg		STR.T Kit Sport Kit			1120-5261 1140-5261	35	35	1,2,13 1,2,13,17	
	Front axle load as from 911 kg		STR.T Kit Sport Kit			1120-5262 1140-5262	35	35	1,2,13 1,2,13,17	
	<b>Leon (1M), '4' 1.8T/2.8/1.9TDI (Cupra/FR/Topsport)</b> 4WD		99-05	Special-Active STR.T Sport	☉ 8745-1030 ☉ 8750-1063 ☞ 8710-1385Sport	☉ 8245-1032 ☉ 8050-1086 80-2806Sport				
		STR.T Kit Sport Kit				1120-4382 1140-4382	25	25	1,2,13 1,2,13,17	
	<b>Leon (1M) Cupra R</b>	02-05		Sport	☞ 8710-1385Sport	80-2761Sport				
	<b>Leon (1P)</b> Front: for original struts 50 mm only	09.05-12.12		Special-Active STR.T Sport	☉ 8745-1006 ☉ 8750-1006 ☞ 8710-1432Sport	☉ 8045-1084 ☉ 8050-1006 80-2859Sport				
	Front: for original struts 55 mm only		STR.T Kit Sport Kit			1120-1762 1140-1762	40	40	1,2,13 1,2,13,17	
			Special-Active STR.T Sport	☉ 8745-1006 ☉ 8750-1005 ☞ 8710-1431Sport	☉ 8045-1084 ☉ 8050-1006 80-2859Sport					
			STR.T Kit Sport Kit Coil-over Kit			1120-1761 1140-1761 1150-5080-1	40 40 60	40 40 50	1,2,13 1,2,13,17 9,17,21,23 NO T V	
	<b>Leon (1P) FR &amp; Cupra, excl. Cupra R</b>	06-12.12	Special-Active STR.T Sport	☉ 8745-1225 ☉ 8750-1005 ☞ 8710-1431Sport	☉ 8045-1226 ☉ 8050-1006 80-2859Sport					
			STR.T Kit Sport Kit Coil-over Kit			1120-1761 1140-1761 1150-5080-1	40 40 40	40 40 35	1,2,13 1,2,13,17 9,17,21,23 NO T V	
	<b>Leon (5F), excl. DDC, Cupra 2.0TSI 206kW</b> Front: for original struts 50 mm only Rear: only for cars with torsion-beam rear suspension	01.13-18	Special-Active STR.T Sport	☉ 8745-1324 ☉ 8750-1115 ☞ ☉ 8741-1571Sport	☉ 8245-1326 ☉ 8250-1044 ☉ 8240-1296Sport					
	Front axle load up to 930 kg		STR.T Kit Sport Kit			1120-8435 1140-8435	35	35	1,2,13 1,2,13,17	
	Front axle load as from 931 kg, up to 1010 kg		STR.T Kit Sport Kit			1120-8433 1140-8433	35	35	1,2,13 1,2,13,17	
	Front axle load as from 1011 kg		STR.T Kit Sport Kit			1120-8434 1140-8434	35	35	1,2,13 1,2, 13, 17	
	Front: for original struts 50 mm only Rear: only for cars with multi-link suspension		Special-Active STR.T Sport	☉ 8745-1324 ☉ 8750-1115 ☞ ☉ 8741-1571Sport	☉ 8245-1327 ☉ 8250-1050 ☉ 8240-1297Sport					
	Front axle load up to 930 kg		STR.T Kit Sport Kit			1120-8436 1140-8436	35	35	1,2,13 1,2,13,17	
	Front axle load as from 931 kg, up to 1010 kg		STR.T Kit Sport Kit			1120-8431 1140-8431	35	35	1,2,13 1,2,13,17	
	Front axle load as from 1011 kg		STR.T Kit Sport Kit			1120-8432 1140-8432	35	35	1,2,13 1,2,13,17	

MAKE		Year	product range				Lowering up to ..mm		Notes
Model							Front	Rear	
<b>SEAT - CONTINUED</b>									
Front: for original struts 55 mm only Rear: only for cars with torsion-beam rear suspension			Special-Active	Ⓒ 8745-1325		Ⓒ 8245-1326			
			STR.T	Ⓒ 8750-1123		Ⓒ 8250-1044			
			Sport	ⓂⓈ Ⓒ 8741-1572Sport		Ⓒ 8240-1296Sport			
Front axle load up to 930 kg			STR.T Kit				1120-8435-1	35	35
			Sport Kit				1140-8435-1	35	35
Front axle load as from 931 kg, up to 1010 kg			STR.T Kit				1120-8433-1	35	35
			Sport Kit				1140-8433-1	35	35
Front axle load as from 1011 kg			STR.T Kit				1120-8434-1	35	35
			Sport Kit				1140-8434-1	35	35
Front: for original struts 55 mm only Rear: only for cars with multi-link suspension.			Special-Active	Ⓒ 8745-1325		Ⓒ 8245-1327			
			STR.T Kit	Ⓒ 8750-1123		Ⓒ 8250-1050			
			Sport	ⓂⓈ Ⓒ 8741-1572Sport		Ⓒ 8240-1297Sport			
Front axle load up to 930 kg			STR.T Kit				1120-8436-1	35	35
			Sport Kit				1140-8436-1	35	35
Front axle load as from 931 kg, up to 1010 kg			STR.T Kit				1120-8431-1	35	35
			Sport Kit				1140-8431-1	35	35
Front axle load as from 1011 kg			STR.T Kit				1120-8432-1	35	35
			Sport Kit				1140-8432-1	35	35
<b>Leon ST (5F), excl. DDC, 4x4, Cupra 2.0TSI 206kW</b> Front: for original struts 50 mm only Rear: only for cars with torsion-beam rear suspension		01.13-18	Special-Active	Ⓒ 8745-1324		Ⓒ 8245-1326			
			STR.T	Ⓒ 8750-1115		Ⓒ 8250-1044			
			Sport	ⓂⓈ Ⓒ 8741-1571Sport		Ⓒ 8240-1296Sport			
Front axle load up to 930 kg			STR.T Kit				1120-8435	35	35
			Sport Kit				1140-8435	35	35
Front axle load as from 931 kg, up to 1010 kg			STR.T Kit				1120-8433	35	35
			Sport Kit				1140-8433	35	35
Front axle load as from 1011 kg			STR.T Kit				1120-8434	35	35
			Sport Kit				1140-8434	35	35
Front: for original struts 50 mm only Rear: only for cars with multi-link suspension			Special-Active	Ⓒ 8745-1324		Ⓒ 8245-1327			
			STR.T	Ⓒ 8750-1115		Ⓒ 8250-1050			
			Sport	ⓂⓈ Ⓒ 8741-1571Sport		Ⓒ 8240-1297Sport			
Front axle load up to 930 kg			STR.T Kit				1120-8436	35	35
			Sport Kit				1140-8436	35	35
Front axle load as from 931 kg, up to 1010 kg			STR.T Kit				1120-8431	35	35
			Sport Kit				1140-8431	35	35
Front axle load as from 1011 kg			STR.T Kit				1120-8432	35	35
			Sport Kit				1140-8432	35	35
Front: for original struts 55 mm only Rear: only for cars with torsion-beam rear suspension			Special-Active	Ⓒ 8745-1325		Ⓒ 8245-1326			
			STR.T	Ⓒ 8750-1123		Ⓒ 8250-1044			
			Sport	ⓂⓈ Ⓒ 8741-1572Sport		Ⓒ 8240-1296Sport			
Front axle load up to 930 kg			STR.T Kit				1120-8435-1	35	35
			Sport Kit				1140-8435-1	35	35
Front axle load as from 931 kg, up to 1010 kg			STR.T Kit				1120-8433-1	35	35
			Sport Kit				1140-8433-1	35	35
Front axle load as from 1011 kg			STR.T Kit				1120-8434-1	35	35
			Sport Kit				1140-8434-1	35	35
Front: for original struts 55 mm only Rear: only for cars with multi-link suspension.			Special-Active	Ⓒ 8745-1325		Ⓒ 8245-1327			
			STR.T	Ⓒ 8750-1123		Ⓒ 8250-1050			
			Sport	ⓂⓈ Ⓒ 8741-1572Sport		Ⓒ 8240-1297Sport			
Front axle load up to 930 kg			STR.T Kit				1120-8436-1	35	35
			Sport Kit				1140-8436-1	35	35
Front axle load as from 931 kg, up to 1010 kg			STR.T Kit				1120-8431-1	35	35
			Sport Kit				1140-8431-1	35	35
Front axle load as from 1011 kg			STR.T Kit				1120-8432-1	35	35
			Sport Kit				1140-8432-1	35	35
<b>Leon (5F) SC/ST incl. FR, Cupra 265 / 300 &amp; 4Drive</b> Front axle load up to 1090 kg, rear axle load up to 1000 kg		13-18	Trackday Kit				1250-1001	60	50
<b>Mii</b>									
<b>Mii</b>		12-19	Sport			ⓂⓈ Ⓒ 8041-1418Sport			
<b>Toledo</b>									
<b>Toledo 1 (1L) excl. 2.0-16V</b>		91-98	STR.T	Ⓒ 8750-1008		Ⓒ 8050-1007			
			Sport	ⓂⓈ Ⓒ 8741-1258Sport		M3Ⓢ 80-2542Sport			
<b>Toledo 1 (1L) 2.0-16V</b>		91-98	STR.T	Ⓒ 8750-1008		Ⓒ 8050-1008			
			Sport	ⓂⓈ Ⓒ 8741-1258Sport		M3Ⓢ 80-2587Sport			
<b>Toledo 2 (1M) incl. Cupra, excl. "Cupra "</b>		99-04	Special-Active	Ⓒ 8745-1029		Ⓒ 8045-1083			
			STR.T	Ⓒ 8750-1002		Ⓒ 8050-1001			
			Sport	ⓂⓈ 8710-1337Sport		80-2761Sport			
<b>Toledo 2 (1M)</b> Front axle load up to 910 kg		99-04	STR.T Kit				1120-5261	35	35
			Sport Kit				1140-5261	35	35
Front axle load as from 911 kg			STR.T Kit				1120-5262	35	35
			Sport Kit				1140-5262	35	35
<b>Toledo 3 (5P)</b> Front: for original struts 50 mm only		05.04-09	Special-Active			Ⓒ 8045-1084			
			STR.T	Ⓒ 8750-1006		Ⓒ 8050-1006			
			Sport	ⓂⓈ 8710-1432Sport		80-2859Sport			
Front axle load up to 1020 kg			STR.T Kit				1120-2613	35	35
			Sport Kit				1140-2613	35	35

MAKE		Year	product range				Lowering up to ..mm		Notes
Model							Front	Rear	
<b>SEAT - CONTINUED</b>									
Front axle load as from 1021 kg			STR.T Kit			1120-2614	35	35	1,2,13
			Sport Kit			1140-2614	35	35	1,2,13,17
Front: for original struts 55 mm only			Special-Active	Ⓢ 8745-1038	Ⓢ 8045-1084				
			STR.T	Ⓢ 8750-1005	Ⓢ 8050-1006				
Front axle load up to 1020 kg			Sport	Ⓢ 8710-1431Sport	80-2859Sport				
			STR.T Kit			1120-2611	35	35	1,2,13
Front axle load as from 1021 kg			Sport Kit			1140-2611	35	35	1,2,13,17
			Coil-over Kit			1150-5080-1	60	50	9,17,21,23 NO T V
			STR.T Kit			1120-2612	35	35	1,2,13
			Sport Kit			1140-2612	35	35	1,2,13,17
Toledo 4 (NH)	13-18		Coil-over Kit			1150-5080-1	60	50	9,17,21,23 NO T V
			Special-Active	Ⓢ 8745-1278					
			STR.T	Ⓢ 8750-1114	Ⓢ 8050-1017				
			Sport	Ⓢ 8741-1548Sport	80-2815Sport				
<b>SIMCA</b>									
<b>1000 Rallye II</b>									
Rallye II	72-77	Classic		Ⓢ 80-2021SPF1	Ⓢ 82-1857SPF1				On request only
<b>SKODA</b>									
<b>Citigo</b>									
Citigo	12-19	Sport			Ⓢ 8041-1418Sport				
<b>Fabia</b>									
Fabia (6Y) Sedan, Hatchback, Combi	01.00-07		Special-Active	Ⓢ 8745-1069	Ⓢ 8045-1070				
			STR.T	Ⓢ 8750-1004	Ⓢ 8050-1005				
Front axle load up to 900 kg			Sport	Ⓢ 8710-1404Sport	80-2830Sport				
			STR.T Kit			1120-4091	30	30	1,2,13
Front axle load as from 901 kg			Sport Kit			1140-4091	30	30	1,2,13,17
			STR.T Kit			1120-4092	30	30	1,2,13
Fabia (6Y) RS 1.9TDi KONI Sport (Kit), front: to be adjusted one full turn	03-07		Sport Kit	Ⓢ 8710-1404Sport	80-2830Sport				
			STR.T Kit			1140-4092	30	30	1,2,13,17
Fabia (5J) Hatchback 1.2, 1.4, 1.6, 1.2/1.4/1.9TDi	12.06-14		Special-Active	Ⓢ 8745-1069	Ⓢ 8045-1070				
			STR.T	Ⓢ 8750-1004	Ⓢ 8050-1005				
Front axle load up to 900 kg			Sport	Ⓢ 8710-1404Sport	80-2830Sport				
			STR.T Kit			1120-0731	40	40	1,2,13
Front axle load as from 901 kg			Sport Kit			1140-0731	40	40	1,2,13,17
			STR.T Kit			1120-0732	40	40	1,2,13
			Sport Kit			1140-0732	40	40	1,2,13,17
Fabia (5J) Hatchback RS 1.4 TSi	10-14		Sport	Ⓢ 8710-1404Sport	80-2830Sport				
			Sport Kit			1140-0735	40	40	1,2,13,17
Fabia (5J) Combi 1.2, 1.4, 1.6, 1.2/1.4/1.9TDi	10.07-14		Special-Active	Ⓢ 8745-1069	Ⓢ 8045-1070				
			STR.T	Ⓢ 8750-1004	Ⓢ 8050-1005				
Front axle load up to 900 kg			Sport	Ⓢ 8710-1404Sport	80-2830Sport				
			STR.T Kit			1120-0733	40	40	1,2,13
Front axle load as from 901 kg			Sport Kit			1140-0733	40	40	1,2,13,17
			STR.T Kit			1120-0734	40	40	1,2,13
			Sport Kit			1140-0734	40	40	1,2,13,17
Fabia (5J) Combi RS 1.4 TSi KONI Sport (Kit), front: to be adjusted one full turn	10-14		Sport	Ⓢ 8710-1404Sport	80-2830Sport				
			Sport Kit			1140-0736	30-35	30-35	1,2,13,17
Fabia (NJ) Hatchback/Combi excl. DCC (Dynamic Chassis Control)	15-19		Special-Active	Ⓢ 8745-1278	Ⓢ 8045-1070				
			STR.T	Ⓢ 8750-1114	Ⓢ 8050-1005				Front: I.D.
			Sport	Ⓢ 8741-1548Sport	80-2830Sport				
<b>Karoq</b>									
Karoq 1.0TSi, 1.5 TSi, 1.6TDi, 2.0TDi excl. DCC (Dynamic Chassis Control)	07.17-	Special-Active		I.D.	I.D.				
<b>Kodiahq</b>									
Kodiahq 1.4TSi, 2.0TSi, 2.0TDi incl. 4x4 excl Scout excl. DCC (Dynamic Chassis Control)	10.16-	Special-Active	Ⓢ 8745-1388		Ⓢ 8245-1387				
		Sport	Ⓢ 8741-1572Sport		Ⓢ 8240-1311Sport				
<b>Octavia</b>									
Octavia 1 Sedan	01.97-05.04		Special	▲ 87-2571	▲ 80-2761				
			Special-Active	Ⓢ 8745-1029	Ⓢ 8045-1083				
Front axle load up to 910 kg			STR.T	Ⓢ 8750-1002	Ⓢ 8050-1001				
			Sport	Ⓢ 8710-1337Sport	80-2761Sport				
Front axle load as from 911 kg			STR.T Kit			1120-7671	35	35	1,2,13,15
			Sport Kit			1140-7671	35	35	1,2,13,15,17
with .D. suspension			STR.T Kit			1120-7672	35	35	1,2,13,15
			Sport Kit			1140-7672	35	35	1,2,13,15,17
Octavia 1 Combi	06.98-05.04		Special-Active	Ⓢ 8745-1030	Ⓢ 8045-1083				
			STR.T	Ⓢ 8750-1063	Ⓢ 8050-1001				
Front axle load up to 910 kg			Sport	Ⓢ 8710-1385Sport	80-2761Sport				
			Special	▲ 87-2571					
			Special-Active	Ⓢ 8745-1029	Ⓢ 8045-1083				
			STR.T	Ⓢ 8750-1002	Ⓢ 8050-1017				
			Sport	Ⓢ 8710-1337Sport	80-2815Sport				
			STR.T Kit			1120-7673	35	35	1,2,13,15
			Sport Kit			1140-7673	35	35	1,2,13,15,17

MAKE		product range			Lowering up to ..mm		Notes	
Model	Year				Front	Rear		
<b>SKODA - CONTINUED</b>								
Front axle load as from 911 kg		STR.T Kit			1120-7674	35	35	1,2,13,15
		Sport Kit			1140-7674	35	35	1,2,13,15,17
with .D. suspension		Special-Active	Ⓒ 8745-1030	Ⓒ 8045-1083				
		STR.T	Ⓒ 8750-1063	Ⓒ 8050-1017				
		Sport	Ⓜ 8710-1385Sport	80-2815Sport				
<b>Octavia 1 4WD 1.8T, 2.0, 1.9TDi, Sedan &amp; Combi</b>	99-04	Special-Active	Ⓒ 8745-1030					
		STR.T	Ⓒ 8750-1063					
		Sport	Ⓜ 8710-1385Sport					
<b>Octavia 1 RS Sedan</b>	00-04	Special-Active	Ⓒ 8745-1030	Ⓒ 8045-1083				
		STR.T	Ⓒ 8750-1063	Ⓒ 8050-1001				
		Sport	Ⓜ 8710-1385Sport	80-2761Sport				
		STR.T Kit			1120-1241	20	20	1,2,13
		Sport Kit			1140-1241	20	20	1,2,13,17
<b>Octavia 1 RS Combi</b>	00-04	STR.T	Ⓒ 8750-1063	Ⓒ 8050-1017				
		Sport	Ⓜ 8710-1385Sport	80-2815Sport				
		STR.T Kit			1120-1242	20	20	1,2,13
		Sport Kit			1140-1242	20	20	1,2,13,17
<b>Octavia 2 Sedan, excl. RS, HD susp.</b> Front: for original struts 50 mm only	05-12	Special-Active		Ⓒ 8045-1084				
		STR.T	Ⓒ 8750-1006	Ⓒ 8050-1006				
		Sport	Ⓜ 8710-1432Sport	80-2859Sport				
Front axle load up to 1020 kg		STR.T Kit			1120-2613	35	35	1,2,13
		Sport Kit			1140-2613	35	35	1,2,13,17
Front axle load as from 1021 kg		STR.T Kit			1120-2614	35	35	1,2,13
		Sport Kit			1140-2614	35	35	1,2,13,17
Front: for original struts 55 mm only		Special-Active	Ⓒ 8745-1006	Ⓒ 8045-1084				
		STR.T	Ⓒ 8750-1005	Ⓒ 8050-1006				
		Sport	Ⓜ 8710-1431Sport	80-2859Sport				
Front axle load up to 1020 kg		STR.T Kit			1120-2611	35	35	1,2,13
		Sport Kit			1140-2611	35	35	1,2,13,17
Front axle load as from 1021 kg		STR.T Kit			1120-2612	35	35	1,2,13
		Sport Kit			1140-2612	35	35	1,2,13,17
<b>Octavia 2 Combi, excl. RS, HD susp., 4x4</b> Front: for original struts 50 mm only	05-12	Special-Active		ⓃⒸ 8045-1084				
		STR.T	Ⓒ 8750-1006	ⓃⒸ 8050-1006				
		Sport	Ⓜ 8710-1432Sport	Ⓝ 80-2859Sport				
Front axle load up to 1020 kg		STR.T Kit			1120-2613	35	35	1,2,13
		Sport Kit			1140-2613	35	35	1,2,13,17
Front axle load as from 1021 kg		STR.T Kit			1120-2614	35	35	1,2,13
		Sport Kit			1140-2614	35	35	1,2,13,17
Front: for original struts 55 mm only		Special-Active	Ⓒ 8745-1038	ⓃⒸ 8045-1084				
		STR.T	Ⓒ 8750-1005	ⓃⒸ 8050-1006				
		Sport	Ⓜ 8710-1431Sport	Ⓝ 80-2859Sport				
Front axle load up to 1020 kg		STR.T Kit			1120-2611	35	35	1,2,13
		Sport Kit			1140-2611	35	35	1,2,13,17
Front axle load as from 1021 kg		STR.T Kit			1120-2612	35	35	1,2,13
		Sport Kit			1140-2612	35	35	1,2,13,17
<b>Octavia 2 RS, Sedan &amp; Combi</b>	06-12	Special-Active	Ⓒ 8745-1225	ⓃⒸ 8045-1226				
		STR.T	Ⓒ 8750-1005	ⓃⒸ 8050-1006				
		Sport	Ⓜ 8710-1431Sport	Ⓝ 80-2859Sport				
		STR.T Kit			1120-2612	35	35	1,2,13,15
		Sport Kit			1140-2612	35	35	1,2,13,15,17
<b>Octavia 2, HD susp. &amp; 4x4, Sedan &amp; Combi</b> Front: for original struts 50 mm only	05-12	Sport	Ⓜ 8710-1432Sport					
Front: for original struts 55 mm only		Special-Active	Ⓒ 8745-1038					
		Sport	Ⓜ 8710-1431Sport					
<b>Octavia 3 Sedan, excl. RS230, HD susp.</b> Front: for original struts 50 mm only Rear: only for cars with torsion-beam rear suspension	01.13-19	Special-Active	Ⓒ 8745-1324	Ⓒ 8245-1326				
		STR.T	Ⓒ 8750-1115	Ⓒ 8250-1044				
		Sport	ⓂⒸ 8741-1571Sport	Ⓒ 8240-1296Sport				
Front axle load up to 1010 kg		Sport Kit			I.D.			
Front axle load as from 1011 kg		Sport Kit			I.D.			
Front: for original struts 50 mm only Rear: only for cars with multi-link suspension		Special-Active	Ⓒ 8745-1324	Ⓒ 8245-1327				
		STR.T	Ⓒ 8750-1115	Ⓒ 8250-1050				
		Sport	ⓂⒸ 8741-1571Sport	Ⓒ 8240-1297Sport				
Front axle load up to 1010 kg		Sport Kit			I.D.			
Front axle load as from 1011 kg		Sport Kit			I.D.			
Front: for original struts 55 mm only Rear: only for cars with torsion-beam rear suspension		Special-Active	Ⓒ 8745-1325	Ⓒ 8245-1326				
		STR.T	Ⓒ 8750-1123	Ⓒ 8250-1044				
		Sport	ⓂⒸ 8741-1572Sport	Ⓒ 8240-1296Sport				
Front axle load up to 1010 kg		Sport Kit			I.D.			
Front axle load as from 1011 kg		Sport Kit			I.D.			
Front: for original struts 55 mm only Rear: only for cars with multi-link suspension.		Special-Active	Ⓒ 8745-1325	Ⓒ 8245-1327				
		STR.T	Ⓒ 8750-1123	Ⓒ 8250-1050				
		Sport	ⓂⒸ 8741-1572Sport	Ⓒ 8240-1297Sport				
Front axle load up to 1010 kg		Sport Kit			I.D.			
Front axle load as from 1011 kg		Sport Kit			I.D.			



MAKE	Model	Year	product range				Lowering up to ..mm		Notes
							Front	Rear	
<b>SKODA - CONTINUED</b>									
	<b>Octavia 3 Combi, excl. RS230, HD susp., Scout 4x4</b> Front: for original struts 50 mm only Rear: only for cars with torsion-beam rear suspension	01.13-19	Special-Active	© 8745-1324		© 8245-1326			
	Front axle load up to 1010 kg		STR.T	© 8750-1115		© 8250-1044			
	Front axle load as from 1011 kg		Sport	☞ © 8741-1571Sport		© 8240-1296Sport			
	Front: for original struts 50 mm only Rear: only for cars with multi-link suspension		Sport Kit				I.D.		
	Front axle load up to 1010 kg		Sport Kit				I.D.		
	Front axle load as from 1011 kg		Special-Active	© 8745-1324		© 8245-1327			
	Front: for original struts 55 mm only Rear: only for cars with torsion-beam rear suspension		STR.T	© 8750-1115		© 8250-1050			
	Front axle load up to 1010 kg		Sport	☞ © 8741-1571Sport		© 8240-1297Sport			
	Front axle load as from 1011 kg		Sport Kit				I.D.		
	Front: for original struts 55 mm only Rear: only for cars with multi-link suspension.		Sport Kit				I.D.		
	Front axle load up to 1010 kg		Special-Active	© 8745-1325		© 8245-1327			
	Front axle load as from 1011 kg		STR.T	© 8750-1123		© 8250-1050			
	Front: for original struts 55 mm only Rear: only for cars with multi-link suspension.		Sport	☞ © 8741-1572Sport		© 8240-1297Sport			
	Front axle load up to 1010 kg		Sport Kit				I.D.		
	Front axle load as from 1011 kg		Sport Kit				I.D.		
<b>Rapid</b>									
	<b>Rapid</b>	12-18	Special-Active	© 8745-1278					
			STR.T	© 8750-1114		© 8050-1017			Front: I.D.
			Sport	☞ © 8741-1548Sport		80-2815Sport			
			Sport Kit				I.D.		
<b>Roomster</b>									
	<b>Roomster 1.2, 1.4, 1.6, 1.4TDi, 1.9TDi excl. Scout</b>	06-14	STR.T	© 8750-1004		© 8050-1017			
			Sport	☞ 8710-1404Sport		80-2815Sport			
			STR.T Kit				1120-0821	40	40
			Sport Kit				1140-0821	40	40
<b>Superb</b>									
	<b>Superb 1</b>	02-08	STR.T	© 8250-1001		© 8050-1009			
	Front axle load up to 1115 kg		Sport	82-2488Sport		© 8040-1227Sport			
	Front axle load as from 1116 kg		Sport Kit				1140-7932	40	40
			Sport Kit				1140-7931	40	40
	<b>Superb 2 Sedan 1.4, 1.8, 3.6, 1.6/1.9/2.0TDi 2WD</b>	08-05-15	Special-Active	© 8745-1038		☺ © 8045-1085			
	Front axle load up to 1069 kg		Sport	☞ © 8741-1488Sport		☺ © 8040-1352Sport			
	Front axle load as from 1070 kg		Sport Kit				1140-1621	40	40
	4WD		Sport Kit				1140-1622	40	40
	Front axle load up to 1069 kg		Special-Active	© 8745-1038		© 8045-1085			
	Front axle load as from 1070 kg		Sport	☞ © 8741-1488Sport		© 8040-1352Sport			
			Sport Kit				1140-1623	40	40
			Sport Kit				1140-1624	40	40
	<b>Superb 2 Combi 1.4, 1.8, 3.6, 1.6/1.9/2.0TDi 2WD</b>	09-05-15	Special-Active	© 8745-1038		☺ © 8045-1085			
	Front axle load up to 1069 kg		Sport	☞ © 8741-1488Sport		☺ © 8040-1352Sport			
	Front axle load as from 1070 kg		Sport Kit				1140-1623	40	40
	4WD		Sport Kit				1140-1624	40	40
	Front axle load up to 1069 kg		Special-Active	© 8745-1038		© 8045-1085			
	Front axle load as from 1070 kg		Sport	☞ © 8741-1488Sport		© 8040-1352Sport			
			Sport Kit				1140-1625	40	40
			Sport Kit				1140-1626	40	40
	<b>Superb Sedan 3</b> Incl. Sport suspension, 4Motion excl. DCC (Dynamic Chassis Control), D suspension	03.15-	Special-Active	© 8745-1388		☺ © 8245-1387			
			Sport	☞ © 8741-1572Sport		☺ © 8240-1311Sport			
	<b>Superb Combi 3</b> Incl. Sport suspension, 4Motion excl. DCC (Dynamic Chassis Control), D suspension, self-leveling system	03.15-	Special-Active	© 8745-1388		☺ © 8245-1387			15
			Sport	☞ © 8741-1572Sport		☺ © 8240-1311Sport			
<b>Yeti</b>									
	<b>Yeti 2WD</b> Front: for original struts 50 mm only	05.09-17	Sport	☞ 8710-1432Sport					
	Front: for original struts 55 mm only		Special-Active	© 8745-1038					
			Sport	☞ 8710-1431Sport					
	<b>Yeti 4WD</b> Front: for original struts 50 mm only	05.09-17	Sport	☞ 8710-1432Sport					
	Front: for original struts 55 mm only		Special-Active	© 8745-1038					
			Sport	☞ 8710-1431Sport					
<b>SSANG YONG</b>									
<b>Actyon</b>									
	<b>Actyon 2.3, 2.0 D</b>	09.07-12	eavy Track	© 8240-1281					
<b>Korando</b>									
	<b>Korando (KJ) 2-door</b>	96-05	eavy Track	© ▲ 26-1621		© ▲ 26-1622			
<b>Kyron</b>									
	<b>Kyron 3.2, 2.0D, 2.7D</b> (Car will be lowered by approx. 10 mm)	05-09.07	Sport	© 8240-1204Sport					
<b>Musso</b>									
	<b>Musso (602) AWD</b>	94-05	eavy Track	© ▲ 26-1621		© ▲ 26-1622			

MAKE	Model	Year	product range				Lowering up to ..mm		Notes
							Front	Rear	
<b>SSANG YONG - CONTINUED</b>									
<b>Rexton</b>									
	Rexton (Y200) 2.3 16V, 3.2 24V, 2.9TD AWD	02-05	Sport	Ⓒ 8240-1204Sport	Ⓒ 8040-1298Sport				
	Rexton (Y250/Y300) 320, 270 XDi, excl. IRS AWD	06-17	eavy Track	Ⓒ 8240-1281	Ⓒ 8040-1404				
	Rexton (Y250/Y300) 320, 270 XDi, with IRS AWD	06-17	eavy Track	Ⓒ 8240-1281	80-2902				
<b>SUBARU</b>									
<b>BRZ</b>									
	BRZ	12-19	Sport	ⒸⒹ 8741-1560LSport ⒸⒹ 8741-1560RSport	ⒸⒹ 8041-1416Sport				
			Sport Kit			1140-8561	25	25	1,2,13,16
<b>Impreza</b>									
	Impreza 2.0GT Turbo Sedan / Wagon (Plus) 4WD Front + Rear: for original struts only	94-00	Sport	ⒸⒹⒺ 8610-1351Sport	ⒸⒹⒺ 8610-1352Sport				
	Impreza GD/GG A 'Bug Eye' 1.6, 2.0 Front + Rear: for original struts only	00-02	Sport Sport Kit	ⒸⒹⒺ 8610-1351Sport	ⒸⒹⒺ 8610-1408Sport	1140-3561	35	35	1,2,13,16
	Impreza GD/GG A 'Bug Eye' 2.0 WRX, excl. STI Front + Rear: for original struts only, excluding mono-tube inverted strut design	00-02	Sport Sport Kit	ⒸⒹⒺ 8610-1351Sport	ⒸⒹⒺ 8610-1408Sport	1140-3561	35	35	1,2,13,16
	Impreza GD/GG B-E 'Blob Eye' 1.6, 2.0 Front + Rear: for original struts only	02-05	Sport Sport Kit	ⒸⒹⒺ 8610-1351Sport	ⒸⒹⒺ 8610-1408Sport	1140-3562	35	35	1,2,13,16
	Impreza GD/GG B-E 'Blob Eye' 2.0 WRX, excl. STI Front + Rear: for original struts only, excluding mono-tube inverted strut design	02-05	Sport Sport Kit	ⒸⒹⒺ 8610-1351Sport	ⒸⒹⒺ 8610-1408Sport	1140-3562	35	35	1,2,13,16
	Impreza GD/GG F-G 'Hawk Eye' 1.5, 2.0 Front + Rear: for original struts only	05-07	Sport Sport Kit	ⒸⒹⒺ 8610-1351Sport	ⒸⒹⒺ 8610-1440Sport	1140-3563	35	35	1,2,13,16
	Impreza GD/GG F-G 'Hawk Eye' 2.5 WRX, excl. STI Front + Rear: for original struts only, excluding mono-tube inverted strut design	05-07	Sport Sport Kit	ⒸⒹⒺ 8610-1351Sport	ⒸⒹⒺ 8610-1440Sport	1140-3563	35	35	1,2,13,16
	Impreza GE/GH/GR/GV 1.5, 2.0(D), 2.5WRX excl. STI Excluding mono-tube inverted strut design	10.07-11	Sport Sport Kit	ⒸⒹ 8710-1454LSport ⒸⒹ 8710-1454RSport	ⒸⒹ 8010-1055Sport				
	WRX 4x4, excl STi versions	15-	Sport	I.D.	I.D.	1140-0461S	35	35	1,2,13,15,16
<b>Legacy</b>									
	Legacy (Liberty) 2.0, 3.0, 3.0R incl. GT Wagon Front: for K B struts only	05-09	Sport Sport Kit	ⒸⒹⒺ 8610-1447Sport	ⒸⒹⒺ 8010-1053Sport	1140-1671	35	35	1,2,13,15,16
<b>Traviq</b>									
	Traviq M220, M182	01-05	Sport	ⒸⒹⒺ 8710-1369LSport ⒸⒹⒺ 8710-1369RSport					
<b>WRX</b>									
	WRX 4x4, excl STi versions	15-	Sport	I.D.	I.D.				
<b>SUZUKI</b>									
<b>Jimny</b>									
	Jimny 2WD 4WD	10.98-18	eavy Track	Ⓒ 8040-1300	Ⓒ 8040-1301				
<b>SJ</b>									
	SJ 410 / SJ 413 Jimny / Samurai (4WD)	88-95	eavy Track		Ⓒ▲ 26-1369				
<b>Swift</b>									
	Swift / Cultus GTi 1.3-16V (EAA33 / EAA34 / EAF35) Front: for K B and Showa only	89-96	Sport	◆ 86-2588Sport	□ 87-2429Sport				
	Swift / Cultus Sedan 1.6-16V / Hatchback 1.0, 1.3 types EAA35, EAB35, EA 35, EAA44, EAB44, A 14, AJ14	89-96	Sport	◆ 86-2588Sport	□ 87-2429Sport				
	Swift / Cultus 1.0, 1.3 series M Front: for K B and Showa only	97-02	Sport	◆ 86-2588Sport	□ 87-2429Sport				
	Swift MZ/EZ 1.3, 1.5	02.05-06.10	STR.T	Ⓒ 8750-1092L Ⓒ 8750-1092R	Ⓒ 8050-1125				
	1.6 Sport, 1.3 D		STR.T Kit			1120-1601	30	30	1,2,13
			STR.T Kit			1120-1602	30-35	30-35	1,2,13
	Swift FZ/NZ	07.10-17	Sport	ⒸⒹ 8741-1581LSport ⒸⒹ 8741-1581RSport	ⒸⒹ 8041-1426Sport				
			Sport Kit			1140-8931-1	20	35	1, 2, 13, 16
	Swift Swift FZ/NZ Sport	12-17	Sport	ⒸⒹ 8741-1581LSport ⒸⒹ 8741-1581RSport	ⒸⒹ 8041-1426Sport				
			Sport Kit			1140-8931-2	30	30	1, 2, 13, 16
<b>Splash</b>									
	Splash	09.07-15	STR.T	Ⓒ 8750-1092L Ⓒ 8750-1092R	Ⓒ 8050-1125				
	1.0, 1.2		STR.T Kit			1120-1601	30	30	1,2,13
	1.3 D		STR.T Kit			1120-1602	30-35	30-35	1,2,13
<b>Vitara</b>									
	Vitara/Grand Vitara/Escudo/Sidekick, excl. XL-7	88-05	eavy Track	ⒸⒹ 8741-1394Sport	Ⓒ 8040-1106Sport				
	Grand Vitara (7T,TE,TD) 2.0, 2.4, 2.7, 3.2, 1.9D Front: for original struts only	05-16	Special-Active eavy Track	Ⓒ 8645-1174 ⒸⒹⒺ▲ 8641-1510	Ⓒ 8245-1175				
	X-90	96-98	eavy Track	ⒸⒹ 8741-1394Sport	Ⓒ 8040-1106Sport				
<b>TOYOTA</b>									
<b>Avensis</b>									
	Avensis (T25) Sedan, Hatchback Front: for original struts only	03-07	Sport		▲ 80-2865Sport				
	Avensis (T25) Wagon Front: for original struts only	03-07	Sport		Ⓒ▲ 80-2865Sport				

MAKE	Model	Year	product range				Lowering up to ..mm		Notes	
							Front	Rear		
<b>TOYOTA - CONTINUED</b>										
<b>Aygo</b>										
	Aygo (AB10) 1.0i, 1.4 D4D	05-04-14	STR.T	Ⓒ 8750-1090L Ⓒ 8750-1090R		Ⓒ 8050-1110				
			STR.T Kit				1120-1541	35	35	1,2,13
	Aygo (AB40)	05-14-19	STR.T	Ⓒ 8750-1090L Ⓒ 8750-1090R		Ⓒ 8050-1110				
			STR.T Kit				1120-1541	35	35	1, 2, 13
<b>Camry</b>										
	Camry 2.4, 3.0-V6 Front + Rear: for original struts only	02-06	Sport	Ⓒ 8610-1421Sport						
<b>Carina / Corona</b>										
	Carina Sedan / Wagon (TA40A / TA40LG / TA47)	78-81	Sport			86-1991Sport				
	Carina Sedan/Coupé/Station Wagon (TA60/TA62/CA60)	82-83	Sport			86-1991Sport				
<b>Celica</b>										
	Celica Liftback 2000 (RA40B/L, RA42, RA45)	78-81	Sport			86-1991Sport				
	Celica Coupé 1600 (TA40B/L, TA45)	78-81	Sport			86-1991Sport				
	Celica Liftback GTS (AA63)	84-85	Sport			86-1991Sport				
	Celica Coupé 1.8-16V VVTi incl -Sport (ZZT230/231) Front: for original struts only, excl. K B 48520-2B290 - Rear: excl. OE no. 47530-2B760 ( SA models)	99-06	Sport Sport Kit	Ⓒ 8641-1409Sport		Ⓒ 8041-1276Sport	1140-4141	30	30	1,2,13,16
<b>Corolla</b>										
	Corolla Sedan / Coupé / Station Wagon	75-79	Sport			86-1991Sport				
	Corolla GT Coupé DOHC, Liftback DX, SE 1.6 types TE70, TE71, TE72, CE70L Diesel Sedan	80-83	Sport			86-1991Sport	80-2437Sport			
	Corolla GT-TC 16 Coupé (AE86) rear wheel drive	83-87	Sport			86-1991Sport	80-2437Sport			
<b>Dyna</b>										
	Dyna 300 (BU75 / BU85 / BU88)	87-00	heavy Track				80-2458			
<b>FJ Cruiser</b>										
	FJ Cruiser 4.0-V6 (4WD) RAID dampers: fit vehicles with standard or raised suspension, Front Rear: 0 - 30 mm	06-16	T RAID		88-1712SP2		90-5404LSP1 90-5404RSP1			
	fit vehicles with raised suspension Rear: 30 - 50 mm		T RAID				90-5404LSP2 90-5404RSP2			
<b>Fortuner</b>										
	Fortuner	05-15	heavy Track		82-2560SP1		82-2606			
	Fortuner	07.15-19	heavy Track		82-2632		I.D.			
			T RAID		88-1830		I.D.			
<b>GT86</b>										
	GT86	12-19	Sport	Ⓒ 8741-1560LSport Ⓒ 8741-1560RSport		Ⓒ 8041-1416Sport				
			Sport Kit				1140-8561	25	25	1,2,13,16
<b>Hi-Ace</b>										
	Hi-Ace 1600 (RH11 / RH20 / RH30)	74-82	Classic				80-1904			
	Hi-Ace Diesel (LH11 / LH30)	79-82	Classic				80-1904			
	Hi-Ace 1800 (YH50 / YH60)	83-84	Classic				80-1904			
	Hi-Ace Diesel (LH50 / LH60)	83-84	Classic				80-1904			
	Hi-Ace 2.4 Diesel (LH56 / LH66 / LH108 / LH118) AWD	87-95	Special	Ⓒ 30-1417			Ⓒ 30-1418			
	Hi-Ace 2.0, 2.4 (RZH102 / 103 / 112 / 113 / 115)	90-95	Special	Ⓒ 30-1417			Ⓒ 30-1418			
	Hi-Ace 2.4 Diesel (LH102 / LH112)	90-95	Special	Ⓒ 30-1417			Ⓒ 30-1418			
	Hi-Ace (LXH12 / -22, RCH12 / -13 / -22 / -23) 2WD Rear: for Asia only	96-08.04	Special	Ⓒ 30-1417			Ⓒ 30-1418			
	Hi-Ace (H200) for Asia only 2WD	05-16	Special	Ⓒ 30-1417			Ⓒ 30-1418			
<b>Hi-Lux</b>										
	Hi-Lux Pickup (RN36 / -37, LN36 / -46) AWD	79-83	heavy Track				82-2138			
	Hi-Lux Pickup (YN105 / -106, LN105 / -106) AWD	89-03	heavy Track			Ⓒ 30-1407				
	Hi-Lux Pickup (YN110, LN108 / -110, RN106 / -110) AWD	89-97	heavy Track			Ⓒ 30-1407				
	Hi-Lux Pickup (LN165L / -170L, RZN168 / -173) AWD	08.97-04	heavy Track			▲ 82-2511L ▲ 82-2511R				
	Hi-Lux Pickup AWD Fit vehicles with standard or raised suspension, Front Rear: 0 - 30 mm	05-14	heavy Track T RAID	82-2560SP1 88-1713			82-2561SP1 90-5410SP1			
	Hi-Lux Pickup AWD Fit vehicles with standard or raised suspension, Front Rear: 0 - 30 mm	15-19	heavy Track	82-2632			82-2633			
	Fit vehicles with standard or raised suspension, Front Rear: 0 - 40 mm		T RAID	88-1830			90-5479			
<b>Landcruiser</b>										
	Landcruiser (FJ40 / -42 / -43 / -45, HJ45)	60-79	heavy Track		80-1904		80-1905			
	NOTE: these dampers are only for vehicles raised 50mm - additional parts are needed		heavy Track		82-5020		82-2138			
	Landcruiser (BJ40 / -42 / -43 / -45 / -46)	74-84	heavy Track		80-1904		82-2138			
	NOTE: these dampers are only for vehicles raised 50mm - additional parts are needed		heavy Track		82-5020		82-2297			
	Landcruiser (FJ40 / -43 / -45)	80-86	heavy Track		80-1904		82-2138			
	NOTE: these dampers are only for vehicles raised 50mm - additional parts are needed		heavy Track		82-5020		82-2297			heavy Duty

MAKE	Model	Year	product range				Lowering up to ..mm		Notes
							Front	Rear	
<b>TOYOTA - CONTINUED</b>									
	<b>Landcruiser (HJ41 / -45 / -47)</b>	80-84	easy Track	80-1904		82-2138			
	NOTE: these dampers are only for vehicles raised 50mm - additional parts are needed		easy Track	82-5020		82-2297			
	<b>Landcruiser Station Wagon (BJ55 / FJ55)</b>	72-80	easy Track			82-2138			
	<b>Landcruiser (BJ60 / FJ60 / HJ60 / HJ61)</b> Station Wagon, Custom G. up to chassiso. 33417	81-10.85	easy Track	82-2205		82-2138			
	NOTE: these dampers are only for vehicles raised 50mm - additional parts are needed		easy Track	82-2296		82-2297			
	<b>Landcruiser (BJ60 / FJ60 / HJ60 / HJ61)</b> Station Wagon, Custom G. as from chassiso. 33418	11.85-89	easy Track	82-2205					
	NOTE: these dampers are only for vehicles raised 50mm - additional parts are needed		easy Track	82-2296		82-2294			
	<b>Landcruiser (LJ70 / -73, RJ70 / -73, Bundera)</b> (with coil springs) up to chassiso. 09048994	85-89	easy Track	Ⓢ ▲ 30-1268		Ⓢ ▲ 30-1269L Ⓢ ▲ 30-1270R			
	<b>Landcruiser (LJ70 / -73, RJ70 / -73, Bundera)</b> (with coil springs) as from chassiso. 09048995	90-95	easy Track	82-2374		82-2375			
	<b>Landcruiser (PZJ70 / -73, HZJ70 / -73)</b> with leaf springs	90-07.99	easy Track			Ⓢ 30-1407			
	<b>Landcruiser (FJ75 / HJ75)</b>	84-90	easy Track	82-2205					
	NOTE: these dampers are only for vehicles raised 50mm - additional parts are needed		easy Track	82-2296		82-2312			
	<b>Landcruiser (HZJ75)</b>	90-94	easy Track	82-2205		82-2312			
	NOTE: these dampers are only for vehicles raised 50mm - additional parts are needed		easy Track	82-2296		82-2348SP1			
	<b>Landcruiser (HZJ71 / -74 / -76 / -78 / -79)</b>	99-18	easy Track	82-2347SP1		82-2312			
			T RAID			90-5442			
	fit vehicles with raised suspension, Front 50 mm Rear: 0 - 30 mm		easy Track	82-2347		82-2348SP1			
			T RAID	90-5441		90-5442			
	fit vehicles with raised suspension, Front: 50 mm Rear: 30 - 50 mm		easy Track	82-2347		82-2348			
			T RAID	90-5441					
	<b>Landcruiser (FJ80 / HZJ80 / HDJ80 / HZJ105)</b> with coil springs	90-02	easy Track	Ⓢ 30-1426		Ⓢ 30-1427			
	For vehicles with raised suspension, Front: Rear: 0 - 50 mm		easy Track	82-2385		82-2386			
			easy Track	88-1688		88-1689			on request
			T RAID	90-5389SP2		90-5390SP2			
	<b>Landcruiser 90-Series (Prado / Challenger)</b> Coil spring suspension, J90 (s.w.b.) and J95 (l.w.b.)	96-02	easy Track	82-2446		82-2447			
	RAID Dampers: fit vehicles with standard or raised suspension, Front Rear: 0 - 50 mm		T RAID	88-1711		90-5394			
	<b>Landcruiser 100-Series (HDJ- &amp; UZJ-)</b> excl. active height control	98-07	easy Track	Ⓢ 8240-1183SP		Ⓢ Ⓢ 8240-1184SP			
	RAID Dampers: fit vehicles with standard or raised suspension, Front Rear: 0 - 50 mm		T RAID	90-5397SP1		Ⓢ 90-5398SP1			
	<b>Landcruiser 120/125 (Prado)</b> excl. air suspension	03-09	easy Track	82-2522		82-2523			
	RAID dampers: fit vehicles with standard or raised suspension, Front Rear: 0 - 30 mm		T RAID	88-1712SP2		90-5404LSP1 90-5404RSP1			
	fit vehicles with raised suspension Rear: 30 - 50 mm		T RAID			90-5404LSP2 90-5404RSP2			
	<b>Landcruiser 150 (Prado)</b> excl. air suspension	09-19	easy Track	82-2522		82-2523			
	RAID dampers: fit vehicles with standard or raised suspension, Front Rear: 0 - 30 mm		T RAID	88-1712SP2		90-5404LSP1 90-5404RSP1			
	fit vehicles with raised suspension Rear: 30 - 50 mm		T RAID			90-5404LSP2 90-5404RSP2			
	<b>Landcruiser 200</b> excl. active height control. RAID Dampers: fit vehicles with standard or raised suspension, Front Rear: 0 - 30 mm	08-19	easy Track	88-1747		88-1748			
			T RAID	90-5447SP1		90-5448			
	<b>FJ Cruiser 4.0-V6 (4WD)</b> RAID dampers: fit vehicles with standard or raised suspension, Front Rear: 0 - 30 mm	06-16	T RAID	88-1712SP2		90-5404LSP1 90-5404RSP1			
	fit vehicles with raised suspension Rear: 30 - 50 mm		T RAID			90-5404LSP2 90-5404RSP2			
<b>MR2</b>									
	<b>MR2 / Silver 1.6 TC 16 (AW11)</b> Rear: with locknut M42x1	85-07.86	Sport	Ⓢ Ⓢ 8641-1071Sport		Ⓢ Ⓢ 8641-1072Sport			
	<b>MR2 / Silver 1.6 TC 16 (AW11)</b> Rear: with locknut M48x1,5	08.86-89	Sport	Ⓢ Ⓢ 8641-1071Sport		Ⓢ Ⓢ 8641-1142Sport			
	<b>MR2 / Silver 2.0 TC (SW20)</b>	90-09.96	Sport	Ⓢ Ⓢ 8641-1220Sport		Ⓢ Ⓢ 8641-1221Sport			
			Sport Kit				1140-8841	20	20
	<b>MR2 Spyder 1.8-16V (ZZW30)</b> Front + Rear: for original struts only	00-04	Sport	Ⓢ Ⓢ ◆ 8641-1420Sport		Ⓢ Ⓢ ◆ 8641-1422Sport			
			Sport Kit				1140-3991	30	30
<b>Prius</b>									
	<b>Prius Hybrid, Plug-in Hybrid, excl. Prius Wagon</b>	06.09-15	Special-Active	Ⓢ 8745-1321L Ⓢ 8745-1321R		Ⓢ 8245-1322			
<b>RAV4</b>									
	<b>RAV4 (FunCruiser)</b> Front: for non-sealed struts only	94-12.97	easy Track	Ⓢ Ⓢ 8641-1319Sport		Ⓢ 30-1599Sport			
	<b>RAV4</b> Front: for original struts only	01.98-08.00	easy Track	Ⓢ Ⓢ ◆ 8641-1427Sport		Ⓢ 30-1599Sport			
	<b>RAV4 (ZAC2 / ACA2 / CLA2)</b> Front: for original struts only	09.00-05	easy Track	Ⓢ Ⓢ ◆ 8641-1427Sport		Ⓢ 30-1599Sport			

MAKE	Model	Year	product range				Lowering up to ..mm		Notes
							Front	Rear	
<b>TOYOTA - CONTINUED</b>									
	RAV4 (XA30) 2.0 VVT-i, 2.2 D-4D 135, 2.2 D-4D 180 Front: for original struts only	06-12.12	Special-Active	Ⓒ 8645-1176	ⒸⒸ 8245-1177				
<b>Supra</b>									
	Supra (MA70) incl. Turbo	86-93	Sport	Ⓒ 8040-1063Sport	Ⓒ 8040-1064Sport				
	Supra (JZA80) 3.0i Turbo with the KONI Sport dampers the car can be lowered approx. Fr-Rr: 20-15mm	93-02	Sport Sport Kit	N4ⒸⒸⒸ▲ 30-1583Sport	N3ⒸⒸⒸ▲ 30-1584Sport	1140-4321	35	35	1,2,13
<b>SW40</b>									
	SW40	05-13	eavy Track	82-2560SP1					
<b>Yaris / Echo / Vitz</b>									
	Yaris, incl. Verso, excl. T-Sport	98-05	STR.T Sport STR.T Kit Sport Kit	Ⓒ 8750-1033 Ⓒ 8710-1403Sport	Ⓒ 8050-1053 80-2827Sport	1120-4421 1140-4421	35 35	35 35	1,2,13 1,2,13,17
	Yaris T-Sport	98-05	STR.T Sport	Ⓒ 8750-1033 Ⓒ 8710-1403Sport					
<b>4-Runner</b>									
	4-Runner (VZN 130L / LN 130L) V6 and Diesel	08.89-98	eavy Track		Ⓒ 30-1422				
<b>86</b>									
	86	12-19	Sport Sport Kit	ⒸⒸ 8741-1560LSport ⒸⒸ 8741-1560RSport	ⒸⒸ 8041-1416Sport	1140-8561	25	25	1,2,13,16
<b>TOYOTA AUSTRALIA</b>									
<b>Four Runner</b>									
	Four Runner LN61, LN63, N63, N110, LM108, LN110, RN106, RN110	86-89	eavy Track	□ 82-2317					
	NOTE: these dampers are only for vehicles raised 50mm - additional parts are needed		eavy Track	□ 82-2317	82-2294				
	NOTE: these dampers are only for vehicles raised 50mm - additional parts are needed		eavy Track	82-2293	82-2294				
	Four Runner NOTE: these dampers are only for vehicles raised 50mm - additional parts are needed	90-96	eavy Track	□ 82-2317	82-2296				
<b>Hi-Lux</b>									
	Hi-Lux 4-WD models with leaf springs NOTE: these dampers are only for vehicles raised 50mm - additional parts are needed	79-83	eavy Track	82-2293	82-2297				
	Hi-Lux 4-WD models with leaf springs N65R, N67, LN65, LN67, RN105, LN106, excl. raised suspension	84-	eavy Track		Ⓒ 30-1407				
	NOTE: these dampers are only for vehicles raised 50mm - additional parts are needed		eavy Track	82-2293	82-2294				
	Hi-Lux (RN110 / LN111) with independent front suspension	08.88-04	eavy Track	□ 82-2317					
	Hi-Lux Pickup AWD Fit vehicles with standard or raised suspension, Front Rear: 0 - 30 mm	05-14	eavy Track T RAID	82-2560SP1 88-1713	82-2561SP1 90-5410SP1				
	NOTE: these dampers are only for vehicles raised 50mm - additional parts are needed		eavy Track		82-2312				
	Hi-Lux Pickup AWD	15-	eavy Track T RAID	82-2632 88-1830	82-2633 90-5479				
<b>TRIUMPH</b>									
<b>Herald</b>									
	Herald, incl. Convertible & Estate	59-71	Classic	☞□ 80-1388	☞□ 80-1389				
<b>Vitesse</b>									
	Vitesse	62-71	Classic	☞□ 80-1388	☞□ 80-1389				
<b>GT6</b>									
	GT6 Mk I	66-68	Classic	☞□ 80-1388	☞□ 80-1389				
	GT6 Mk II	69-70	Classic	☞□ 80-1388					
	GT6 Mk III	71-73	Classic	☞□ 80-1388					
	GT6 Mk III	74-74	Classic	☞□ 80-1388	☞□ 80-1389				
<b>Spitfire</b>									
	Spitfire Mk I (Spitfire 4)	62-65	Classic	☞□ 80-1388	☞□ 80-1389				
	Spitfire Mk II	66-67	Classic	☞□ 80-1388	☞□ 80-1389				
	Spitfire Mk III	68-70	Classic	☞□ 80-1388	☞□ 80-1389				
	Spitfire Mk IV	71-74	Classic	☞□ 80-1388	☞□ 80-1389				
	Spitfire 1500	75-80	Classic	☞□ 80-1388	☞□ 80-1389				
<b>TR-series</b>									
	TR2	53-55	Classic	☞ 80-1005	△				
	TR3	55-62	Classic	☞ 80-1005	△				
	TR4	61-65	Classic	☞ 80-1005	△				
	TR4A with independent rear suspension (IRS)	65-67	Classic	☞□ 80-1784	△				
	TR5	67-69	Classic	☞□ 80-1784	△				
	TR250	68-69	Classic	☞□ 80-1784	△				
	TR6	69-76	Classic	☞□ 80-1784	△				
<b>VAUXHALL (SEE ALSO OPEL)</b>									
<b>Agila</b>									
	1.0, 1.2, 1.3 CDTi	09.07-14	STR.T STR.T Kit	Ⓒ 8750-1092L Ⓒ 8750-1092R	Ⓒ 8050-1125	1120-1601	30	30	1,2,13

MAKE		Year	product range				Lowering up to ..mm		Notes
Model							Front	Rear	
<b>VAUXHALL (SEE ALSO OPEL) - CONTINUED</b>									
<b>Astra</b>									
Astra Mk1 Hatchback, excl. GTE	80-09.88	Sport	ⓂⓄ 8641-1068Sport						
Astra Mk1 GTE	83-84	Sport	ⓂⓄ 8641-1068Sport						
Astra Mk2 Hatchback, excl. GTE Belmont Saloon	85-09.88	STR.T	Ⓞ 8650-1006						
Astra Mk2 GTE	85-09.88	Sport	ⓂⓄ 8641-1068Sport						
Astra Mk2 Hatchback, excl. GTE Belmont Saloon	09.88-90	Sport	ⓂⓄ 8641-1068Sport	ⓂⓄ 8041-1095Sport					
Astra Mk2 GTE incl. 2.0-16V	09.88-09.91	Sport	ⓂⓄ 8641-1068Sport	ⓂⓄ 8041-1095Sport					
Astra Mk3 Hatchback / Saloon, excl. GSi / GSi-16V	09.91-97	STR.T	Ⓞ 8650-1004	Ⓞ 8050-1030					
		Sport		ⓂⓄ 8010-1032Sport					
Astra Mk3 GSi-16V	09.91-97	STR.T	Ⓞ 8650-1004						
		Sport	ⓂⓄ 8610-1283Sport	ⓂⓄ 8010-1032Sport					
Astra Mk4 Sedan/Hatchback, incl. Sportp., excl. OPC	98-04	STR.T	Ⓞ 8750-1028L Ⓞ 8750-1028R	Ⓞ 8050-1048					
		Sport	ⓂⓂ▲ 8710-1369LSport ⓂⓂ▲ 8710-1369RSport	80-2796Sport					
Astra Mk4 Caravan, incl. Sportpack	98-04	STR.T	Ⓞ 8750-1028L Ⓞ 8750-1028R	Ⓞ 8050-1084					
		Sport	ⓂⓂ▲ 8710-1369LSport ⓂⓂ▲ 8710-1369RSport						
Astra Mk4 OPC 2.0-16V	00-04	STR.T	Ⓞ 8750-1028L Ⓞ 8750-1028R	Ⓞ 8050-1048					
		Sport	ⓂⓂ▲ 8710-1369LSport ⓂⓂ▲ 8710-1369RSport	80-2796Sport					
Astra Mk5 Sedan / Hatchback 1.4, 1.6, 1.8 excl. IDS-Plus suspension	04-09	STR.T	Ⓞ 8750-1085L Ⓞ 8750-1085R	Ⓞ 8250-1025					
Astra Mk5 Sedan / Hatchback 1.7CDTi, 1.9CDTi, 2.0T excl. IDS-Plus suspension	04-09	STR.T	Ⓞ 8750-1085L Ⓞ 8750-1085R	Ⓞ 8250-1025					
Astra Mk5 Wagon excl. IDS-Plus suspension and self-levelling systems	04-10	STR.T	Ⓞ 8750-1085L Ⓞ 8750-1085R						
Astra Mk6 Sedan & Sports Tourer excl. GTC, OPC, V R, IDS-Plus suspension and self-levelling systems	09-15	Sport	ⓂⓄ 8741-1568LSport ⓂⓄ 8741-1568RSport	Ⓞ 8240-1293Sport					
		Sport Kit						I.D.	
Astra Mk6 GTC excl. Flexride, OPC, V R	09-17	Sport	ⓂⓄ 8741-1585LSport ⓂⓄ 8741-1585RSport	Ⓞ 8240-1301Sport					
		Sport Kit						I.D.	
<b>Calibra</b>									
Calibra 2.0i, 2.0i-16V, incl. 4WD	90-97	Sport	ⓂⓄ 8610-1263Sport	ⓂⓄ 8210-1158Sport					
<b>Carlton</b>									
Carlton Mk III Saloon excl. 3000	87-93	Sport		80-2591Sport					
<b>Cavalier</b>									
Cavalier Saloon / Hatchback / Coupé	76-81	Classic	☒☐ 80-2275						
		STR.T	Ⓞ 8250-1014	Ⓞ 8250-1013					
		Sport	☐ 82-1886Sport	☐ 82-1801Sport					
Cavalier 1.4, 1.6, 1.7 D/TD, 1.8, 2.0, 2.5-V6	09.88-95	Sport	ⓂⓄ 8610-1263Sport	ⓂⓄ 8041-1095Sport					
Cavalier SRi 2.0i-16V, incl. 4WD with independent rear suspension (IRS)	89-95	Sport	ⓂⓄ 8610-1263Sport	80-2591Sport					
Cavalier 1.8, 2.0 GL 4WD with independent rear suspension (IRS)	89-95	Sport	ⓂⓄ 8610-1263Sport	80-2591Sport					
Cavalier 2.0-16V Turbo 4WD	91-95	Sport	ⓂⓄ 8610-1263Sport	80-2591Sport					
<b>Chevette</b>									
Chevette Hatchback	75-84	Classic	☒☐ 80-2275	☒ 80-1997					
		STR.T	Ⓞ 8250-1014						
		Sport	☐ 82-1886Sport	☐ 80-1997Sport					
Chevette Notchback Saloon	76-84	Classic	☒☐ 80-2275						
		STR.T	Ⓞ 8250-1014						
		Sport	☐ 82-1886Sport						
<b>Corsa</b>									
Corsa 1.2, 1.4, 1.5 D	93-00	STR.T	Ⓞ 8750-1021	Ⓞ 8050-1027					
		Sport	ⓂⓄ 8710-1276Sport						
Corsa 1.6 GSi, SRi, Sport	93-00	STR.T	Ⓞ 8750-1021	Ⓞ 8050-1027					
		Sport	ⓂⓄ 8710-1276Sport						
Corsa, incl. GSi	10.00-06	STR.T	Ⓞ 8750-1034L Ⓞ 8750-1034R	Ⓞ 8050-1054					
<b>Combo</b>									
Combo Van, incl. Brava	93-01	STR.T	Ⓞ 8750-1021						
		Sport	ⓂⓄ 8710-1276Sport						
<b>Frontera</b>									
Frontera 2-door (with leaf springs rear)	91-95	easy Track	Ⓞ 30-1365						
Frontera 4-door (with leaf springs rear)	91-95	easy Track	Ⓞ 30-1365	Ⓞ 30-1500					
Frontera, incl. Sport with coil springs rear	95-09.98	easy Track	Ⓞ 30-1565	Ⓞ 30-1566					
Frontera II	10.98-04	easy Track	Ⓞ 30-1663	Ⓞ 30-1664					

MAKE		Year	product range				Lowering up to ..mm		Notes
Model							Front	Rear	
<b>VAUXHALL (SEE ALSO OPEL) - CONTINUED</b>									
<b>Insignia</b>									
	Insignia A (G09) excl. Tourer excl. V R, excl. Flexride, excl. 4WD	08-02-17	Sport			Ⓒ ▲ 8240-1291Sport			
<b>Monterey</b>									
	Monterey	92-03-95	eavy Track		Ⓒ 30-1565	Ⓒ 30-1566			
	Monterey	04-95-98	eavy Track			Ⓒ 30-1566			
<b>Nova</b>									
	Nova, incl. 1.6 GTE	83-91	STR.T		Ⓒ 8750-1021				
			Sport		Ⓜ 8710-1276Sport				
	Nova, incl. 1.6 GTE, excl. TR	92-93	STR.T		Ⓒ 8750-1021				
			Sport		Ⓜ 8710-1276Sport				
<b>Omega</b>									
	Omega Saloon 2.0, 2.0-16V Front: for original struts only	94-99	Sport		Ⓜ ◆ 8610-1315Sport	Ⓝ 80-2591Sport			
	Omega Saloon 2.5TD, 2.5-V6, 3.0-V6 Front: for original struts only	94-03	Sport		Ⓜ ◆ 8610-1315Sport	Ⓝ 80-2591Sport			
	Omega Estate 2.0, 2.0-16V Front: for original struts only	94-03	Sport		Ⓜ ◆ 8610-1315Sport				
	Omega Estate 2.5TD, 2.5-V6, 3.0-V6 Front: for original struts only	94-03	Sport		Ⓜ ◆ 8610-1315Sport				
<b>Senator</b>									
	Senator 2.6i, 3.0i	88-93	Sport			Ⓝ 80-2591Sport			
<b>Tigra</b>									
	Tigra 1.4, 1.6 Front: Before fitting the dampers have to be adjusted one full turn	95-99	STR.T		Ⓒ 8750-1021	Ⓒ 8050-1027			
			Sport		Ⓜ 8710-1276Sport				
	Tigra TwinTop 1.4, 1.8, 1.3CDTi	04-09	STR.T		Ⓒ 8750-1034L	Ⓒ 8050-1054			
					Ⓒ 8750-1034R				
<b>Vectra</b>									
	Vectra Sedan 1.6, 1.6-16V, 1.8	96-02	Special-Active			Ⓒ 8045-1160			
	2.5 V6, 1.7TD, 2.0Di, 2.0DTi		Special-Active			Ⓒ 8045-1160			
	Vectra Estate	96-02	Special-Active			Ⓒ 8045-1160			
<b>Zafira</b>									
	Zafira A excl. OPC	99-04	STR.T		Ⓒ 8750-1028L	Ⓒ 8050-1084			
					Ⓒ 8750-1028R				
			Sport		Ⓜ ▲ 8710-1369LSport				
					Ⓜ ▲ 8710-1369RSport				
<b>VOLGA</b>									
<b>series 3102, 31029, 31022-2.4</b>									
	series 3102, 31029, 31022-2.4	82-94	Classic		Ⓜ 80-1689	Ⓜ 80-1690			
<b>VOLKSWAGEN</b>									
<b>Amarok</b>									
	Amarok 2WD & 4WD Fit vehicles with standard or raised suspension, Front Rear: 0 - 30 mm	09-19	eavy Track		82-2595	82-2596			
<b>Arteon</b>									
	Arteon 1.5TSi, 2.0TDi	04-17-	Special-Active		I.D.	I.D.			
			Sport		I.D.	I.D.			
			Sport Kit						I.D.
<b>Beetle</b>									
	1200	53-59	Classic		Ⓜ 80-1349				
	1200	60-65	Classic		Ⓜ 80-1349	Ⓜ 80-1350			
			Sport			80-1350Sport			
	1200 A / 1300 / 1500	65-70	Classic		Ⓜ □ 80-1787	Ⓜ 80-1350			
			Sport			80-1350Sport			
	1200 / 1300 with single joint rear axle	71-77	Classic		Ⓜ □ 80-1787	Ⓜ 80-1350			
			Sport			80-1350Sport			
	1200 (made in Mexico) with single joint rear axle	-	Classic		Ⓜ □ 80-1787	Ⓜ 80-1350			
			Sport			80-1350Sport			
	1200 A / 1300 / 1500 with double joint rear axle (Canada .S.A. model)	69-77	Classic		Ⓜ □ 80-1787	Ⓜ 80-2149			
			Sport			80-2149Sport			
	1300 / 1500 Sportomatic with double joint rear axle	68-70	Classic		Ⓜ □ 80-1787	Ⓜ 80-2149			
			Sport			80-2149Sport			
	1300 Automatik with double joint rear axle	71-73	Classic		Ⓜ □ 80-1787	Ⓜ 80-2149			
			Sport			80-2149Sport			
	1302 / 1303	70-73	Classic		Ⓜ 86-1741	Ⓜ 80-2149			
			Sport			80-2149Sport			
	1303	74-74	Classic		Ⓜ 80-2149	Ⓜ 80-2149			
			Sport			80-2149Sport			
	1303 / Super Beetle (USA)	75-80	Classic		Ⓜ 86-1980	Ⓜ 80-2149			
			Sport		Ⓜ Ⓒ 8641-1038Sport	80-2149Sport			
<b>Karmann Ghia</b>									
	Karmann Ghia (Type 14)	60-65	Classic		Ⓜ 80-1349	Ⓜ 80-1350			
			Sport			80-1350Sport			
	Karmann Ghia (Type 14)	65-70	Classic		Ⓜ □ 80-1787	Ⓜ 80-1350			
			Sport			80-1350Sport			
	Karmann Ghia (Type 14) with single joint rear axle	71-77	Classic		Ⓜ □ 80-1787	Ⓜ 80-1350			
			Sport			80-1350Sport			

MAKE		Year	product range				Lowering up to ..mm		Notes
Model							Front	Rear	
<b>VOLKSWAGEN - CONTINUED</b>									
Karmann Ghia (Type 14) with double joint rear axle		69-77	Classic Sport	80-1787	80-2149 80-2149Sport				
<b>Bora</b>									
Bora excl. 4-Motion		11.98-05	Special-Active	8745-1029	8045-1083				
Front axle load up to 910 kg			Special	87-2571	80-2761				
Front axle load as from 911 kg			STR.T	8750-1002	8050-1001				
			Sport	8710-1337Sport	80-2761Sport				
			STR.T Kit		1120-5261	35	35	1,2,13	
			Sport Kit		1140-5261	35	35	1,2,13,17	
			STR.T Kit		1120-5262	35	35	1,2,13	
			Sport Kit		1140-5262	35	35	1,2,13,17	
Bora 1.8, 2.0, 2.3-V5, 2.8-V6, 1.9TDi 4-Motion		99-00	Special-Active	8745-1030	8245-1032				
Front axle load up to 910 kg			STR.T	8750-1002	8050-1086				
Front axle load as from 911 kg			Sport	8710-1337Sport	80-2806Sport				
			STR.T Kit			1120-4381	25	25	1,2,13
			Sport Kit		1140-4381	25	25	1,2,13,17	
Bora 1.8, 2.0, 2.3-V5, 2.8-V6, 1.9TDi 4-Motion Front: with anti-roll bar attached to spring seat		00-02	Special-Active	8745-1030	8245-1032				
Front: with anti-roll bar attached to spring seat			STR.T	8750-1063	8050-1086				
			Sport	8710-1385Sport	80-2806Sport				
			STR.T Kit			1120-4382	25	25	1,2,13
			Sport Kit		1140-4382	25	25	1,2,13,17	
Bora Variant excl. 4-Motion		04.99-05	Special	87-2571					
Front axle load up to 910 kg			STR.T	8750-1002	8050-1017				
Front axle load as from 911 kg			Sport	8710-1337Sport	80-2815Sport				
Bora Variant		04.99-04	STR.T Kit			1120-4391	35	35	1,2,13
Front axle load up to 910 kg			Sport Kit			1140-4391	35	35	1,2,13,17
Bora Variant		04.99-05	STR.T Kit			1120-4392	35	35	1,2,13
Front axle load as from 911 kg			Sport Kit			1140-4392	35	35	1,2,13,17
Bora Variant 1.9TDi, 2.3-V5 4-Motion		00-04	Special-Active	8745-1030	8245-1032				
Front: with anti-roll bar attached to spring seat			STR.T	8750-1063	8050-1086				
			Sport	8710-1385Sport	80-2806Sport				
			STR.T Kit			1120-4382	25	25	1,2,13
			Sport Kit		1140-4382	25	25	1,2,13,17	
<b>Caddy</b>									
Caddy 1		83-92	Classic	86-1919					
Front: as from 1992, only for non-sealed struts without dent in housing to clear the tire			STR.T	8650-1005					
Front: for original struts 50 mm only			Sport	86-1919Sport					
Front: for original struts 55 mm only			Sport	8641-1048Sport					
Caddy 2		96-04	STR.T	8750-1001					
Caddy 3, 4, excl. 4-Motion		04-18	STR.T	8750-1006					
Front: for original struts 50 mm only			Special	8710-1432Sport	80-2879				
Front: for original struts 55 mm only			STR.T	8750-1005					
		Special	8710-1431Sport	80-2879					
<b>California / Multivan</b>									
California / Multivan Camper (T5,T6 based) Front: only for clamped struts (no bracket) excl. DCC		04.03-	Special	87-2645	82-2542				
ACTIVE technology inside for superior comfort and handling			Special-Active	8705-1392	8205-1009				
<b>Corrado</b>									
Corrado 16V, GTi, G60 Front: as from 1992, only for non-sealed struts without dent in housing to clear the tire		88-95	Sport		M3 80-2587Sport				
Front: for sealed or non-sealed OE struts with dent in housing to clear the tire			Sport	8641-1198Sport	T1   8041-1108Sport				
			Sport Kit			1140-7061	30	30	1,2,13,16
			Coil-over Kit			1150-5002-1	60	50	1,2,13,16,21,22
			STR.T	8750-1009					
			Sport		M3 80-2587Sport				
			Sport	8741-1259Sport	T1   8041-1108Sport				
Corrado VR6		91-95	STR.T	8750-1009					
Front: as from 1992, only for non-sealed struts without dent in housing to clear the tire			Sport			M3 80-2587Sport			
Front: for sealed or non-sealed OE struts with dent in housing to clear the tire			Sport	8741-1259Sport	T1   8041-1108Sport				
			Sport Kit			1140-8721	30	30	1,2,13,16
			Coil-over Kit		1150-5002-1	60	50	1,2,13,16,21,22	
<b>Derby</b>									
Derby		75-81	Sport	86-1922Sport	80-2315Sport				
<b>Eos</b>									
Eos 1.6 FSi, 2.0 FSi/TFSi, 3.2V6, 2.0TDi Front axle load up to 1070 kg		05.06-13	Special-Active	8745-1038					
Front: with anti-roll bar attached to spring seat			Sport	8710-1431Sport					26
<b>Fox</b>									
Fox		05-11	Special-Active	8745-1069	8045-1070				
Front axle load up to 830 kg			STR.T	8750-1004	8050-1005				
			Sport	8710-1404Sport	80-2830Sport				
			STR.T Kit			1120-3331	35	35	1,2,13
			Sport Kit		1140-3331	35	35	1,2,13,17	
<b>Golf 1</b>									
Golf 1		74-83	Classic	86-1919					
Front: as from 1992, only for non-sealed struts without dent in housing to clear the tire			STR.T	8650-1005	8050-1010				
Front: for original struts 50 mm only			Sport	86-1919Sport	80-2307Sport				
Front: for original struts 55 mm only			Sport	8641-1048Sport	T3   8041-1101Sport				



MAKE		Year	product range				Lowering up to ..mm		Notes
Model							Front	Rear	
<b>VOLKSWAGEN - CONTINUED</b>									
Golf 1 Cabrio	79-93	Classic	Ⓒ 86-1919						
		STR.T	Ⓒ 8650-1005	Ⓒ 8050-1010					
Golf 1 Diesel	78-83	Sport	86-1919Sport	80-2307Sport					
		STR.T	Ⓒ 8650-1005	Ⓒ 8050-1010					
Golf 1 GTI	76-83	Sport	Ⓒ 8641-1048Sport	T3ⒸⒺⒻⒼⒽⒾⒿⓀ 8041-1101Sport					
		STR.T	Ⓒ 8650-1005	Ⓒ 8050-1010					
Front axle load as from 661kg, rear axle load up to 571kg		Sport	86-1919Sport	80-2307Sport					
		STR.T Kit			1120-5403	25	40	1, 2, 13	
Front axle load as from 661kg, rear axle load as from 571kg		Sport Kit			1140-5403	25	40	1, 2, 13, 16	
		STR.T Kit			1120-5404	25	40	1, 2, 13	
Sport Kit					1140-5404	25	40	1, 2, 13, 16	
<b>Golf 2</b>									
Golf 2 C, CL, GL, GT	09.83-91	STR.T	Ⓒ 8750-1008	Ⓒ 8050-1007					
		Sport	Ⓒ 8741-1258Sport	M3ⒸⒺⒻ 80-2542Sport					
		STR.T Kit			1120-5412	35	35	1,2,13	
		Sport Kit			1140-5412	35	35	1,2,13,17	
Coil-over Kit					1150-5001-1	65	55	16,21,22	
Golf 2 Diesel and Turbo-Diesel	09.83-91	STR.T	Ⓒ 8750-1008	Ⓒ 8050-1007					
		Sport	Ⓒ 8741-1258Sport	M3ⒸⒺⒻ 80-2542Sport					
Coil-over Kit					1150-5001-1	65	55	1,2,13,16,21,22	
Golf 2 GTI 8V	09.83-91	STR.T	Ⓒ 8750-1008	Ⓒ 8050-1007					
		Sport	Ⓒ 8741-1258Sport	M3ⒸⒺⒻ 80-2542Sport					
		STR.T Kit			1120-5412	35	35	1,2,13	
		Sport Kit			1140-5412	35	35	1,2,13,17	
Coil-over Kit					1150-5001-1	65	55	1,2,13,16,21,22	
Golf 2 GTI 16V	86-91	STR.T	Ⓒ 8750-1008	Ⓒ 8050-1008					
		Sport	Ⓒ 8741-1258Sport	M3ⒸⒺⒻ 80-2587Sport					
		STR.T Kit			1120-6322	30	30	1,2,13	
		Sport Kit			1140-6322	30	30	1,2,13,17	
Coil-over Kit					1150-5001-1	65	55	1,2,13,16,21,22	
Golf 2 GTI G60	90-91	STR.T		Ⓒ 8050-1008					
		Sport	Ⓒ 8641-1198Sport	M3ⒸⒺⒻ 80-2587Sport					
Golf 2 Syncro 4WD	86-91	STR.T	Ⓒ 8750-1008						
		Sport	Ⓒ 8741-1258Sport						
Golf 2 GTI G60 Syncro 4WD	90-91	Sport	Ⓒ 8641-1198Sport						
<b>Golf 3</b>									
Golf 3 1.4, 1.6, 1.8GT, excl. Automatic cars with 4-bolt wheels	08.91-09.97	STR.T	Ⓒ 8750-1008	Ⓒ 8050-1007					
		Sport	Ⓒ 8741-1258Sport	M3ⒸⒺⒻ 80-2542Sport					
		Coil-over Kit			1150-5002-1	65	55	1,4,13,16,21,22	
Golf 3 1.9D, 1.9TD cars with 4-bolt wheels	08.91-09.97	STR.T	Ⓒ 8750-1008	Ⓒ 8050-1007					
		Sport	Ⓒ 8741-1258Sport	M3ⒸⒺⒻ 80-2542Sport					
		Coil-over Kit			1150-5002-1	65	55	1,4,13,16,21,22	
Golf 3 GTI (8V, 16V, TDI) & VR6, excl. Syncro cars with 5-bolt wheels (Plus-suspension)	08.91-09.97	STR.T	Ⓒ 8750-1009	Ⓒ 8050-1008					
		Sport	Ⓒ 8741-1259Sport	M3ⒸⒺⒻ 80-2587Sport					
		STR.T Kit			1120-8722	30	30	13, for VR6 only	
		Sport Kit			1140-8722	30	30	13, for VR6 only	
Coil-over Kit					1150-5002-1	65	55	16,21,22	
Golf 3 Cabrio cars with 4-bolt wheels	93-02	STR.T	Ⓒ 8750-1008	Ⓒ 8050-1008					
		Sport	Ⓒ 8741-1258Sport	M3ⒸⒺⒻ 80-2587Sport					
		Coil-over Kit			1150-5002-1	65	55	16,21,22	
Golf 3 Variant, excl. Syncro cars with 4-bolt wheels	93-99	STR.T	Ⓒ 8750-1008						
		Sport	Ⓒ 8741-1258Sport						
<b>Golf 4</b>									
Golf 4 if equipped with OE Sport Suspension: KONI Special is excluded	10.97-03	Special-Active	Ⓒ 8745-1029	Ⓒ 8045-1083					
		Special	▲ 87-2571	▲ 80-2761					
Front axle load up to 910 kg		STR.T	Ⓒ 8750-1002	Ⓒ 8050-1001					
		Sport	Ⓒ 8710-1337Sport	80-2761Sport					
STR.T Kit					1120-5261	35	35	1,2,13	
					1140-5261	35	35	1,2,13,17	
Sport Kit					1120-5262	35	35	1,2,13	
					1140-5262	35	35	1,2,13,17	
Golf 4 GTI (1.8T, 2.3 V5, 1.9 TDI)	10.97-03	Special-Active	Ⓒ 8745-1029	Ⓒ 8045-1083					
		STR.T	Ⓒ 8750-1002	Ⓒ 8050-1001					
		Sport	Ⓒ 8710-1337Sport	80-2761Sport					
		STR.T Kit			1120-5262	35	35	1,2,13	
Sport Kit			1140-5262	35	35	1,2,13,17			
Golf 4 Variant excl. 4-Motion	04.99-04	Special	▲ 87-2571						
		Special-Active	Ⓒ 8745-1029						
		STR.T	Ⓒ 8750-1002	Ⓒ 8050-1017					
		Sport	Ⓒ 8710-1337Sport	80-2815Sport					
STR.T Kit					1120-4391	35	35	1,2,13	
					1140-4391	35	35	1,2,13,17	
Sport Kit									

MAKE		Year	product range				Lowering up to ..mm		Notes
Model							Front	Rear	
<b>VOLKSWAGEN - CONTINUED</b>									
Front axle load as from 911 kg			STR.T Kit			1120-4392	35	35	1,2,13
Sport Kit						1140-4392	35	35	1,2,13,17
<b>Golf 4 4-Motion 1.8T, 1.9TDi, 2.3-V5</b>		04-99-99	Special-Active	Ⓢ 8745-1030		Ⓢ 8245-1032			
STR.T				Ⓢ 8750-1002		Ⓢ 8050-1086			
Sport				Ⓢ 8710-1337Sport		80-2806Sport			
STR.T Kit						1120-4381	25	25	1,2,13
Sport Kit						1140-4381	25	25	1,2,13,17
<b>Golf 4 4-Motion 1.8T, 1.9TDi, 2.3-V5</b> Front: with anti-roll bar attached to spring seat		00-03	Special-Active	Ⓢ 8745-1030		Ⓢ 8245-1032			
STR.T				Ⓢ 8750-1063		Ⓢ 8050-1086			
Sport				Ⓢ 8710-1385Sport		80-2806Sport			
STR.T Kit						1120-4382	25	25	1,2,13
Sport Kit					1140-4382	25	25	1,2,13,17	
<b>Golf 4 4-Motion 2.8-V6</b> Front: with anti-roll bar attached to spring seat		99-03	Special-Active	Ⓢ 8745-1030		Ⓢ 8245-1032			
STR.T				Ⓢ 8750-1063		Ⓢ 8050-1086			
Sport				Ⓢ 8710-1385Sport		80-2806Sport			
STR.T Kit						1120-4382	25	25	1,2,13
Sport Kit					1140-4382	25	25	1,2,13,17	
<b>Golf 4 Variant 1.9TDi 4-Motion</b>		99-04	Special-Active	Ⓢ 8745-1030		Ⓢ 8245-1032			
STR.T				Ⓢ 8750-1063		Ⓢ 8050-1086			
Sport				Ⓢ 8710-1385Sport		80-2806Sport			
<b>Golf 5</b>									
<b>Golf 5, excl. GTI, 4-Motion and Cross Golf</b> Front: for original struts 55 mm only		10-03-08	Special-Active	Ⓢ 8745-1006		Ⓢ 8045-1084			
STR.T				Ⓢ 8750-1005		Ⓢ 8050-1006			
Sport				Ⓢ 8710-1431Sport		80-2859Sport			
Front axle load up to 1020 kg			STR.T Kit			1120-2611	35	35	1,2,13
Sport Kit					1140-2611	35	35	1,2,13,17	
Coil-over Kit					1150-5080-1	60	50	9,17,21,23 NO T V	
Front axle load as from 1021 kg			STR.T Kit			1120-2612	35	35	1,2,13
Sport Kit					1140-2612	35	35	1,2,13,17	
Coil-over Kit					1150-5080-1	60	50	9,17,21,23 NO T V	
Front: for original struts 50 mm only			STR.T	Ⓢ 8750-1006		Ⓢ 8050-1006			
Sport			Ⓢ 8710-1432Sport		80-2859Sport				
Front axle load up to 1020 kg			STR.T Kit			1120-2613	35	35	1,2,13
Sport Kit					1140-2613	35	35	1,2,13,17	
Front axle load as from 1021 kg			STR.T Kit			1120-2614	35	35	1,2,13
Sport Kit					1140-2614	35	35	1,2,13,17	
<b>Golf 5 GT Sport, GTI</b> Front: for original struts 55 mm only		04-08	Special-Active	Ⓢ 8745-1225		Ⓢ 8045-1226			
STR.T				Ⓢ 8750-1005		Ⓢ 8050-1006			
Sport				Ⓢ 8710-1431Sport		80-2859Sport			
STR.T Kit						1120-1761	40	40	1,2,13
Sport Kit					1140-1761	40	40	1,2,13,17	
Coil-over Kit					1150-5080-1	60	50	9,17,21,23 NO T V	
<b>Golf 5 4-Motion (excl. R32)</b> Front: for original struts 55 mm only		10-04-08	Special-Active	Ⓢ 8745-1038		Ⓢ 8045-1084			
STR.T				Ⓢ 8750-1005		Ⓢ 8050-1006			
Sport				Ⓢ 8710-1431Sport		80-2859Sport			
Coil-over Kit						1150-5080-1	60	50	7,21,23 NO T V
<b>Golf 5 R32</b>		05-08	Special-Active	Ⓢ 8745-1038		Ⓢ 8045-1085			
Sport				Ⓢ 8741-1488Sport		Ⓢ 8040-1352Sport			
Sport Kit						1140-1763	20-25	20-25	1,2,13,17
<b>Golf 5 Plus, excl. Cross Golf</b> Front: for original struts 55 mm only		05-09	Special-Active	Ⓢ 8745-1038		Ⓢ 8045-1084			
STR.T				Ⓢ 8750-1005		Ⓢ 8050-1006			
Sport				Ⓢ 8710-1431Sport		80-2859Sport			
Front axle load up to 1020 kg			STR.T Kit			1120-2611	35	35	1,2,13
Sport Kit					1140-2611	35	35	1,2,13,17	
Coil-over Kit					1150-5080-1	60	50	17,21,23 NO T V	
Front axle load as from 1021 kg			STR.T Kit			1120-2612	35	35	1,2,13
Sport Kit					1140-2612	35	35	1,2,13,17	
Coil-over Kit					1150-5080-1	60	50	17,21,23 NO T V	
Front: for original struts 50 mm only			STR.T	Ⓢ 8750-1006		Ⓢ 8050-1006			
Sport			Ⓢ 8710-1432Sport		80-2859Sport				
Front axle load up to 1020 kg			STR.T Kit			1120-2613	35	35	1,2,13
Sport Kit					1140-2613	35	35	1,2,13,17	
Front axle load as from 1021 kg			STR.T Kit			1120-2614	35	35	1,2,13
Sport Kit					1140-2614	35	35	1,2,13,17	
<b>Golf 5 Variant</b> Front: for original struts 55 mm only		07-09	Special-Active	Ⓢ 8745-1038		Ⓢ 8045-1084			
STR.T				Ⓢ 8750-1005		Ⓢ 8050-1006			
Sport				Ⓢ 8710-1431Sport		80-2859Sport			
Front axle load up to 1020 kg			STR.T Kit			1120-2611	35	35	1,2,13
Sport Kit					1140-2611	35	35	1,2,13,17	
Front axle load as from 1021 kg			STR.T Kit			1120-2612	35	35	1,2,13
Sport Kit					1140-2612	35	35	1,2,13,17	
Front: for original struts 50 mm only			STR.T	Ⓢ 8750-1006		Ⓢ 8050-1006			
Sport			Ⓢ 8710-1432Sport		80-2859Sport				
Front axle load up to 1020 kg			STR.T Kit			1120-2613	35	35	1,2,13
Sport Kit					1140-2613	35	35	1,2,13,17	

MAKE		Year	product range				Lowering up to ..mm		Notes
Model							Front	Rear	
<b>VOLKSWAGEN - CONTINUED</b>									
Front axle load as from 1021 kg			STR.T Kit			1120-2614	35	35	1,2,13
			Sport Kit			1140-2614	35	35	1,2,13,17
<b>Golf 6</b>									
Golf 6, excl. GTI, 4-Motion & DCC Susp. Front: for original struts 55 mm only		08-12	Special-Active	© 8745-1006	Ⓝ 8045-1084				
			STR.T	© 8750-1005	Ⓝ 8050-1006				
			Sport	Ⓜ 8710-1431Sport	Ⓝ 80-2859Sport				
Front axle load up to 980 kg			STR.T Kit			1120-0080	35	35	1,2,13
			Sport Kit			1140-0080	35	35	1,2,13,17
			Coil-over Kit			1150-5080-1	60	50	9,17,21,23 NO T V
Front axle load as from 981 kg, up to 1020 kg			STR.T Kit			1120-0081	35	35	1,2,13
			Sport Kit			1140-0081	35	35	1,2,13,17
			Coil-over Kit			1150-5080-1	60	50	9,17,21,23 NO T V
Front axle load as from 1021 kg			STR.T Kit			1120-0082	35	35	1,2,13
			Sport Kit			1140-0082	35	35	1,2,13,17
			Coil-over Kit			1150-5080-1	60	50	9,17,21,23 NO T V
Front: for original struts 50 mm only		STR.T	© 8750-1006	Ⓝ 8050-1006					
		Sport	Ⓜ 8710-1432Sport	Ⓝ 80-2859Sport					
Front axle load up to 980 kg		STR.T Kit			1120-0085	35	35	1,2,13	
		Sport Kit			1140-0085	35	35	1,2,13,17	
Front axle load as from 981 kg, up to 1020 kg		STR.T Kit			1120-0086	35	35	1,2,13	
		Sport Kit			1140-0086	35	35	1,2,13,17	
Front axle load as from 1021 kg		STR.T Kit			1120-0087	35	35	1,2,13	
		Sport Kit			1140-0087	35	35	1,2,13,17	
Golf 6 GTI & GTD excl. DCC (Dynamic Chassis Control)		09-12	Special-Active	© 8745-1225	Ⓝ 8045-1226				
			STR.T	© 8750-1005	Ⓝ 8050-1006				
			Sport	Ⓜ 8710-1431Sport	Ⓝ 80-2859Sport				
			STR.T Kit			1120-9881	25-30	25-30	1,2,13
		Sport Kit			1140-9881	25-30	25-30	1,2,13,17	
		Coil-over Kit			1150-5080-1	40	35	17,21,23 NO T V	
Golf 6 R(20) excl. DCC (Dynamic Chassis Control)		09-09-12	Special-Active	© 8745-1038	© 8045-1085				
		Sport	ⓂⓃ 8741-1488Sport	© 8040-1352Sport					
		Sport Kit			1140-9481	20	20	1,2,13,17	
Golf 6 Plus, excl. Cross Golf Front: for original struts 55 mm only		09-13	Special-Active	© 8745-1038	© 8045-1084				
			STR.T	© 8750-1005	© 8050-1006				
			Sport	Ⓜ 8710-1431Sport	80-2859Sport				
Front axle load up to 980 kg			STR.T Kit			1120-0080	35	35	1,2,13
			Sport Kit			1140-0080	35	35	1,2,13,17
			Coil-over Kit			1150-5080-1	60	50	17,21,23 NO T V
Front axle load as from 981 kg, up to 1020 kg			STR.T Kit			1120-0081	35	35	1,2,13
			Sport Kit			1140-0081	35	35	1,2,13,17
			Coil-over Kit			1150-5080-1	60	50	17,21,23 NO T V
Front axle load as from 1021 kg			STR.T Kit			1120-0082	35	35	1,2,13
			Sport Kit			1140-0082	35	35	1,2,13,17
			Coil-over Kit			1150-5080-1	60	50	17,21,23 NO T V
Front: for original struts 50 mm only		Special-Active		© 8045-1084					
		STR.T	© 8750-1006	© 8050-1006					
		Sport	Ⓜ 8710-1432Sport	80-2859Sport					
Front axle load up to 980 kg		STR.T Kit			1120-0085	35	35	1,2,13	
		Sport Kit			1140-0085	35	35	1,2,13,17	
Front axle load as from 981 kg, up to 1020 kg		STR.T Kit			1120-0086	35	35	1,2,13	
		Sport Kit			1140-0086	35	35	1,2,13,17	
Front axle load as from 1021 kg		STR.T Kit			1120-0087	35	35	1,2,13	
		Sport Kit			1140-0087	35	35	1,2,13,17	
Golf 6 Variant Front: for original struts 55 mm only		09-13	Special-Active	© 8745-1038	© 8045-1084				
			STR.T	© 8750-1005	© 8050-1006				
			Sport	Ⓜ 8710-1431Sport	80-2859Sport				
Front axle load up to 1020 kg			STR.T Kit			1120-0083	35	35	1,2,13
			Sport Kit			1140-0083	35	35	1,2,13,17
Front axle load as from 1021 kg			STR.T Kit			1120-0084	35	35	1,2,13
			Sport Kit			1140-0084	35	35	1,2,13,17
Front: for original struts 50 mm only			STR.T	© 8750-1006	© 8050-1006				
			Sport	Ⓜ 8710-1432Sport	80-2859Sport				
Front axle load up to 1020 kg			STR.T Kit			1120-0088	35	35	1,2,13
			Sport Kit			1140-0088	35	35	1,2,13,17
Front axle load as from 1021 kg			STR.T Kit			1120-0089	35	35	1,2,13
		Sport Kit			1140-0089	35	35	1,2,13,17	
Golf 6 Cabrio Vehicles with standard suspension. Front: for original struts 55 mm only		11-13	Special-Active	© 8745-1006	© 8045-1084				
			Sport	Ⓜ 8710-1431Sport	© 8040-1371Sport				
			Sport	Ⓜ 8710-1432Sport	© 8040-1371Sport				
Vehicles with standard suspension. Front: for original struts 50 mm only									
Vehicles with factory sports suspension. Front: for original struts 55 mm only			Special-Active	© 8745-1225	© 8045-1226				
			Sport	Ⓜ 8710-1431Sport	© 8040-1371Sport				
<b>Golf 7</b>									
Golf 7 excl. DCC, GTI/GTD/GTE/R Front: for original struts 50 mm only Rear: only for cars with torsion-beam rear suspension		11.12-06.19	Special-Active	© 8745-1324	© 8245-1326				
			STR.T	© 8750-1115	© 8250-1044				
			Sport	ⓂⓃ 8741-1571Sport	© 8240-1296Sport				

MAKE	Year	product range				Lowering up to ..mm		Notes
						Front	Rear	
<b>VOLKSWAGEN - CONTINUED</b>								
Front axle load up to 930 kg		STR.T Kit			1120-8435	35	35	1,2,13
		Sport Kit			1140-8435	35	35	1,2,13,17
Front axle load as from 931 kg, up to 1010 kg		STR.T Kit			1120-8433	35	35	1,2,13
		Sport Kit			1140-8433	35	35	1,2,13,17
Front axle load as from 1011 kg		STR.T Kit			1120-8434	35	35	1,2,13
		Sport Kit			1140-8434	35	35	1,2,13,17
Front: for original struts 50 mm only Rear: only for cars with multi-link suspension		Special-Active	Ⓢ 8745-1324	Ⓢ 8245-1327				
		STR.T	Ⓢ 8750-1115	Ⓢ 8250-1050				
		Sport	ⓈⓈ 8741-1571Sport	Ⓢ 8240-1297Sport				
Front axle load up to 930 kg		STR.T Kit			1120-8436	35	35	1,2,13
		Sport Kit			1140-8436	35	35	1,2,13,17
Front axle load as from 931 kg, up to 1010 kg		STR.T Kit			1120-8431	35	35	1,2,13
		Sport Kit			1140-8431	35	35	1,2,13,17
Front axle load as from 1011 kg		STR.T Kit			1120-8432	35	35	1,2,13
		Sport Kit			1140-8432	35	35	1,2,13,17
Front: for original struts 55 mm only Rear: only for cars with torsion-beam rear suspension		Special-Active	Ⓢ 8745-1325	Ⓢ 8245-1326				
		STR.T	Ⓢ 8750-1123	Ⓢ 8250-1044				
		Sport	ⓈⓈ 8741-1572Sport	Ⓢ 8240-1296Sport				
Front axle load up to 930 kg		STR.T Kit			1120-8435-1	35	35	1,2,13
		Sport Kit			1140-8435-1	35	35	1,2,13,17
Front axle load as from 931 kg, up to 1010 kg		STR.T Kit			1120-8433-1	35	35	1,2,13
		Sport Kit			1140-8433-1	35	35	1,2,13,17
Front axle load as from 1011 kg		STR.T Kit			1120-8434-1	35	35	1,2,13
		Sport Kit			1140-8434-1	35	35	1,2,13,17
Front: for original struts 55 mm only Rear: only for cars with multi-link suspension.		Special-Active	Ⓢ 8745-1325	Ⓢ 8245-1327				
		STR.T	Ⓢ 8750-1123	Ⓢ 8250-1050				
		Sport	ⓈⓈ 8741-1572Sport	Ⓢ 8240-1297Sport				
Front axle load up to 930 kg		STR.T Kit			1120-8436-1	35	35	1,2,13
		Sport Kit			1140-8436-1	35	35	1,2,13,17
Front axle load up to 930 kg		STR.T Kit			1120-8431-1	35	35	1,2,13
		Sport Kit			1140-8431-1	35	35	1,2,13,17
Front axle load as from 1011 kg		STR.T Kit			1120-8432-1	35	35	1,2,13
		Sport Kit			1140-8432-1	35	35	1,2,13,17
<b>Golf 7 GTI/Clubsport/GTD, excl. DCC</b> Front: for original struts 55 mm only Rear: only for cars with multi-link suspension.	11.12-06.19	Special-Active	Ⓢ 8745-1325	Ⓢ 8245-1327				
		Sport	ⓈⓈ 8741-1572Sport	Ⓢ 8240-1297Sport				
Front axle load up to 1010 kg		Sport Kit			1140-8401	35	35	1,2,13,17
Front axle load as from 1011 kg		Sport Kit			1140-8402	35	35	1,2,13,17
<b>Golf 7 2.0 TSi R 4-Motion</b> excl. DCC (Dynamic Chassis Control)	01.13-06.19	Special-Active	Ⓢ 8745-1325	Ⓢ 8245-1327				
		Sport	ⓈⓈ 8741-1572Sport	Ⓢ 8240-1297Sport				
		Sport Kit			1140-8161	25	25	1,2,13,17
<b>Golf 7 1.4 TSi GTE Plug-in Hybrid</b> excl. DCC (Dynamic Chassis Control)	14-06.19	Special-Active	Ⓢ 8745-1388	Ⓢ 8245-1327				
		Sport	ⓈⓈ 8741-1572Sport	Ⓢ 8240-1297Sport				
		Sport Kit			1140-4310	35	35	1,2,13,17
<b>Golf 7 GTI / GTD / Clubsport / R incl 4-Motion</b> Front: for original struts 55 mm only Rear: only for cars with multi-link suspension front axle load up to 1090 kg , rear axle load up to 1000 kg. Excl. DCC	11.12-06.19	Trackday Kit			1250-1001	60	50	1,16,21,23
<b>Golf 7 Variant, excl. DCC, GTD, R, Alltrack</b> Front: for original struts 50 mm only Rear: only for cars with torsion-beam rear suspension	05.13-06.19	Special-Active	Ⓢ 8745-1324	Ⓢ 8245-1326				
		STR.T	Ⓢ 8750-1115	Ⓢ 8250-1044				
		Sport	ⓈⓈ 8741-1571Sport	Ⓢ 8240-1296Sport				
Front axle load up to 1010 kg		STR.T Kit			1120-8403	35	35	1,2,13
		Sport Kit			1140-8403	30	45	1, 2, 13, 17
Front axle load as from 1011 kg		STR.T Kit			1120-8404	35	45	1,2,13
		Sport Kit			1140-8404	30	45	1, 2, 13, 17
Front: for original struts 50 mm only Rear: only for cars with multi-link suspension		Special-Active	Ⓢ 8745-1324	Ⓢ 8245-1327				
		STR.T	Ⓢ 8750-1115	Ⓢ 8250-1050				
		Sport	ⓈⓈ 8741-1571Sport	Ⓢ 8240-1297Sport				
Front axle load up to 1010 kg		STR.T Kit			1120-8405	35	45	1,2,13
		Sport Kit			1140-8405	30	45	1,2,13,17
Front axle load as from 1011 kg		STR.T Kit			1120-8406	35	45	1,2,13
		Sport Kit			1140-8406	30	45	1,2,13,17
Front: for original struts 55 mm only Rear: only for cars with torsion-beam rear suspension		Special-Active	Ⓢ 8745-1325	Ⓢ 8245-1326				
		STR.T	Ⓢ 8750-1123	Ⓢ 8250-1044				
		Sport	ⓈⓈ 8741-1572Sport	Ⓢ 8240-1296Sport				
Front axle load up to 1010 kg		STR.T Kit			1120-8403-1	35	45	1,2,13
		Sport Kit			1140-8403-1	30	45	1,2,13,17
Front axle load as from 1011 kg		STR.T Kit			1120-8404-1	30	45	1,2,13
		Sport Kit			1140-8404-1	30	45	1,2,13,17
<b>Golf 7 Variant, incl. GTD, excl. DCC, R, Alltrack</b> Front: for original struts 55 mm only Rear: only for cars with multi-link suspension.	05.13-06.19	Special-Active	Ⓢ 8745-1325	Ⓢ 8245-1327				
		STR.T	Ⓢ 8750-1123	Ⓢ 8250-1050				
		Sport	ⓈⓈ 8741-1572Sport	Ⓢ 8240-1297Sport				
Front axle load up to 1010 kg		STR.T Kit			1120-8405-1	30	45	1,2,13
		Sport Kit			1140-8405-1	30	45	1,2,13,17
Front axle load as from 1011 kg		STR.T Kit			1120-8406-1	35	45	1,2,13
		Sport Kit			1140-8406-1	30	45	1, 2, 13, 17

MAKE	Model	Year	product range				Lowering up to ..mm		Notes
							Front	Rear	
<b>VOLKSWAGEN - CONTINUED</b>									
	<b>Golf 7 Variant 2.0 TSi R 4-Motion</b> excl. DCC (Dynamic Chassis Control)	15-06.19	Sport	ⓂⓄ 8741-1572Sport	Ⓞ 8240-1297Sport				
			Sport Kit			1140-8162	25	25	1, 2, 13, 17
	<b>Golf 7 Variant GTD, R &amp; 4-Motion</b> Front: for original struts 55 mm only Rear: only for cars with multi-link suspension front axle load up to 1090 kg , rear axle load up to 1000 kg. Excl. DDC	05.13-06.19	Trackday Kit			1250-1001	60	50	1,16,,21,23
	<b>Golf 7 Sportsvan, excl. DCC</b> Front: for original struts 50 mm only Rear: only for cars with torsion-beam rear suspension	01.13-06.19	Special-Active	Ⓞ 8745-1324	Ⓞ 8245-1326				
			STR.T	Ⓞ 8750-1115	Ⓞ 8250-1044				
			Sport	ⓂⓄ 8741-1571Sport	Ⓞ 8240-1296Sport				
			Special-Active	Ⓞ 8745-1324	Ⓞ 8245-1327				
			STR.T	Ⓞ 8750-1115	Ⓞ 8250-1050				
	Front: for original struts 50 mm only Rear: only for cars with multi-link suspension		Sport	ⓂⓄ 8741-1571Sport	Ⓞ 8240-1297Sport				
<b>Jetta 1</b>									
	<b>Jetta 1, excl. Diesel</b>	79-01.84	Classic	Ⓞ 86-1919					
			STR.T	Ⓞ 8650-1005	Ⓞ 8050-1010				
			Sport	86-1919Sport	80-2307Sport				
			Sport	ⓂⓄ 8641-1048Sport	T3ⓄⓂⓄ 8041-1101Sport				
	<b>Jetta 1 Diesel</b>	80-01.84	STR.T	Ⓞ 8650-1005	Ⓞ 8050-1010				
			Sport	86-1919Sport	80-2307Sport				
<b>Jetta 2</b>									
	<b>Jetta 2 C, CL, GL</b>	02.84-92	STR.T	Ⓞ 8750-1008	Ⓞ 8050-1007				
			Sport	ⓂⓄ 8741-1258Sport	M3ⓄⓂ 80-2542Sport				
			STR.T Kit			1120-5412	35	35	1,2,13
			Sport Kit			1140-5412	35	35	1,2,13,17
			Coil-over Kit			1150-5001-1	65	55	1,2,13,16,21,22
	<b>Jetta 2 Diesel and Turbo-Diesel</b>	02.84-92	STR.T	Ⓞ 8750-1008	Ⓞ 8050-1007				
			Sport	ⓂⓄ 8741-1258Sport	M3ⓄⓂ 80-2542Sport				
			Coil-over Kit			1150-5001-1	65	55	1,2,13,16,21,22
	<b>Jetta 2 GT, excl. 16V</b>	02.84-92	STR.T	Ⓞ 8750-1008	Ⓞ 8050-1007				
			Sport	ⓂⓄ 8741-1258Sport	M3ⓄⓂ 80-2542Sport				
			STR.T Kit			1120-5412	35	35	1,2,13
			Sport Kit			1140-5412	35	35	1,2,13,17
		Coil-over Kit			1150-5001-1	65	55	1,2,13,16,21,22	
	<b>Jetta 2 GT 16V</b>	86-92	STR.T	Ⓞ 8750-1008	Ⓞ 8050-1008				
			Sport	ⓂⓄ 8741-1258Sport	M3ⓄⓂ 80-2587Sport				
			Sport Kit			1140-6322	30	30	1, 2, 13, ,17
			Coil-over Kit			1150-5001-1	65	55	1,2,13,16,21,22
	<b>Jetta 2 Syncro 4WD</b>	86-91	STR.T	Ⓞ 8750-1008					
			Sport	ⓂⓄ 8741-1258Sport					
<b>Jetta (US markets only)</b>									
	<b>Jetta 3, excl. VR6</b>	93-98	STR.T	Ⓞ 8750-1008	Ⓞ 8050-1007				
			Sport	ⓂⓄ 8741-1258Sport	M3ⓄⓂ 80-2542Sport				
	<b>Jetta 3 VR6</b>	93-98	STR.T	Ⓞ 8750-1009					
			Sport	ⓂⓄ 8741-1259Sport	T1ⓄⓂⓄ 8041-1108Sport				
	<b>Jetta 4, excl. Variant</b>	99-03	Special-Active	Ⓞ 8745-1029	Ⓞ 8045-1083				
			STR.T	Ⓞ 8750-1002	Ⓞ 8050-1001				
			Sport	ⓂⓄ 8710-1337Sport	80-2761Sport				
	<b>Jetta 5 2.5 - 5 cyl. 112kW</b> Front: for original struts 55 mm only	05-10	Special-Active	Ⓞ 8745-1038	Ⓞ 8045-1085				
			STR.T	Ⓞ 8750-1005	Ⓞ 8050-1006				
			Sport	ⓂⓄ 8710-1431Sport	Ⓞ 80-2859Sport				
			STR.T Kit			1120-2612	35	35	1,2,13
			Sport Kit			1140-2612	35	35	1,2,13,17
		Coil-over Kit			1150-5080-1	60	50	17,21,23 NO T V	
	<b>Jetta 6</b>	10-16	Sport			I.D.			
<b>Jetta 5</b>									
	<b>Jetta 5</b> Front: for original struts 55 mm only	05-10	Special-Active	Ⓞ 8745-1038	Ⓞ 8045-1084				
			STR.T	Ⓞ 8750-1005	Ⓞ 8050-1006				
			Sport	ⓂⓄ 8710-1431Sport	80-2859Sport				
	Front axle load up to 1020 kg		STR.T Kit			1120-2611	35	35	1,2,13
			Sport Kit			1140-2611	35	35	1,2,13,17
			Coil-over Kit			1150-5080-1	60	50	17,21,23 NO T V
	Front axle load as from 1021 kg		STR.T Kit			1120-2612	35	35	1,2,13
			Sport Kit			1140-2612	35	35	1,2,13,17
			Coil-over Kit			1150-5080-1	60	50	17,21,23 NO T V
	Front: for original struts 50 mm only		STR.T	Ⓞ 8750-1006	Ⓞ 8050-1006				
			Sport	ⓂⓄ 8710-1432Sport	80-2859Sport				
	Front axle load up to 1020 kg		STR.T Kit			1120-2613	35	35	1,2,13
			Sport Kit			1140-2613	35	35	1,2,13,17
	Front axle load as from 1021 kg		STR.T Kit			1120-2614	35	35	1,2,13
		Sport Kit			1140-2614	35	35	1,2,13,17	
<b>Jetta 6</b>									
	<b>Jetta 6</b> Front: for original struts 55 mm only	10-17	Special-Active	Ⓞ 8745-1038	Ⓞ 8045-1085				
			STR.T	Ⓞ 8750-1005	Ⓞ 8050-1006				
			Sport	ⓂⓄ 8710-1431Sport	80-2859Sport				
	Front axle load up to 980 kg		STR.T Kit			1120-0080	35	35	1,2,13
			Sport Kit			1140-0080	35	35	1,2,13,17
			Coil-over Kit			1150-5080-1	60	50	17,21,23 NO T V

MAKE	Model	Year	product range				Lowering up to ..mm		Notes
							Front	Rear	
<b>VOLKSWAGEN - CONTINUED</b>									
	Front axle load as from 981 kg, up to 1020 kg		STR.T Kit			1120-0081	35	35	1,2,13
			Sport Kit			1140-0081	35	35	1,2,13,17
			Coil-over Kit			1150-5080-1	60	50	17,21,23 NO T V
	Front axle load as from 1021 kg		STR.T Kit			1120-0082	35	35	1,2,13
			Sport Kit			1140-0082	35	35	1,2,13,17
			Coil-over Kit			1150-5080-1	60	50	17,21,23 NO T V
	Front: for original struts 50 mm only		Special-Active		© 8045-1085				
			STR.T	© 8750-1006	© 8050-1006				
			Sport	☞ 8710-1432Sport	80-2859Sport				
	Front axle load up to 980 kg		STR.T Kit			1120-0085	35	35	1,2,13
			Sport Kit			1140-0085	35	35	1,2,13,17
	Front axle load as from 981 kg, up to 1020 kg		STR.T Kit			1120-0086	35	35	1,2,13
			Sport Kit			1140-0086	35	35	1,2,13,17
	Front axle load as from 1021 kg		STR.T Kit			1120-0087	35	35	1,2,13
			Sport Kit			1140-0087	35	35	1,2,13,17
	<b>Jetta 6 Hybrid</b> Front: for original struts 55 mm only Rear: only for cars with multi-link suspension.	01.13-18	Special-Active	© 8745-1038	© 8045-1226				
			Sport	☞ 8710-1431Sport	80-2859Sport				
<b>Lavida</b>									
	<b>Lavida</b>	08-12	Special-Active	© 8745-1029	© 8045-1083				
			STR.T	© 8750-1002	© 8050-1001				
			Sport	☞ 8710-1337Sport	80-2761Sport				
<b>Lupo</b>									
	<b>Lupo</b> Excl. GTI	98-05	STR.T	© 8750-1001	© 8050-1002				
	1.0, 1.4, 1.4 16V		STR.T Kit			1120-5291	30	30	1,2,13
	1.4 TDI, 1.7 SDI, excl. 1.2 TDI 3L		STR.T Kit			1120-5292	30	30	1,2,13
<b>Magotan</b>									
	<b>Magotan Sedan</b>	07-13	Special-Active	© 8745-1081	© 8045-1085				
			Sport	☞ 8741-1488Sport	© 8040-1352Sport				
	<b>Magotan Variant</b>	10-13	Special-Active	© 8745-1081	© 8045-1085				
			Sport	☞ 8741-1488Sport	© 8040-1352Sport				
	<b>Magotan CC</b>	10-13	Special-Active	© 8745-1081	© 8045-1085				
			Sport	☞ 8741-1488Sport	© 8040-1352Sport				
<b>New Beetle</b>									
	<b>New Beetle</b> excl. 4-Motion	98-11.11	STR.T	© 8750-1002	© 8050-1004				
	1.4, 1.6, 1.8T, 2.0, 2.3		STR.T Kit			1120-4891	40	40	1,2,13
	1.9 TDI		STR.T Kit			1120-4892	40	40	1,2,13
	<b>New Beetle Cabrio</b> excl. 4-Motion	03.02-11.11	STR.T	© 8750-1002	© 8050-1004				
	1.4, 1.6, 1.8T, 2.0, 2.3		STR.T Kit			1120-4893	40	40	1,2,13
	1.9 TDI		STR.T Kit			1120-4894	40	40	1,2,13
	<b>Beetle 1.2 TSI, 1.4 TSI, 2.5, 1.6 TDI, 2.0 TDI</b> Front: for original struts 55 mm only	10.11-18	Special-Active	© 8745-1006					
	Front: for original struts 50 mm only		Sport	☞ 8710-1431Sport					
			Sport	☞ 8710-1432Sport					
	If equipped with multi-link suspension rear (option code 0N4)		Special-Active	© 8745-1225	© 8045-1226				
			Sport	☞ 8710-1431Sport	80-2859Sport				
			Sport Kit			1140-8973	30	40	1,2,13,17
	<b>Beetle 2.0 TSI</b>	10.11-18	Special-Active	© 8745-1225	© 8045-1226				
			Sport	☞ 8710-1431Sport	80-2859Sport				
			Sport Kit			1140-8973	30	40	1,2,13,17
<b>Passat</b>									
	<b>Passat 32B, incl. Syncro</b>	81-03.88	Sport		86-2066Sport				
	<b>Passat 35i Sedan/Variant, excl. VR6</b> Front: as from 1991, only for non-sealed struts without dent in housing to clear the tire	04.88-09.96	Sport		☞ 8641-1198Sport				
	<b>Passat 35i Sedan/Variant VR6</b> p to chassisno. 31M320488 only for non-sealed OE struts without dent in housing to clear the tire	91-93	Sport		☞ 8641-1198Sport				
	<b>Passat 35i Syncro G60</b> AWD	89-09.91	Sport		☞ 8641-1198Sport				
	<b>Passat 3B Sedan, excl. Syncro/4-Motion</b> if equipped with VW Sport Suspension: KONI Special is excluded	10.96-11.00	STR.T	© 8250-1001	© 8050-1009				
			Sport		82-2488Sport	© 8040-1227Sport			
	Front axle load up to 970 kg		STR.T Kit			1120-7731	35	35	1,2,13
			Sport Kit			1140-7731	35	35	1,2,13
	Front axle load as from 971 kg, excl 2.5 TDI		STR.T Kit			1120-7732	35	35	1,2,13
			Sport Kit			1140-7732	35	35	1,2,13
	2.5 TDI		STR.T Kit			1120-7733	35	35	1,2,13
			Sport Kit			1140-7733	35	35	1,2,13
	<b>Passat 3B Variant, excl. Syncro/4-Motion</b> excl. self-levelling systems - if equipped with VW Sport Suspension: KONI Special is excluded	06.97-11.00	STR.T	© 8250-1001	© 8050-1009				
			Sport		82-2488Sport	© 8040-1227Sport			
	Front axle load up to 970 kg		STR.T Kit			1120-7941	40	40	1,2,13
			Sport Kit			1140-7941	40	40	1,2,13
	Front axle load as from 971 kg, excl 2.5 TDI		STR.T Kit			1120-7942	40	40	1,2,13
			Sport Kit			1140-7942	40	40	1,2,13
	2.5 TDI		STR.T Kit			1120-7943	40	40	1,2,13
			Sport Kit			1140-7943	40	40	1,2,13



MAKE		product range				Lowering up to ..mm		Notes
Model	Year					Front	Rear	
<b>VOLKSWAGEN - CONTINUED</b>								
Passat 3B Sedan/Variant Syncro/4-Motion excl. self-levelling systems	06.97-00	STR.T	Ⓒ 8250-1001	ⒺⒸ 8250-1004				
		Sport	82-2488Sport	Ⓔ 82-2465Sport				
		STR.T Kit			1120-7951	35	35	1,2,13
		Sport Kit			1140-7951	35	35	1,2,13
Passat 3BG Sedan, excl. 4-Motion if equipped with VW Sport Suspension: KONI Special is excluded	11.00-05	STR.T	Ⓒ 8250-1001	Ⓒ 8050-1009				
		Sport	82-2488Sport	Ⓒ 8040-1227Sport				
		STR.T Kit			1120-7731	35	35	1,2,13
		Sport Kit			1140-7731	35	35	1,2,13
		STR.T Kit			1120-7732	35	35	1,2,13
		Sport Kit			1140-7732	35	35	1,2,13
Front axle load up to 970 kg		STR.T Kit			1120-7733	35	35	1,2,13
Front axle load as from 971 kg, excl 2.5 TDI		Sport Kit			1140-7733	35	35	1,2,13
2.5 TDI		STR.T Kit			1120-7733	35	35	1,2,13
		Sport Kit			1140-7733	35	35	1,2,13
Passat 3BG Variant, excl. 4-Motion excl. self-levelling systems - if equipped with VW Sport Suspension: KONI Special is excluded	11.00-05	STR.T	Ⓒ 8250-1001	Ⓒ 8050-1009				
		Sport	82-2488Sport	Ⓒ 8040-1227Sport				
		STR.T Kit			1120-7941	40	40	1,2,13
		Sport Kit			1140-7941	40	40	1,2,13
		STR.T Kit			1120-7942	40	40	1,2,13
		Sport Kit			1140-7942	40	40	1,2,13
Front axle load up to 970 kg		STR.T Kit			1120-7943	40	40	1,2,13
Front axle load as from 971 kg, excl 2.5 TDI		Sport Kit			1140-7943	40	40	1,2,13
2.5 TDI		STR.T Kit			1120-7943	40	40	1,2,13
		Sport Kit			1140-7943	40	40	1,2,13
Passat 3BG Sedan/Variant 4-Motion excl. self-levelling systems	00-05	STR.T	Ⓒ 8250-1001	ⒺⒸ 8250-1004				
		Sport	82-2488Sport	Ⓔ 82-2465Sport				
		STR.T Kit			1120-7951	35	35	1,2,13
		Sport Kit			1140-7951	35	35	1,2,13
Passat 3C Sedan Front: for original struts 55 mm only	03.05-14	Special-Active	Ⓒ 8745-1081	Ⓒ 8045-1085				
		Sport	Ⓒ 8741-1488Sport	Ⓒ 8040-1352Sport				
		Sport Kit			1140-1621	40	40	1,2,13,15,17
		Sport Kit			1140-1622	40	40	1,2,13,15,17
Passat 3C Variant Front: for original struts 55 mm only. Excl. self-levelling systems	08.05-14	Special-Active	Ⓒ 8745-1081	ⒺⒸ 8045-1085				
		Sport	Ⓒ 8741-1488Sport	ⒺⒸ 8040-1352Sport				15
		Sport Kit			1140-1623	40	40	1,2,13,15,17
		Sport Kit			1140-1624	40	40	1,2,13,15,17
Passat 3C Sedan, Variant 4Motion Front: for original struts 55 mm only. Excl. self-levelling systems	03.05-14	Special-Active	Ⓒ 8745-1081	ⒺⒸ 8045-1085				
		Sport	Ⓒ 8741-1488Sport	ⒺⒸ 8040-1352Sport				15
		Sport Kit			1140-1625	40	40	1,2,13,15,17
		Sport Kit			1140-1626	40	40	1,2,13,15,17
Passat 3C R36	04.07-14	Special-Active	Ⓒ 8745-1081	ⒺⒸ 8045-1085				
		Sport	Ⓒ 8741-1488Sport	ⒺⒸ 8040-1352Sport				
		Sport Kit			1140-1624	40	40	1,2,13,15,17
		Sport Kit			1140-1626	40	40	1,2,13,15,17
Passat CC	01.08-17	Special-Active	Ⓒ 8745-1081	ⒺⒸ 8045-1085				
		Sport	Ⓒ 8741-1488Sport	ⒺⒸ 8040-1352Sport				
		Sport Kit			1140-1627	40	40	1,2,13,15,17
		Sport Kit			1140-1628	40	40	1,2,13,15,17
Passat CC 4Motion	01.08-17	Special-Active	Ⓒ 8745-1081	ⒺⒸ 8045-1085				
		Sport	Ⓒ 8741-1488Sport	ⒺⒸ 8040-1352Sport				
		Sport Kit			1140-1623	40	40	1,2,13,15,17
		Sport Kit			1140-1624	40	40	1,2,13,15,17
Passat (B8) Sedan & Variant incl. 4Motion excl. GTE, DCC (Dynamic Chassis Control)	01.15-19	Special-Active	Ⓒ 8745-1388	Ⓒ 8245-1387				
		Sport	Ⓒ 8741-1572Sport	Ⓒ 8240-1311Sport				
		Sport Kit						I.D.
Passat (B8) GTE Plug-in Hybrid Sedan & Variant excl. DCC (Dynamic Chassis Control)	15-19	Special-Active	Ⓒ 8745-1388	Ⓒ 8245-1387				
		Sport	Ⓒ 8741-1572Sport	Ⓒ 8240-1311Sport				
<b>Polo</b>								
Polo 86(C), incl. Coupé & Sedan	75-94	Sport		86-1922Sport	80-2315Sport			
Polo G40	08.88-94	Sport		86-2483Sport	80-2315Sport			
Polo 3 (6N)	10.94-09.99	STR.T	Ⓒ 8750-1001	Ⓒ 8050-1003				
		STR.T Kit			1120-9811	30	30	1,2,13
Polo 3 (6N) GTI	10.94-09.99	STR.T	Ⓒ 8750-1001	Ⓒ 8050-1003				
		STR.T Kit			1120-4541	35	35	1,2,13
Polo 3 (6N2)	10.99-10.01	STR.T	Ⓒ 8750-1001	Ⓒ 8050-1003				
		STR.T Kit			1120-4202	35	35	1,2,13
		STR.T Kit			1120-4201	35	35	1,2,13
Polo 3 (6N2) GTI	10.99-10.01	STR.T	Ⓒ 8750-1001	Ⓒ 8050-1003				
		STR.T Kit			1120-4201	35	35	1,2,13
Polo 3 Classic Sedan (6KV)	01.96-02	STR.T	Ⓒ 8750-1001	Ⓒ 8050-1003				
Polo 3 Variant (6KV)	09.97-01	STR.T	Ⓒ 8750-1001	Ⓒ 8050-1003				
Polo 4 9N(3), excl. 'Fun', Cross Polo & GTI	11.01-06.09	Special-Active	Ⓒ 8745-1069	Ⓒ 8045-1070				
		STR.T	Ⓒ 8750-1004	Ⓒ 8050-1005				
		Sport	Ⓒ 8710-1404Sport	80-2830Sport				
		STR.T Kit			1120-3331	35	35	1,2,13
Front axle load up to 830 kg		Sport Kit			1140-3331	35	35	1,2,13

MAKE	Model	Year	product range				Lowering up to ..mm		Notes
							Front	Rear	
<b>VOLKSWAGEN - CONTINUED</b>									
	Front axle load as from 831 kg		STR.T Kit			1120-3332	35	35	1,2,13
			Sport Kit			1140-3332	35	35	1,2,13
	<b>Polo 4 9N(3) 1.9TDI (96kW), GTI (incl. Cup)</b> KONI Sport (Kit), front: to be adjusted one full turn	01-09	Sport	Ⓜ 8710-1404Sport		80-2830Sport			
			Sport Kit			1140-3333	30-35	30-35	1,2,13,17
	<b>Polo 5 / Polo 6 (6R/6C)</b> excl. DCC (Dynamic Chassis Control)	09-09-17	Special-Active	Ⓞ 8745-1278		Ⓞ 8045-1070			
			STR.T	Ⓞ 8750-1114		Ⓞ 8050-1005			
			Sport	ⓂⓄ 8741-1548Sport		80-2830Sport			
	<b>Polo 5 (6R/6C)</b> Front axle load up to 929 kg	09-09-17	STR.T Kit			1120-9771	25	40	1,2,13
			Sport Kit			1140-9771	25	40	1,2,13,17
	Front axle load as from 930 kg		STR.T Kit			1120-9772	25	40	1,2,13
			Sport Kit			1140-9772	25	40	1,2,13,17
	<b>Polo 5 (6R/6C) 1.4 GTI, 1.8 GTI</b> excl. DCC (Dynamic Chassis Control)	09-09-17	Special-Active	Ⓞ 8745-1278		Ⓞ 8045-1070			
			Sport	ⓂⓄ 8741-1548Sport		80-2830Sport			
	Front axle load up to 929 kg		Sport Kit			1140-9771	20	30	1,2,13,17
	Front axle load as from 930 kg		Sport Kit			1140-9772	20	30	1,2,13,17
	<b>Polo 5 (6R/6C) Sedan</b> excl. DCC (Dynamic Chassis Control)	10-09-17	Special-Active	Ⓞ 8745-1278		Ⓞ 8050-1017			
			STR.T	Ⓞ 8750-1114		Ⓞ 8050-1017			
			Sport	ⓂⓄ 8741-1548Sport		80-2815Sport			
	<b>Polo 6 (2G, AW1, BZ1)</b>	06.17-	Sport	I.D.		I.D.			
			Sport Kit						I.D.
<b>Sagitar</b>									
	<b>Sagitar</b> Front: for original struts 50 mm only	06-10	STR.T	Ⓞ 8750-1006		Ⓞ 8050-1006			
			Sport	Ⓜ 8710-1432Sport		80-2859Sport			
<b>Santana</b>									
	<b>Santana 32B</b>	81-12.85	Sport			86-2066Sport			
<b>Scirocco</b>									
	<b>Scirocco 1 &amp; 2, incl. GTX-16V (53 / 53B)</b>	74-92	Classic	Ⓞ 86-1919					
			STR.T	Ⓞ 8650-1005		Ⓞ 8050-1010			
			Sport	86-1919Sport		80-2307Sport			
			Sport	ⓂⓄ 8641-1048Sport	T3ⓄⓂⓄⓄ	Ⓞ 8041-1101Sport			
	<b>Scirocco 3, 1.4TSi, 2.0TSi, 2.0TDi</b> excl. DCC (Dynamic Chassis Control)	03.08-11.17	Special-Active	Ⓞ 8745-1225	Ⓞ 8045-1226				
			STR.T	Ⓞ 8750-1005	Ⓞ 8050-1006				
			Sport	Ⓜ 8710-1431Sport	Ⓞ 80-2859Sport				
	Front: for original struts 55 mm only, front axle load up to 1020 kg		STR.T Kit			1120-0131	30-35	30-35	1,2,13
			Sport Kit			1140-0131	30-35	30-35	1,2,13,17
			Coil-over Kit			1150-5080-1	40	40	17,21,23 - NO T V
	Front: for original struts 55 mm only, front axle load as from 1021 kg		STR.T Kit			1120-0132	30-35	30-35	1,2,13
			Sport Kit			1140-0132	30-35	30-35	1,2,13,17
			Coil-over Kit			1150-5080-1	40	40	17,21,23 - NO T V
<b>Sharan</b>									
	<b>Sharan (7N) 1.4 TSi, 2.0 TSi, 2.0 TDi</b> incl. 4Motion, excl. DCC Suspension	10-19	Special-Active	Ⓞ 8745-1081		Ⓞ 8045-1085			
			Sport	ⓂⓄ 8741-1488Sport		Ⓞ 8040-1352Sport			
			Sport Kit			1140-9331	25	40	1,2,13,15,17
<b>Taro</b>									
	<b>Taro Pickup, with leaf springs front</b> AWD	89-96	eavy Track			Ⓞ 30-1407			
	<b>Taro Extra Cab, with torsion bars front</b> AWD	89-96	eavy Track			Ⓞ 30-1407			
<b>Tiguan</b>									
	<b>Tiguan (5N) 1.4TSi, 2.0TSi, 2.0TDi incl. 4-Motion</b> excl. DCC (Dynamic Chassis Control)	07-16	Special-Active	Ⓞ 8745-1263		Ⓞ 8045-1228			
			Sport	ⓂⓄ 8741-1488Sport		Ⓞ 8040-1395Sport			
	<b>Tiguan (AD1) 1.4TSi, 2.0TSi, 2.0TDi incl. 4-Motion</b> excl. DCC (Dynamic Chassis Control)	16-19	Special-Active	Ⓞ 8745-1388		Ⓞ 8245-1387			
			Sport	ⓂⓄ 8741-1572Sport		Ⓞ 8240-1311Sport			
<b>Touran</b>									
	<b>Touran, excl. Cross Touran</b> Front: for original struts 55 mm only	03-08.10	Special-Active	Ⓞ 8745-1038	Ⓞ 8045-1085				
			Sport	ⓂⓄ 8741-1488Sport	Ⓞ 8040-1352Sport				
	Front axle load up to 1130 kg		Sport Kit			1140-2743	35	35	1,2,13,15,17
	Front axle load as from 1131 kg		Sport Kit			1140-2744	35	35	1,2,13,15,17
	<b>Touran, excl. Cross Touran</b> Front: for original struts 55 mm only	09.10-05.15	Special-Active	Ⓞ 8745-1038	Ⓞ 8045-1085				
			Sport	ⓂⓄ 8741-1488Sport	Ⓞ 8040-1352Sport				
			Sport Kit			1140-1622	40	40	1,2,13,15,17
<b>T-Roc</b>									
	<b>T-Roc (A11) 1.0TSi, 1.5TSi, 2.0TSi, 2.0TDi</b>	07.17-	Special-Active	I.D.		I.D.			
<b>Up</b>									
	<b>Up</b>	11-19	Sport			ⓂⓄ 8041-1418Sport			
<b>Vento</b>									
	<b>Vento 1.4, 1.6, 1.8, excl. GT, GTi</b> cars with 4-bolt wheels	91-10.97	STR.T	Ⓞ 8750-1008		Ⓞ 8050-1007			
			Sport	ⓂⓄ 8741-1258Sport		M3ⓄⓂ 80-2542Sport			
			Coil-over Kit			1150-5002-1	65	50	16,21,22
	<b>Vento 1.8GT, 1.9TDi, 2.0 Autom. GT, GTi, GTi-16V</b> cars with 5-bolt wheels (Plus-suspension)	92-10.97	STR.T	Ⓞ 8750-1009		Ⓞ 8050-1008			
			Sport	ⓂⓄ 8741-1259Sport					
			Coil-over Kit			1150-5002-1	65	50	16,21,22
	<b>Vento VR6</b> cars with 5-bolt wheels (Plus-suspension)	09.94-10.97	STR.T	Ⓞ 8750-1009		Ⓞ 8050-1008			
			Sport	ⓂⓄ 8741-1259Sport		M3ⓄⓂ 80-2587Sport			

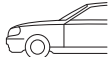

MAKE		Year	product range				Lowering up to ..mm		Notes
Model							Front	Rear	
<b>VOLKSWAGEN - CONTINUED</b>									
Excl. Syncro			STR.T Kit			1120-8722	30	30	1,2,13
			Sport Kit			1140-8722	30	30	1,2,13,17
			Coil-over Kit			1150-5002-1	65	50	1,2,13,16,21,22
Vento Syncro cars with 5-bolt wheels (Plus-suspension)	09.94-10.97		STR.T	Ⓢ 8750-1009					
			Sport	ⓈⓈ 8741-1259Sport					
Vento (Polo Sedan) India version	10-18		Special-Active	Ⓢ 8745-1278					
			STR.T	Ⓢ 8750-1114	Ⓢ 8050-1017				Front: I.D.
			Sport	ⓈⓈ 8741-1548Sport	80-2815Sport				
<b>Commercials</b>									
Transporter T1	55-67	Classic	Ⓢ 80-1349	Ⓢ 80-1350					
Transporter T2a (Van, Bus) For availability contact www.efkaimport.nl	68-69	Classic	80-1966	80-1967					
Transporter T2a (Van, Bus) up to chassisno. 22.000.096	70-71	Classic	Ⓢ 80-2110	80-1967					
Transporter T2b (Van, Bus) as from chassisno. 22.000.097	72-79	Classic	Ⓢ 80-2110	80-2220					
Transporter T3 all, excl. Syncro	80-90	Classic	Ⓢ 82-2100	Ⓢ 82-2101					
Transporter T4 (Van, Bus, Multivan) incl. Syncro excl. lowered suspension and D suspension	90-03	Special	82-2379	82-2380					
Transporter T5 incl. 4Motion Front: only for clamped struts (no bracket)	03-15	Special	87-2645	82-2542					
		Special-Active	8705-1392	8205-1009					
Transporter T6 incl. 4Motion Front: only for clamped struts (no bracket) excl. DCC	15-19	Special	87-2645	82-2542					
		Special-Active	8705-1392	8205-1009					
Caddy 1	83-92	Classic	Ⓢ 86-1919						
		STR.T	Ⓢ 8650-1005						
		Sport	86-1919Sport						
		Sport	ⓈⓈ 8641-1048Sport						
Caddy 2, Van	96-04	STR.T	Ⓢ 8750-1001						
Caddy 3, 4 Front: for original struts 55 mm only	04-19	STR.T	Ⓢ 8750-1005						
		Special	ⓈⓈ 8710-1431Sport	□ 80-2879					
		Special-Active	Ⓢ 8745-1038						
Front: for original struts 50 mm only		STR.T	Ⓢ 8750-1006						
		Special	ⓈⓈ 8710-1432Sport	□ 80-2879					
Crafter 3.5T	06-10.16	Special	87-2656	82-2585					
		Special-Active	8705-1330	8805-1055					
Crafter 5.0T	06-10.16	Special	87-2657	82-2588					
		Special-Active	8705-1331	8805-1056					
<b>LT-series</b>									
LT 28 (2D), LT35 (2D) axle load 1350-1600 kg	05.96-03	Special	87-2604	82-2434					
LT 35 (2D) axle load 1750 kg	05.96-03	Special	87-2638	82-2434					
LT 46 axle load 1350-1600 kg Twin wheel rear	05.96-03	Special	87-2604	82-2440					
LT 46 axle load 1750 kg Twin wheel rear	05.96-03	Special	87-2638	82-2440					
<b>VOLVO</b>									
<b>C30</b>									
C30 excl. self-levelling systems	07-14	Special-Active	Ⓢ 8745-1110L Ⓢ 8745-1110R	ⓈⓈ 8045-1068					
		STR.T	Ⓢ 8750-1088L Ⓢ 8750-1088R	ⓈⓈ 8050-1108					
		Sport	ⓈⓈ 8741-1490LSport ⓈⓈ 8741-1490RSport	ⓈⓈ 8040-1351Sport					
Front axle load up to 1000 kg		STR.T Kit			1120-0861	30	30	1,2,13,15	
		Sport Kit			1140-0861	30	30	1,2,13,15,17	
Front axle load as from 1001 kg		STR.T Kit			1120-0862	30	30	1,2,13,15	
		Sport Kit			1140-0862	30	30	1,2,13,15,17	
<b>S40 / V40</b>									
S40 incl. Sport Suspension, excl. 4WD and self-levelling systems	04-12	Special-Active	Ⓢ 8745-1110L Ⓢ 8745-1110R	ⓈⓈ 8045-1096					15
		STR.T	Ⓢ 8750-1088L Ⓢ 8750-1088R	ⓈⓈ 8050-1109					
		Sport	ⓈⓈ 8741-1490LSport ⓈⓈ 8741-1490RSport	ⓈⓈ 8040-1353Sport					
		STR.T Kit			1120-2081	35	35	1,2,13,15	
		Sport Kit			1140-2081	35	35	1,2,13,15,17	
V40 Incl. sport suspension	01.12-18	Sport	ⓈⓈ 8741-1580LSport ⓈⓈ 8741-1580RSport	ⓈⓈ 8040-1425Sport					
<b>V50</b>									
V50 incl. Sport Suspension, excl. 4WD and self-levelling systems	04-12	Special-Active	Ⓢ 8745-1110L Ⓢ 8745-1110R	ⓈⓈ 8045-1096					15
		STR.T	Ⓢ 8750-1088L Ⓢ 8750-1088R	ⓈⓈ 8050-1109					
		Sport	ⓈⓈ 8741-1490LSport ⓈⓈ 8741-1490RSport	ⓈⓈ 8040-1353Sport					
		STR.T Kit			1120-2082	35	35	1,2,13,15	
		Sport Kit			1140-2082	35	35	1,2,13,15,17	

MAKE		Year	product range			Lowering up to ..mm		Notes
Model						Front	Rear	
<b>VOLVO - CONTINUED</b>								
<b>S60 / V60</b>								
S60 I, incl. T5, excl. 4WD & S60R Front: for original struts only	00-03-10	STR.T		N 8050-1099				
		Sport	8641-1410Sport	8040-1277Sport				
S60 II, incl. R-Design & AWD, excl. Four-C excl. self-levelling systems	10-18	Special-Active	8745-1241L 8745-1241R	8245-1256				
		Sport	8741-1538LSport 8741-1538RSport	8240-1268Sport				
		Front axle load up to 1140 kg	Sport Kit		1140-8898	30	30	1,2,13,15,17
		Front axle load as from 1141 kg	Sport Kit		1140-8899	30	30	1, 2, 13, 15, 17
		V60 II, incl. R-Design & AWD, excl. Four-C excl. self-levelling systems	10-18	Special-Active	8745-1241L 8745-1241R	8245-1256		
Sport	8741-1538LSport 8741-1538RSport	8240-1268Sport						
Front axle load up to 1140 kg	Sport Kit			1140-8893	30	30	1, 2, 13, 15, 17	
Front axle load as from 1141 kg	Sport Kit		1140-8894	30	30	1, 2, 13, 15, 17		
<b>S70 / V70</b>								
S70, excl. 4WD, T5-R excl. self-levelling systems	97-99	Special-Active	8745-1016	8245-1017				
		STR.T	8750-1060	8050-1080				
		Front axle load up to 1019 kg	STR.T Kit		1120-9581	30	30	1,2,13,15
Front axle load as from 1020 kg	STR.T Kit		1120-9582	30	30	1,2,13,15		
V70 I, excl. 4WD, Cross Country XC 4WD, T5-R excl. self-levelling systems	97-99	Special-Active	8745-1016	8245-1017				
		STR.T	8750-1060	8050-1080				
		Front axle load up to 1019 kg	STR.T Kit		1120-9551	35	35	1,2,13,15
Front axle load as from 1020 kg	STR.T Kit		1120-9553	35	35	1,2,13,15		
V70 II, excl. 4WD, Cross Country 4WD, V70-R excl. self-levelling systems - Front: for original struts only	00-06	STR.T		8050-1099				
		Sport	8641-1410Sport	8040-1277Sport				
		Sport Kit			1140-4521	30	30	1,2,13,15,17
V70 III 2WD, incl. R-Design, excl. Four-C excl. self-levelling systems	03-07-16	Special-Active	8745-1241L 8745-1241R	8245-1256				
		Sport	8741-1538LSport 8741-1538RSport	8240-1268Sport				
		Sport Kit			1140-0982	40	40	1,2,13,15,17
V70 III AWD, incl. R-Design, excl. Four-C excl. self-levelling systems	03-07-16	Special-Active	8745-1241L 8745-1241R	8245-1256				
		Sport	8741-1538LSport 8741-1538RSport	8240-1268Sport				
<b>C70</b>								
C70 I, Coupé & Convertible excl. self-levelling systems	97-05	Special-Active	8745-1016	8245-1017				
		STR.T	8750-1060	8050-1080				
C70 II, Coupé & Convertible	03-06-13	STR.T	8750-1088L 8750-1088R					
		Sport	8741-1490LSport 8741-1490RSport	8040-1405Sport				
		Sport Kit			1140-1151	35	35	1,2,13,15,17
<b>S80</b>								
S80 I, incl. T6, excl. S80-R, AWD and FourC Front: for original struts only, T6 front dampers: adjust one full turn	98-02-06	STR.T		8050-1099				
		Sport	8641-1410Sport	8040-1277Sport				
S80 II, incl. R-Design & AWD, excl. Four-C excl. self-levelling systems	03-06-16	Special-Active	8745-1241L 8745-1241R	8245-1256				
		Sport	8741-1538LSport 8741-1538RSport	8240-1268Sport				
<b>XC60</b>								
XC60, 2WD, 4WD excl. FOUR-C excl. self-levelling systems	05-08-17	Special-Active	8745-1313L 8745-1313R	8245-1308				
<b>XC70</b>								
XC70 II, 2WD, 4WD excl. FOUR-C excl. self-levelling systems	08-07-16	Special-Active	8745-1241L 8745-1241R	8245-1377				
<b>XC90</b>								
XC90 excl. Sport suspension, Four-C and self-levelling systems	02-09-14	Special-Active	8745-1383	8245-1383				
<b>240-, 260-series</b>								
240-, 260-series	78-93	Sport Kit	8641-1245Sport	26-1129Sport				
<b>740</b>								
740 Sedan / Wagon as from chassisno. F0081680	84-06-88	Sport		30-1479Sport				
740 Sedan / Wagon, excl. 2.0 Turbo-16V	07-88-92	Sport	8641-1246Sport	30-1479Sport				
<b>760</b>								
760 Sedan / 780 Coupé, incl. Turbo as from chassisno. F0081680	84-07-87	Sport		30-1479Sport				
760 Estate / Wagon, incl. Turbo as from chassisno. F0081680	85-06-88	Sport		30-1479Sport				
760 Sedan / 780 Coupé, incl. Turbo with IRS (independant rear suspension)	07-88-90	Sport	8641-1246Sport					
760 Estate / Wagon, incl. Turbo	07-88-90	Sport	8641-1246Sport	30-1479Sport				

MAKE		Year	product range				Lowering up to ..mm		Notes
Model	Front						Rear		
<b>VOLVO - CONTINUED</b>									
<b>850</b>									
850 Sedan, incl. T-5, T5-R excl. self-levelling systems	92-97	Special-Active	© 8745-1016	Ⓝ 8245-1017					
Front axle load up to 1019 kg		STR.T Kit	© 8750-1060	Ⓝ 8050-1080	1120-9581	30	30	1,2,13,15	
Front axle load as from 1020 kg		STR.T Kit			1120-9582	30	30	1,2,13,15	
850 Wagon, excl. T-5, T5-R excl. self-levelling systems	92-97	Special-Active	© 8745-1016	Ⓝ 8245-1017					
Front axle load up to 1019 kg		STR.T Kit	© 8750-1060	Ⓝ 8050-1080	1120-9551	35	35	1,2,13,15	
Front axle load as from 1020 kg		STR.T Kit			1120-9553	35	35	1,2,13,15	
<b>940</b>									
940 Sedan / Wagon, excl. 2.0i-16V Turbo and V6 excl. independent rear suspension	90-97	Sport	Ⓜ 8641-1246Sport	Ⓝ 30-1479Sport					
<b>960</b>									
960 Wagon (V90)	90-98	Sport	Ⓜ 8641-1246Sport	Ⓝ 30-1479Sport					
<b>Amazon</b>									
Amazon Sedan, excl. GT	57-69	Classic	☑ 80-1319	☑ 80-1320					
Amazon Wagon	62-69	Classic	☑ 80-1319						

pe	Ma e Model	A le	
<b>O26-SERIES</b>			
O26-1580	Land Rover (Range-Rover) Discovery Land Rover (Range-Rover) Range Rover	Front Front	P P P P
O26-1635	Nissan Patrol Nissan Patrol	Front Front	P P P P
<b>-SERIES</b>			
I.D.	Audi A3 Audi A4	Kit Front Rear	
	Audi Q2	Front Rear	
	Audi TT BMW 2	Kit Front Rear	
	Dacia Duster Ford Europe Fiesta	Front Rear	
	Ford Europe Focus Mercedes-Ben E-Class (W212) Mercedes-Ben V-Class (W638) (W447)	Front Kit Front Rear	
	Mercedes-Ben -Class (W470) Mini New Mini Porsche Boxster	Front Kit Front Rear	
	Porsche Cayman	Front Rear	
	Renault Alaskan	Front Rear	
	Seat Arona	Front Rear	
	Seat Ateca	Front Rear	
	Seat Ibi a	Front Rear	
	Skoda Karoq	Front Rear	
	Skoda Octavia Skoda Rapid Subaru Impre a	Kit Kit Front	
	Subaru WR	Front Rear	
	Toyota Fortuner Vauxhall (See also Opel) Astra Volkswagen Arteon	Rear Kit Front Rear	
	Volkswagen Jetta ( S markets only) Volkswagen Polo	Kit Front Rear	
	Volkswagen T-Roc	Front Rear	
<b>1120-SERIES</b>			
1120-0080	Volkswagen Golf 6	Kit	
1120-0081	Volkswagen Jetta 6	Kit	
1120-0082	Volkswagen Golf 6	Kit	
1120-0083	Volkswagen Jetta 6	Kit	
1120-0084	Volkswagen Golf 6	Kit	
1120-0085	Volkswagen Jetta 6	Kit	
1120-0086	Volkswagen Golf 6	Kit	
1120-0087	Volkswagen Jetta 6	Kit	
1120-0088	Volkswagen Golf 6	Kit	
1120-0089	Volkswagen Golf 6	Kit	
1120-0131	Volkswagen Scirocco	Kit	
1120-0132	Volkswagen Scirocco	Kit	
1120-0181	Seat Ibi a	Kit	
1120-0182	Seat Ibi a	Kit	
1120-0183	Seat Ibi a	Kit	
1120-0184	Seat Ibi a	Kit	
1120-0611	Audi A4 Audi A5	Kit Kit	
1120-0612	Audi A4 Audi A5	Kit Kit	
1120-0613	Audi A4 Audi A5	Kit Kit	
1120-0614	Audi A4 Audi A5	Kit Kit	
1120-0731	Skoda Fabia	Kit	
1120-0732	Skoda Fabia	Kit	
1120-0733	Skoda Fabia	Kit	
1120-0734	Skoda Fabia	Kit	
1120-0761	Mercedes-Ben C-Class (W204)	Kit	
1120-0762	Mercedes-Ben C-Class (W204)	Kit	
1120-0763	Mercedes-Ben C-Class (W204)	Kit	
1120-0764	Mercedes-Ben C-Class (W204)	Kit	
1120-0821	Skoda Roomster	Kit	
1120-0861	Volvo C30	Kit	

pe	Ma e Model	A le	
1120-0862	Volvo C30	Kit	
1120-1021	Audi TT	Kit	
1120-1022	Audi TT	Kit	
1120-1241	Skoda Octavia	Kit	
1120-1242	Skoda Octavia	Kit	
1120-1311	Alfa Romeo MiTo Fiat Grande Punto Opel Corsa	Kit Kit Kit	
1120-1312	Alfa Romeo MiTo Fiat Grande Punto Opel Corsa	Kit Kit Kit	
1120-1313	Fiat Grande Punto Opel Corsa	Kit Kit	
1120-1314	Fiat Grande Punto Opel Corsa	Kit Kit	
1120-1351	Ma da M -5	Kit	
1120-1401	Renault Clio	Kit	
1120-1402	Renault Clio	Kit	
1120-1404	Renault Clio	Kit	
1120-1405	Renault Clio	Kit	
1120-1406	Renault Clio	Kit	
1120-1407	Renault Clio	Kit	
1120-1541	Citroen C1 Peugeot 107 Peugeot 108 Toyota Aygo	Kit Kit Kit Kit	
1120-1601	Opel Agila Su uki Splash Su uki Swift Vauxhall (See also Opel) Agila	Kit Kit Kit Kit	
1120-1602	Su uki Splash Su uki Swift	Kit Kit	
1120-1611	Opel Astra	Kit	
1120-1612	Opel Astra	Kit	
1120-1761	Seat Leon Volkswagen Golf 5	Kit Kit	
1120-1762	Seat Leon	Kit	
1120-1791	Ma da 3 (Axela)	Kit	
1120-1821	Ford Europe Focus	Kit	
1120-1822	Ford Europe Focus	Kit	
1120-1827	Ford Europe Focus	Kit	
1120-1871	BMW 3-Series E90 91 92 93	Kit	
1120-1872	BMW 3-Series E90 91 92 93	Kit	
1120-1873	BMW 1-Series E81 E82 E87 E88	Kit	
1120-1875	BMW 3-Series E90 91 92 93	Kit	
1120-1876	BMW 3-Series E90 91 92 93	Kit	
1120-2001	Audi A6	Kit	
1120-2002	Audi A6	Kit	
1120-2003	Audi A6	Kit	
1120-2004	Audi A6	Kit	
1120-2081	Volvo S40 V40	Kit	
1120-2082	Volvo V50	Kit	
1120-2091	Opel Astra	Kit	
1120-2092	Opel Astra	Kit	
1120-2271	Audi A3	Kit	
1120-2281	Ma da 3 (Axela)	Kit	
1120-2282	Ma da 3 (Axela)	Kit	
1120-2283	Ma da 3 (Axela)	Kit	
1120-2284	Ma da 3 (Axela)	Kit	
1120-2285	Ma da 3 (Axela)	Kit	
1120-2291	Ford Europe Focus	Kit	
1120-2292	Ford Europe Focus	Kit	
1120-2401	Fiat Panda	Kit	
1120-2591	Mercedes-Ben CLK-Class (W209)	Kit	
1120-2592	Mercedes-Ben CLK-Class (W209)	Kit	
1120-2611	Audi A3 Seat Altea Seat Toledo Skoda Octavia Volkswagen Golf 5 Volkswagen Jetta 5	Kit Kit Kit Kit Kit Kit	
1120-2612	Audi A3 Seat Altea Seat Toledo Skoda Octavia Volkswagen Golf 5 Volkswagen Jetta ( S markets only) Volkswagen Jetta 5	Kit Kit Kit Kit Kit Kit Kit	
1120-2613	Audi A3 Seat Altea Seat Toledo Skoda Octavia Volkswagen Golf 5 Volkswagen Jetta 5	Kit Kit Kit Kit Kit Kit	
1120-2614	Audi A3 Seat Altea Seat Toledo Skoda Octavia Volkswagen Golf 5 Volkswagen Jetta 5	Kit Kit Kit Kit Kit Kit	
1120-2641	Ma da 2 (Demio)	Kit	
1120-2791	Seat Cordoba	Kit	
1120-2792	Seat Cordoba	Kit	
1120-3041	Peugeot 307	Kit	
1120-3042	Peugeot 307	Kit	
1120-3091	Citroen C2	Kit	

pe	Ma e Model	A le	
1120-3092	Citroen C3	Kit	
1120-3172	Citroen C3	Kit	
1120-3191-1	Ford Europe Fiesta	Kit	
1120-3192-1	Opel Vectra	Kit	
1120-3193-1	Opel Vectra	Kit	
	Opel Signum	Kit	
1120-3194-1	Opel Vectra	Kit	
	Opel Signum	Kit	
1120-3331	Opel Vectra	Kit	
	Seat Ibi a	Kit	
	Volkswagen Fox	Kit	
	Volkswagen Polo	Kit	
1120-3332	Seat Ibi a	Kit	
	Volkswagen Polo	Kit	
1120-3432	Mini New Mini	Kit	
1120-3471	Citroen C4	Kit	
	Peugeot 307	Kit	
1120-3472	Citroen C4	Kit	
	Peugeot 307	Kit	
1120-3601	Alfa Romeo GT	Kit	
	Alfa Romeo 147	Kit	
1120-3602	Alfa Romeo GT	Kit	
	Alfa Romeo 147	Kit	
1120-3651	Ford Europe Mondeo	Kit	
1120-3653	Ford Europe Mondeo	Kit	
1120-3681	Audi A4	Kit	
1120-3682	Audi A4	Kit	
1120-3691	Audi A4	Kit	
	Seat Exeo	Kit	
1120-3692	Audi A4	Kit	
	Seat Exeo	Kit	
1120-3761	Opel Corsa	Kit	
1120-3762	Opel Corsa	Kit	
	Opel Tigra	Kit	
1120-3771	Mercedes-Ben CLK-Class (W208)	Kit	
1120-3881	Audi A2	Kit	
1120-3882	Audi A2	Kit	
1120-3921	Mercedes-Ben C-Class (W203)	Kit	
	Mercedes-Ben CLC-Class (CL203)	Kit	
	Mercedes-Ben CLK-Class (W209)	Kit	
1120-3922	Mercedes-Ben C-Class (W203)	Kit	
1120-3923	Mercedes-Ben CLK-Class (W209)	Kit	
1120-4091	Skoda Fabia	Kit	
1120-4092	Skoda Fabia	Kit	
1120-4171	onda S2000	Kit	
1120-4191	BMW 3-Series E46	Kit	
1120-4192	BMW 3-Series E46	Kit	
1120-4201	Volkswagen Polo	Kit	
1120-4202	Volkswagen Polo	Kit	
1120-4251	Fiat Punto	Kit	
1120-4252	Fiat Punto	Kit	
1120-4351	Lexus IS	Kit	
1120-4352	Lexus IS	Kit	
1120-4353	Lexus IS	Kit	
1120-4354	Lexus IS	Kit	
1120-4381	Volkswagen Bora	Kit	
	Volkswagen Golf 4	Kit	
1120-4382	Audi A3	Kit	
	Seat Leon	Kit	
	Volkswagen Bora	Kit	
	Volkswagen Golf 4	Kit	
1120-4384	Audi S3	Kit	
1120-4391	Volkswagen Bora	Kit	
	Volkswagen Golf 4	Kit	
1120-4392	Volkswagen Bora	Kit	
	Volkswagen Golf 4	Kit	
1120-4421	Toyota aris Echo Vit	Kit	
1120-4541	Volkswagen Polo	Kit	
1120-4651	Ford Europe Focus	Kit	
1120-4691	Peugeot 206	Kit	
	Peugeot 206+	Kit	
1120-4692	Peugeot 206	Kit	
1120-4841	BMW 3-Series E46	Kit	
1120-4851	BMW 3-Series E46	Kit	
1120-4871	Ma da M -5	Kit	
1120-4891	Volkswagen New Beetle	Kit	
1120-4892	Volkswagen New Beetle	Kit	
1120-4893	Volkswagen New Beetle	Kit	
1120-4894	Volkswagen New Beetle	Kit	
1120-4961	Opel Astra	Kit	
1120-4962	Opel Astra	Kit	
1120-5051	Alfa Romeo 156	Kit	
1120-5052	Alfa Romeo 156	Kit	
1120-5151	Citroen sara	Kit	
1120-5212	Seat Cordoba	Kit	
1120-5261	Seat Leon	Kit	
	Seat Toledo	Kit	
	Volkswagen Bora	Kit	
	Volkswagen Golf 4	Kit	
1120-5262	Seat Leon	Kit	
	Seat Toledo	Kit	
	Volkswagen Bora	Kit	
	Volkswagen Golf 4	Kit	
1120-5281	Renault M gane	Kit	
1120-5282	Renault M gane	Kit	
1120-5291	Seat Arosa	Kit	

pe	Ma e Model	A le	
1120-5292	Volkswagen Lupo	Kit	
	Seat Arosa	Kit	
	Volkswagen Lupo	Kit	
1120-5301	Opel Astra	Kit	
1120-5302	Opel Astra	Kit	
1120-5403	Volkswagen Golf 1	Kit	
1120-5404	Volkswagen Golf 1	Kit	
1120-5412	Volkswagen Golf 2	Kit	
	Volkswagen Jetta 2	Kit	
	Volkswagen Golf 2	Kit	
1120-6322	Fiat Bravo Brava	Kit	
1120-6872	BMW 3-Series E36	Kit	
1120-7221	BMW 3-Series E36	Kit	
1120-7222	BMW 3-Series E36	Kit	
1120-7241	Mercedes-Ben E-Class (W210)	Kit	
1120-7242	Mercedes-Ben E-Class (W210)	Kit	
1120-7361	onda Civic	Kit	
1120-7421	BMW 5-Series E39	Kit	
1120-7423	BMW 5-Series E39	Kit	
1120-7491	Mercedes-Ben C-Class (W202)	Kit	
	Mercedes-Ben CLK-Class (W208)	Kit	
1120-7492	Mercedes-Ben C-Class (W202)	Kit	
	Mercedes-Ben CLK-Class (W208)	Kit	
1120-7493	Mercedes-Ben CLK-Class (W208)	Kit	
1120-7494	Mercedes-Ben CLK-Class (W208)	Kit	
1120-7571	Citroen Saxo	Kit	
	Peugeot 106	Kit	
1120-7641	BMW 5-Series E39	Kit	
1120-7671	Audi A3	Kit	
	Skoda Octavia	Kit	
1120-7672	Audi A3	Kit	
	Skoda Octavia	Kit	
1120-7673	Skoda Octavia	Kit	
1120-7674	Skoda Octavia	Kit	
1120-7731	Volkswagen Passat	Kit	
1120-7732	Volkswagen Passat	Kit	
1120-7733	Volkswagen Passat	Kit	
1120-7861	Citroen Saxo	Kit	
	Peugeot 106	Kit	
1120-7931	Audi A6	Kit	
1120-7932	Audi A6	Kit	
1120-7941	Volkswagen Passat	Kit	
1120-7942	Volkswagen Passat	Kit	
1120-7943	Volkswagen Passat	Kit	
1120-7951	Volkswagen Passat	Kit	
1120-7961	Audi A6	Kit	
1120-7962	Audi A6	Kit	
1120-7971	Audi A6	Kit	
1120-7972	Audi A6	Kit	
1120-7981	Audi A6	Kit	
1120-7982	Audi A6	Kit	
1120-8242	BMW 3-Series E36	Kit	
1120-8251	BMW 3-Series E36	Kit	
1120-8391	Ma da M -5	Kit	
1120-8403-1	Volkswagen Golf 7	Kit	
1120-8403	Volkswagen Golf 7	Kit	
1120-8404-1	Volkswagen Golf 7	Kit	
1120-8404	Volkswagen Golf 7	Kit	
1120-8405-1	Volkswagen Golf 7	Kit	
1120-8405	Volkswagen Golf 7	Kit	
1120-8406-1	Volkswagen Golf 7	Kit	
1120-8406	Volkswagen Golf 7	Kit	
1120-8431-1	Seat Leon	Kit	
	Volkswagen Golf 7	Kit	
1120-8431	Seat Leon	Kit	
	Volkswagen Golf 7	Kit	
1120-8432-1	Seat Leon	Kit	
	Volkswagen Golf 7	Kit	
1120-8432	Seat Leon	Kit	
	Volkswagen Golf 7	Kit	
1120-8433-1	Seat Leon	Kit	
	Volkswagen Golf 7	Kit	
1120-8433	Seat Leon	Kit	
	Volkswagen Golf 7	Kit	
1120-8434-1	Seat Leon	Kit	
	Volkswagen Golf 7	Kit	
1120-8434	Seat Leon	Kit	
	Volkswagen Golf 7	Kit	
1120-8435-1	Seat Leon	Kit	
	Volkswagen Golf 7	Kit	
1120-8435	Seat Leon	Kit	
	Volkswagen Golf 7	Kit	
1120-8436-1	Seat Leon	Kit	
	Volkswagen Golf 7	Kit	
1120-8436	Seat Leon	Kit	
	Volkswagen Golf 7	Kit	
1120-8584	Mercedes-Ben CLA-Class ( 117)	Kit	
1120-8631	onda Civic	Kit	
1120-8711	Peugeot 106	Kit	
1120-8722	Volkswagen Golf 3	Kit	
	Volkswagen Vento	Kit	
1120-8779-1	Ford Europe Mustang	Kit	
1120-8839-1	Renault Clio	Kit	
1120-8878-1	BMW 3-Series F30 F31 F34	Kit	
1120-8878-2	BMW 3-Series F30 F31 F34	Kit	
1120-8878-3	BMW 3-Series F30 F31 F34	Kit	
1120-8878-4	BMW 3-Series F30 F31 F34	Kit	

pe	Ma e Model	A le	
1120-8881-1	Mercedes-Ben A-Class (W176), B-Class (W246)	Kit	
1120-8881-2	Mercedes-Ben A-Class (W176), B-Class (W246)	Kit	
1120-8881-3	Mercedes-Ben CLA-Class (C117)	Kit	
1120-8881-4	Mercedes-Ben CLA-Class (C117)	Kit	
1120-8896-1	BMW 1-Series F20 F21	Kit	
	BMW 2-Series F22	Kit	
1120-8991	Kia Rio III	Kit	
1120-9011	Citroen A	Kit	
1120-9171	Audi A6	Kit	
	Audi A7	Kit	
1120-9172	Audi A6	Kit	
	Audi A7	Kit	
1120-9173	Audi A6	Kit	
	Audi A7	Kit	
1120-9174	Audi A6	Kit	
	Audi A7	Kit	
1120-9175	Audi A6	Kit	
1120-9176	Audi A6	Kit	
1120-9261	Mercedes-Ben C-Class (W202)	Kit	
1120-9271	Mercedes-Ben C-Class (W202)	Kit	
1120-9291	BMW 3-Series E36	Kit	
1120-9292	BMW 3-Series E36	Kit	
1120-9311	Seat Cordoba	Kit	
	Seat Ibi a	Kit	
1120-9312	Seat Cordoba	Kit	
	Seat Ibi a	Kit	
1120-9441	Audi A1	Kit	
1120-9442	Audi A1	Kit	
1120-9521	Fiat Punto	Kit	
	Lancia psilon	Kit	
1120-9551	Volvo S70 V70	Kit	
	Volvo 850	Kit	
1120-9553	Volvo S70 V70	Kit	
	Volvo 850	Kit	
1120-9581	Volvo S70 V70	Kit	
	Volvo 850	Kit	
1120-9582	Volvo S70 V70	Kit	
	Volvo 850	Kit	
1120-9771	Volkswagen Polo	Kit	
1120-9772	Volkswagen Polo	Kit	
1120-9811	Volkswagen Polo	Kit	
1120-9881	Volkswagen Golf 6	Kit	
<b>1140-SERIES</b>			
1140-0011	Audi Q5	Kit	
1140-0012	Audi Q5	Kit	
1140-0080	Volkswagen Golf 6	Kit	
	Volkswagen Jetta 6	Kit	
1140-0081	Volkswagen Golf 6	Kit	
	Volkswagen Jetta 6	Kit	
1140-0082	Volkswagen Golf 6	Kit	
	Volkswagen Jetta 6	Kit	
1140-0083	Volkswagen Golf 6	Kit	
1140-0084	Volkswagen Golf 6	Kit	
1140-0085	Volkswagen Golf 6	Kit	
	Volkswagen Jetta 6	Kit	
1140-0086	Volkswagen Golf 6	Kit	
	Volkswagen Jetta 6	Kit	
1140-0087	Volkswagen Golf 6	Kit	
	Volkswagen Jetta 6	Kit	
1140-0088	Volkswagen Golf 6	Kit	
1140-0089	Volkswagen Golf 6	Kit	
1140-0121	Ford Europe Fiesta	Kit	
1140-0131	Volkswagen Scirocco	Kit	
1140-0132	Volkswagen Scirocco	Kit	
1140-0181	Seat Ibi a	Kit	
1140-0182	Seat Ibi a	Kit	
1140-0183	Seat Ibi a	Kit	
1140-0184	Seat Ibi a	Kit	
1140-0231	onda Accord	Kit	
1140-0232	onda Accord	Kit	
1140-0233	onda Accord	Kit	
1140-0234	onda Accord	Kit	
1140-0331	Ma da 6 (Aten a)	Kit	
1140-0332	Ma da 6 (Aten a)	Kit	
1140-0333	Ma da 6 (Aten a)	Kit	
1140-0334	Ma da 6 (Aten a)	Kit	
1140-0461S	Subaru Impre a	Kit	
1140-0611	Audi A4	Kit	
	Audi A5	Kit	
1140-0612	Audi A4	Kit	
	Audi A5	Kit	
	Audi S4	Kit	
	Audi S5	Kit	
1140-0613	Audi A4	Kit	
	Audi A5	Kit	
1140-0614	Audi A4	Kit	
	Audi A5	Kit	
1140-0631	Ford America Mustang	Kit	
1140-0651	Ford Europe Mondeo	Kit	
1140-0652	Ford Europe Mondeo	Kit	
1140-0653	Ford Europe Mondeo	Kit	
1140-0654	Ford Europe Mondeo	Kit	
1140-0731	Skoda Fabia	Kit	
1140-0732	Skoda Fabia	Kit	
1140-0733	Skoda Fabia	Kit	

pe	Ma e Model	A le	
1140-0734	Skoda Fabia	Kit	
1140-0735	Skoda Fabia	Kit	
1140-0736	Skoda Fabia	Kit	
1140-0761	Mercedes-Ben C-Class (W204)	Kit	
1140-0762	Mercedes-Ben C-Class (W204)	Kit	
1140-0763	Mercedes-Ben C-Class (W204)	Kit	
1140-0764	Mercedes-Ben C-Class (W204)	Kit	
1140-0821	Skoda Roomster	Kit	
1140-0836	yundai I30	Kit	
1140-0861	Volvo C30	Kit	
1140-0862	Volvo C30	Kit	
1140-0901	Mini New Mini	Kit	
1140-0902	Mini New Mini	Kit	
1140-0982	Volvo S70 V70	Kit	
1140-1001	Audi S3	Kit	
1140-1021	Audi TT	Kit	
1140-1022	Audi TT	Kit	
1140-1031	Renault Clio	Kit	
1140-1032	Renault Clio	Kit	
1140-1151	Volvo C70	Kit	
1140-1241	Skoda Octavia	Kit	
1140-1242	Skoda Octavia	Kit	
1140-1301	onda Civic	Kit	
1140-1302	onda Civic	Kit	
1140-1351	Ma da M -5	Kit	
1140-1361	Alfa Romeo Brera	Kit	
	Alfa Romeo Spider	Kit	
	Alfa Romeo 159	Kit	
1140-1362	Alfa Romeo Brera	Kit	
	Alfa Romeo 159	Kit	
1140-1363	Alfa Romeo 159	Kit	
1140-1364	Alfa Romeo Brera	Kit	
	Alfa Romeo 159	Kit	
1140-1521	Ma da 5 (Premacy)	Kit	
1140-1522	Ma da 5 (Premacy)	Kit	
1140-1621	Skoda Superb	Kit	
	Volkswagen Passat	Kit	
1140-1622	Skoda Superb	Kit	
	Volkswagen Passat	Kit	
	Volkswagen Touran	Kit	
1140-1623	Skoda Superb	Kit	
	Volkswagen Passat	Kit	
1140-1624	Skoda Superb	Kit	
	Volkswagen Passat	Kit	
1140-1625	Skoda Superb	Kit	
	Volkswagen Passat	Kit	
1140-1626	Skoda Superb	Kit	
	Volkswagen Passat	Kit	
1140-1627	Volkswagen Passat	Kit	
1140-1628	Volkswagen Passat	Kit	
1140-1671	Subaru Legacy	Kit	
1140-1721	Ford America Mustang	Kit	
1140-1722	Ford America Mustang	Kit	
1140-1723	Ford America Mustang	Kit	
1140-1724	Ford America Mustang	Kit	
1140-1761	Seat Leon	Kit	
	Volkswagen Golf 5	Kit	
1140-1762	Seat Leon	Kit	
1140-1763	Volkswagen Golf 5	Kit	
1140-1791	Ma da 3 (Axela)	Kit	
1140-1821	Ford Europe Focus	Kit	
1140-1822	Ford Europe Focus	Kit	
1140-1825	Ford Europe Focus	Kit	
1140-1826	Ford Europe Focus	Kit	
1140-1827	Ford Europe Focus	Kit	
1140-1867	onda Civic	Kit	
1140-1871	BMW 3-Series E90 91 92 93	Kit	
1140-1872	BMW 3-Series E90 91 92 93	Kit	
1140-1873	BMW 1-Series E81 E82 E87 E88	Kit	
1140-1875	BMW 3-Series E90 91 92 93	Kit	
1140-1876	BMW 3-Series E90 91 92 93	Kit	
1140-1901	Renault M gane	Kit	
1140-2001	Audi A6	Kit	
1140-2002	Audi A6	Kit	
1140-2003	Audi A6	Kit	
1140-2004	Audi A6	Kit	
1140-2081	Volvo S40 V40	Kit	
1140-2082	Volvo V50	Kit	
1140-2231	Ma da R -8	Kit	
1140-2232	Ma da R -8	Kit	
1140-2271	Audi A3	Kit	
1140-2281	Ma da 3 (Axela)	Kit	
1140-2282	Ma da 3 (Axela)	Kit	
1140-2283	Ma da 3 (Axela)	Kit	
1140-2284	Ma da 3 (Axela)	Kit	
1140-2285	Ma da 3 (Axela)	Kit	
1140-2291	Ford Europe Focus	Kit	
1140-2292	Ford Europe Focus	Kit	
1140-2331	Nissan -Series	Kit	
1140-2551	BMW 5-Series E6	Kit	
1140-2552	BMW 5-Series E6	Kit	
1140-2553	BMW 5-Series E6	Kit	
1140-2554	BMW 5-Series E6	Kit	
1140-2555	BMW 5-Series E6	Kit	
1140-2556	BMW 5-Series E6	Kit	
1140-2571	Audi S4	Kit	

pe	Ma e Model	A le	
1140-2591	Mercedes-Ben CLK-Class (W209)	Kit	
1140-2592	Mercedes-Ben CLK-Class (W209)	Kit	
1140-2611	Audi A3	Kit	
	Seat Altea	Kit	
	Seat Toledo	Kit	
	Skoda Octavia	Kit	
	Volkswagen Golf 5	Kit	
	Volkswagen Jetta 5	Kit	
1140-2612	Audi A3	Kit	
	Seat Altea	Kit	
	Seat Toledo	Kit	
	Skoda Octavia	Kit	
	Volkswagen Golf 5	Kit	
	Volkswagen Jetta ( S markets only)	Kit	
	Volkswagen Jetta 5	Kit	
1140-2613	Audi A3	Kit	
	Seat Toledo	Kit	
	Skoda Octavia	Kit	
	Volkswagen Golf 5	Kit	
	Volkswagen Jetta 5	Kit	
1140-2614	Audi A3	Kit	
	Seat Altea	Kit	
	Seat Toledo	Kit	
	Skoda Octavia	Kit	
	Volkswagen Golf 5	Kit	
	Volkswagen Jetta 5	Kit	
1140-2691	BMW -Series	Kit	
1140-2743	Volkswagen Touran	Kit	
1140-2744	Volkswagen Touran	Kit	
1140-2791	Seat Cordoba	Kit	
1140-2792	Seat Cordoba	Kit	
1140-2811	onda Accord	Kit	
1140-2813	onda Accord	Kit	
1140-28878-3	BMW 4-Series (F32 F33 F36)	Kit	
1140-28878-4	BMW 4-Series (F32 F33 F36)	Kit	
1140-3111	Ma da 6 (Aten a)	Kit	
1140-3112	Ma da 6 (Aten a)	Kit	
1140-3113	Ma da 6 (Aten a)	Kit	
1140-3114	Ma da 6 (Aten a)	Kit	
1140-3241	Mercedes-Ben E-Class (W211)	Kit	
1140-3242	Mercedes-Ben E-Class (W211)	Kit	
1140-3243	Mercedes-Ben E-Class (W211)	Kit	
1140-3244	Mercedes-Ben E-Class (W211)	Kit	
1140-3321	onda Civic	Kit	
1140-3331	Seat Ibi a	Kit	
	Volkswagen Fox	Kit	
	Volkswagen Polo	Kit	
1140-3332	Seat Ibi a	Kit	
	Volkswagen Polo	Kit	
1140-3333	Seat Ibi a	Kit	
	Volkswagen Polo	Kit	
1140-3432	Mini New Mini	Kit	
1140-3561	Subaru Impre a	Kit	
1140-3562	Subaru Impre a	Kit	
1140-3563	Subaru Impre a	Kit	
1140-3591	onda Civic	Kit	
1140-3592	onda Civic	Kit	
1140-3593	onda Civic	Kit	
1140-3594	onda Civic	Kit	
1140-3601	Alfa Romeo GT	Kit	
	Alfa Romeo 147	Kit	
1140-3602	Alfa Romeo GT	Kit	
	Alfa Romeo 147	Kit	
1140-3603	Alfa Romeo GT	Kit	
	Alfa Romeo 147	Kit	
1140-3611	Volvo S60 V60	Kit	
1140-3641	BMW M3	Kit	
1140-3681	Audi A4	Kit	
1140-3682	Audi A4	Kit	
1140-3691	Audi A4	Kit	
	Seat Exeo	Kit	
1140-3692	Audi A4	Kit	
	Seat Exeo	Kit	
1140-3771	Mercedes-Ben C-Class (W202)	Kit	
	Mercedes-Ben CLK-Class (W208)	Kit	
1140-3881	Audi A2	Kit	
1140-3882	Audi A2	Kit	
1140-3921	Mercedes-Ben C-Class (W203)	Kit	
	Mercedes-Ben CLC-Class (CL203)	Kit	
	Mercedes-Ben CLK-Class (W209)	Kit	
	Mercedes-Ben C-Class (W203)	Kit	
1140-3922	Mercedes-Ben CLK-Class (W209)	Kit	
1140-3923	Mercedes-Ben C-Class (W203)	Kit	
1140-3991	Toyota MR2	Kit	
1140-4091	Skoda Fabia	Kit	
1140-4092	Skoda Fabia	Kit	
1140-4141	Toyota Celica	Kit	
1140-4171	onda S2000	Kit	
1140-4191	BMW 3-Series E46	Kit	
1140-4192	BMW 3-Series E46	Kit	
1140-4310	Volkswagen Golf 7	Kit	
1140-4321	Toyota Supra	Kit	
1140-4351	Lexus IS	Kit	
1140-4352	Lexus IS	Kit	
1140-4353	Lexus IS	Kit	
1140-4354	Lexus IS	Kit	
1140-4381	Volkswagen Bora	Kit	

pe	Ma e Model	A le	
1140-4382	Volkswagen Golf 4	Kit	
	Audi A3	Kit	
	Seat Leon	Kit	
	Volkswagen Bora	Kit	
	Volkswagen Golf 4	Kit	
1140-4383	Audi S3	Kit	
1140-4385	Audi TT	Kit	
1140-4391	Volkswagen Bora	Kit	
	Volkswagen Golf 4	Kit	
1140-4392	Volkswagen Bora	Kit	
	Volkswagen Golf 4	Kit	
1140-4411	BMW M5	Kit	
1140-4421	Toyota aris Echo Vit	Kit	
1140-4521	Volvo S70 V70	Kit	
1140-4531	Audi TT	Kit	
1140-4532	Audi TT	Kit	
1140-4691	Peugeot 206	Kit	
	Peugeot 206+	Kit	
1140-4692	Peugeot 206	Kit	
1140-4771	Audi S4	Kit	
1140-4772	Audi S4	Kit	
1140-4841	BMW 3-Series E46	Kit	
1140-4851	BMW 3-Series E46	Kit	
1140-4852	BMW 3-Series E46	Kit	
1140-4871	Ma da M -5	Kit	
1140-4951	Saab 9-3	Kit	
1140-5021	onda Integra	Kit	
1140-5051	Alfa Romeo 156	Kit	
1140-5052	Alfa Romeo 156	Kit	
1140-5131	Porsche 911 (912)	Kit	
1140-5132	Porsche 911 (912)	Kit	
1140-5151	Citroen sara	Kit	
1140-5201	BMW -Series	Kit	
1140-5261	Seat Leon	Kit	
	Seat Toledo	Kit	
	Volkswagen Bora	Kit	
	Volkswagen Golf 4	Kit	
1140-5262	Seat Leon	Kit	
	Seat Toledo	Kit	
	Volkswagen Bora	Kit	
	Volkswagen Golf 4	Kit	
1140-5301	Opel Astra	Kit	
1140-5302	Opel Astra	Kit	
1140-5403	Volkswagen Golf 1	Kit	
1140-5404	Volkswagen Golf 1	Kit	
1140-5412	Volkswagen Golf 2	Kit	
	Volkswagen Jetta 2	Kit	
1140-5981	Porsche 911 (912)	Kit	
1140-6322	Volkswagen Golf 2	Kit	
	Volkswagen Jetta 2	Kit	
1140-7061	Volkswagen Corrado	Kit	
1140-7221	BMW 3-Series E36	Kit	
1140-7222	BMW 3-Series E36	Kit	
1140-7241	Mercedes-Ben E-Class (W210)	Kit	
1140-7242	Mercedes-Ben E-Class (W210)	Kit	
1140-7361	onda Civic	Kit	
1140-7421	BMW 5-Series E39	Kit	
1140-7423	BMW 5-Series E39	Kit	
1140-7491	Mercedes-Ben C-Class (W202)	Kit	
	Mercedes-Ben CLK-Class (W208)	Kit	
1140-7492	Mercedes-Ben C-Class (W202)	Kit	
	Mercedes-Ben CLK-Class (W208)	Kit	
1140-7493	Mercedes-Ben CLK-Class (W208)	Kit	
1140-7494	Mercedes-Ben CLK-Class (W208)	Kit	
1140-7541	BMW -Series	Kit	
1140-7542	BMW -Series	Kit	
1140-7571	Citroen Saxo	Kit	
	Peugeot 106	Kit	
1140-7641	BMW 5-Series E39	Kit	
1140-7642	BMW 5-Series E39	Kit	
1140-7643	BMW 5-Series E39	Kit	
1140-7671	Audi A3	Kit	
	Skoda Octavia	Kit	
1140-7672	Audi A3	Kit	
	Skoda Octavia	Kit	
1140-7673	Skoda Octavia	Kit	
1140-7674	Skoda Octavia	Kit	
1140-7691	Chrysler America Crossfire	Kit	
	Mercedes-Ben SLK-Class (R170)	Kit	
1140-7731	Volkswagen Passat	Kit	
1140-7732	Volkswagen Passat	Kit	
1140-7733	Volkswagen Passat	Kit	
1140-7791	Porsche Boxster	Kit	
1140-7861	Citroen Saxo	Kit	
	Peugeot 106	Kit	
1140-7911	BMW 5-Series E39	Kit	
1140-7931	Audi A6	Kit	
	Skoda Superb	Kit	
1140-7932	Audi A6	Kit	
	Skoda Superb	Kit	
1140-7941	Volkswagen Passat	Kit	
1140-7942	Volkswagen Passat	Kit	
1140-7943	Volkswagen Passat	Kit	
1140-7951	Volkswagen Passat	Kit	
1140-7961	Audi A6	Kit	
1140-7962	Audi A6	Kit	

pe	Ma e Model	A le	
1140-7971	Audi A6	Kit	
1140-7972	Audi A6	Kit	
1140-7973	Audi A6	Kit	
1140-7974	Audi A6	Kit	
1140-7981	Audi A6	Kit	
1140-7982	Audi A6	Kit	
1140-7983	Audi A6	Kit	
1140-7984	Audi A6	Kit	
1140-8111	Mercedes-Ben C-Class (W205)	Kit	
1140-8112	Mercedes-Ben C-Class (W205)	Kit	
1140-8113	Mercedes-Ben C-Class (W205)	Kit	
1140-8114	Mercedes-Ben C-Class (W205)	Kit	
1140-8131	Porsche 911 (912)	Kit	
1140-8161	Volkswagen Golf 7	Kit	
1140-8162	Volkswagen Golf 7	Kit	
1140-8211	Ma da 3 (Axela)	Kit	
1140-8212	Ma da 3 (Axela)	Kit	
1140-8242	BMW 3-Series E36	Kit	
1140-8310	yundai I30	Kit	
1140-8311	yundai I30	Kit	
1140-8341	Porsche 911 (912)	Kit	
1140-8381	Ma da 6 (Aten a)	Kit	
1140-8382	Ma da 6 (Aten a)	Kit	
1140-8383	Ma da 6 (Aten a)	Kit	
1140-8384	Ma da 6 (Aten a)	Kit	
1140-8385	Ma da 6 (Aten a)	Kit	
1140-8386	Ma da 6 (Aten a)	Kit	
1140-8391	Ma da M -5	Kit	
1140-8401	Volkswagen Golf 7	Kit	
1140-8402	Volkswagen Golf 7	Kit	
1140-8403-1	Volkswagen Golf 7	Kit	
1140-8403	Volkswagen Golf 7	Kit	
1140-8404-1	Volkswagen Golf 7	Kit	
1140-8404	Volkswagen Golf 7	Kit	
1140-8405-1	Volkswagen Golf 7	Kit	
1140-8405	Volkswagen Golf 7	Kit	
1140-8406-1	Volkswagen Golf 7	Kit	
1140-8406	Volkswagen Golf 7	Kit	
1140-8431-1	Seat Leon	Kit	
	Volkswagen Golf 7	Kit	
1140-8431	Seat Leon	Kit	
	Volkswagen Golf 7	Kit	
1140-8432-1	Seat Leon	Kit	
	Volkswagen Golf 7	Kit	
1140-8432	Seat Leon	Kit	
	Volkswagen Golf 7	Kit	
1140-8433-1	Seat Leon	Kit	
	Volkswagen Golf 7	Kit	
1140-8433	Seat Leon	Kit	
	Volkswagen Golf 7	Kit	
1140-8434-1	Seat Leon	Kit	
	Volkswagen Golf 7	Kit	
1140-8434	Seat Leon	Kit	
	Volkswagen Golf 7	Kit	
1140-8435-1	Seat Leon	Kit	
	Volkswagen Golf 7	Kit	
1140-8435	Seat Leon	Kit	
	Volkswagen Golf 7	Kit	
1140-8436-1	Seat Leon	Kit	
	Volkswagen Golf 7	Kit	
1140-8436	Seat Leon	Kit	
	Volkswagen Golf 7	Kit	
1140-8561	Scion FR-S	Kit	
	Subaru BR	Kit	
	Toyota GT86	Kit	
	Toyota 86	Kit	
1140-8584	Mercedes-Ben CLA-Class ( 117)	Kit	
1140-8605	Audi A3	Kit	
1140-8606	Audi A3	Kit	
1140-8631	onda Civic	Kit	
1140-8632	onda Civic	Kit	
1140-8661	Kia Cee d	Kit	
1140-8662	Kia Cee d	Kit	
1140-8663	Kia Cee d	Kit	
1140-8664	Kia Cee d	Kit	
1140-8711	Peugeot 106	Kit	
1140-8721	Volkswagen Corrado	Kit	
1140-8722	Volkswagen Golf 3	Kit	
	Volkswagen Vento	Kit	
1140-8751	Ma da C -5	Kit	
1140-8752	Ma da C -5	Kit	
1140-8764-1	Ma da M -5	Kit	
1140-8779-1	Ford Europe Mustang	Kit	
1140-8832-1	BMW 3-Series F30 F31 F34	Kit	
1140-8832-2	BMW 3-Series F30 F31 F34	Kit	
1140-8841	Toyota MR2	Kit	
1140-8861	Opel Astra	Kit	
1140-8862	Opel Astra	Kit	
1140-8878-1	BMW 3-Series F30 F31 F34	Kit	
	BMW 4-Series (F32 F33 F36)	Kit	
1140-8878-2	BMW 3-Series F30 F31 F34	Kit	
	BMW 4-Series (F32 F33 F36)	Kit	
1140-8878-3	BMW 3-Series F30 F31 F34	Kit	
1140-8878-4	BMW 3-Series F30 F31 F34	Kit	
1140-8881-1	Mercedes-Ben A-Class (W176), B-Class (W246)	Kit	
1140-8881-2	Mercedes-Ben A-Class (W176), B-Class (W246)	Kit	

pe	Ma e Model	A le	
1140-8881-3	Mercedes-Ben CLA-Class (C117)	Kit	
1140-8881-4	Mercedes-Ben CLA-Class (C117)	Kit	
1140-8893	Volvo S60 V60	Kit	
1140-8894	Volvo S60 V60	Kit	
1140-8896-1	BMW 1-Series F20 F21	Kit	
	BMW 2-Series F22	Kit	
1140-8898	Volvo S60 V60	Kit	
1140-8899	Volvo S60 V60	Kit	
1140-8931-1	Su uki Swift	Kit	
1140-8931-2	Su uki Swift	Kit	
1140-8973	Volkswagen New Beetle	Kit	
1140-8976-1	Opel Astra	Kit	
1140-8976-2	Opel Astra	Kit	
1140-8976-3	Opel Astra	Kit	
1140-8976-4	Opel Astra	Kit	
1140-8991	Kia Rio III	Kit	
1140-9011	Citroen A	Kit	
1140-9021	yundai Veloster	Kit	
1140-9091	Audi S2	Kit	
1140-9101	BMW M3	Kit	
1140-9102	BMW M3	Kit	
1140-9135-1	Fiat 124	Kit	
1140-9171	Audi A6	Kit	
	Audi A7	Kit	
1140-9172	Audi A6	Kit	
	Audi A7	Kit	
1140-9173	Audi A6	Kit	
	Audi A7	Kit	
1140-9174	Audi A6	Kit	
	Audi A7	Kit	
1140-9175	Audi A6	Kit	
1140-9176	Audi A6	Kit	
1140-9261	Mercedes-Ben C-Class (W202)	Kit	
1140-9271	Mercedes-Ben C-Class (W202)	Kit	
1140-9273	Ford Europe Focus	Kit	
1140-9274	Ford Europe Focus	Kit	
1140-9291	BMW 3-Series E36	Kit	
1140-9292	BMW 3-Series E36	Kit	
1140-9331	Seat Alhambra	Kit	
	Volkswagen Sharan	Kit	
1140-9441	Audi A1	Kit	
1140-9442	Audi A1	Kit	
1140-9471	BMW 5-Series F	Kit	
1140-9472	BMW 5-Series F	Kit	
1140-9473	BMW 5-Series F	Kit	
1140-9476	BMW 5-Series F	Kit	
1140-9481	Volkswagen Golf 6	Kit	
1140-9531	Porsche 911 (912)	Kit	
1140-9589	Infiniti G-series	Kit	
1140-9649	Nissan -Series	Kit	
1140-9691	Audi RS2	Kit	
1140-9761	Fiat Coup	Kit	
1140-9762	Fiat Coup	Kit	
1140-9771	Volkswagen Polo	Kit	
1140-9772	Volkswagen Polo	Kit	
1140-9831	Ford Europe Focus	Kit	
1140-9871	BMW -Series	Kit	
1140-9881	Volkswagen Golf 6	Kit	
1140-9982	Opel Cascada	Kit	
1140-9986	Opel Cascada	Kit	
<b>1150-SERIES</b>			
1150-5001-1	Volkswagen Golf 2	Kit	
	Volkswagen Jetta 2	Kit	
1150-5002-1	Volkswagen Corrado	Kit	
	Volkswagen Golf 3	Kit	
	Volkswagen Vento	Kit	
1150-5006-1	onda Civic	Kit	
1150-5080-1	Audi A3	Kit	
	Seat Altea	Kit	
	Seat Leon	Kit	
	Seat Toledo	Kit	
	Volkswagen Golf 5	Kit	
	Volkswagen Golf 6	Kit	
	Volkswagen Jetta ( S markets only)	Kit	
	Volkswagen Jetta 5	Kit	
	Volkswagen Jetta 6	Kit	
	Volkswagen Scirocco	Kit	
<b>1250-SERIES</b>			
1250-1001	Seat Leon	Kit	
	Volkswagen Golf 7	Kit	
<b>2100-SERIES</b>			
2100-4074	olden (Australia) Commodore	Kit	
<b>25-SERIES</b>			
25-1215	Ford America Mustang	Rear	E E
<b>26-SERIES</b>			
26-1019	Mercedes-Ben (W114) (W115)	Front	P E
	Mercedes-Ben SL-Class (R107)	Front	P E
26-1087	Saab 90	Rear	P E
	Saab 900	Rear	P E
	Saab 99	Rear	P E
26-1089	Daimler Double six	Front	P E
	Daimler Sovereign	Front	P E



pe	Ma e Model	A le	🔑
26-1129Sport	Jaguar J	Front	PE
26-1157	Jaguar J-S	Front	PE
	Volvo 240-, 260-series	Rear	EE
	Mercedes-Ben E-Class (W123)	Front	PE
	Mercedes-Ben S-Class (W116)	Front	PE
	Mercedes-Ben S-Class (W126) (C126)	Front	PE
26-1198Sport	Mercedes-Ben E-Class (W124) (C124)	Rear	PE
	Mercedes-Ben 190-series (W201)	Rear	PE
26-1209Sport	Porsche 924	Rear	EE
	Porsche 944	Rear	EE
26-1248Sport	Nissan -Series	Rear	PE
26-1294Sport	Ford Europe Escort	Rear	EE
	Ford Europe Sierra	Rear	EE
26-1299Sport	Renault R5	Rear	EE
▲26-1369	Su uki SJ	Rear	EE
26-1481Sport	Citroen A	Rear	EE
	Citroen Saxo	Rear	EE
	Peugeot 106	Rear	EE
26-1486Sport	Citroen sara	Rear	EE
	Citroen	Rear	EE
	Peugeot 306	Rear	EE
26-1487Sport	Citroen sara	Rear	EE
	Citroen	Rear	EE
	Peugeot 306	Rear	EE
26-1575Sport	Mercedes-Ben C-Class (W202)	Front	PE
	Mercedes-Ben CLK-Class (W208)	Front	PE
26-1576Sport	Mercedes-Ben C-Class (W202)	Rear	PE
	Mercedes-Ben CLK-Class (W208)	Rear	PE
26-1592	Daimler Double six	Front	PE
	Jaguar J	Front	PE
▲26-1621	Ssang ong Korando	Front	PE
	Ssang ong Musso	Front	PE
▲26-1622	Ssang ong Korando	Rear	PE
	Ssang ong Musso	Rear	PE
26-1647	Renault Avantage	Rear	EE
	Renault Espace	Rear	EE
26-1653Sport	Citroen C2	Rear	EE
	Peugeot 206	Rear	EE
	Peugeot 206+	Rear	EE
26-1698	Jaguar J	Front	PE
<b>30-SERIES</b>			
30-1020	Mercedes-Ben (W114) (W115)	Rear	PE
	Mercedes-Ben E-Class (W123)	Rear	PE
	Mercedes-Ben S-Class (W116)	Rear	PE
	Mercedes-Ben S-Class (W126) (C126)	Rear	PE
	Mercedes-Ben SL-Class (R107)	Rear	PE
30-1088	Saab 900	Front	PE
30-1090	Daimler Double six	Rear	EE
	Daimler Sovereign	Rear	EE
	Jaguar J	Rear	EE
	Jaguar J-S	Rear	EE
30-1265Sport	Chevrolet Camaro	Rear	PE
	Pontiac Firebird	Rear	PE
▲30-1268	Toyota Landcruiser	Front	PP
▲30-1269L	Toyota Landcruiser	Rear	PE
▲30-1270R	Toyota Landcruiser	Rear	EE
30-1311SP1	Land Rover (Range-Rover) Discovery	Front	PP
30-1311	Land Rover (Range-Rover) Discovery	Front	PP
	Land Rover (Range-Rover) Land Rover (Defender)	Front	PP
	Land Rover (Range-Rover) Range Rover	Front	PP
30-1312SP1	Land Rover (Range-Rover) Discovery	Rear	EP
30-1312	Land Rover (Range-Rover) Discovery	Rear	EP
	Land Rover (Range-Rover) Land Rover (Defender)	Rear	EP
	Land Rover (Range-Rover) Range Rover	Rear	EP
30-1314Sport	Peugeot 205	Rear	EE
	Peugeot 309	Rear	EE
30-1318	yundai Galloper	Front	PE
	Mitsubishi L200	Front	PE
	Mitsubishi L300	Front	PE
	Mitsubishi Pajero	Front	PE
30-1322	Mercedes-Ben G-Series (W460) (W461) (W463)	Front	EP
30-1323	Mercedes-Ben G-Series (W460) (W461) (W463)	Rear	PE
30-1324	Lada Niva	Front	PE
30-1325	Lada Niva	Rear	EE
30-1326	olden (Australia) Jackaroo	Front	PE
	yundai 100	Front	PE
	Isu u Trooper	Front	PE
	Mitsubishi L200	Front	PE
30-1342	Nissan King Cab	Front	PE
	Nissan Navara	Front	PE
30-1343	Nissan King Cab	Rear	EE
	Nissan Navara	Rear	EE
30-1348	Jeep Cherokee	Front	PE
	Jeep Wrangler	Front	PE
30-1365	Ford Europe Maverick	Front	PE
	olden (Australia) Jackaroo	Front	PE
	olden (Australia) Rodeo	Front	PE
	onda Passport	Front	PE
	yundai 200	Front	PE
	Isu u Campo	Front	PE
	Isu u Rodeo	Front	PE
	Isu u Trooper	Front	PE
	Mitsubishi L400	Front	PE
	Nissan Pathfinder	Front	PE
	Nissan Terrano	Front	PE

pe	Ma e Model	A le	🔑
30-1372	Opel Campo	Front	PE
	Opel Frontera	Front	PE
	Vauxhall (See also Opel) Frontera	Front	PE
	Ford Europe Maverick	Rear	EE
	Nissan Pathfinder	Rear	EE
	Nissan Patrol	Rear	EE
	Nissan Terrano	Rear	EE
30-1379	Ford Australia Maverick	Front	PP
	Nissan Patrol	Front	PP
30-1380	Ford Australia Maverick	Rear	EE
	Nissan Patrol	Rear	EE
30-1407	Toyota Australia i-Lux	Rear	EE
	Toyota i-Lux	Rear	EE
	Toyota Landcruiser	Rear	EE
	Volkswagen Taro	Rear	EE
▲30-1408	yundai Galloper	Rear	EE
	yundai 200	Rear	EE
	Mitsubishi Pajero	Rear	EE
30-1417	Toyota i-Ace	Front	PE
30-1418	Toyota i-Ace	Rear	EE
30-1422	Toyota 4-Runner	Rear	PE
30-1426	Lexus L	Front	PP
	Toyota Landcruiser	Front	PP
	Lexus L	Rear	PE
30-1427	Toyota Landcruiser	Rear	PE
30-1456	Mitsubishi Challenger	Front	PE
	Mitsubishi Pajero	Front	PE
	Mitsubishi Triton	Front	PE
30-1457	Mitsubishi Pajero	Rear	PE
30-1459	Mitsubishi L200	Rear	EE
	Mitsubishi Triton	Rear	EE
30-1479Sport	Volvo 740	Rear	EE
	Volvo 760	Rear	EE
	Volvo 940	Rear	EE
	Volvo 960	Rear	EE
30-1500	Opel Frontera	Rear	EE
30-1565	Vauxhall (See also Opel) Frontera	Rear	EE
	olden (Australia) Frontera	Front	PE
	olden (Australia) Jackaroo	Front	PE
	olden (Australia) Rodeo	Front	PE
	Isu u Trooper	Front	PE
	Opel Frontera	Front	PE
	Opel Monterey	Front	PE
	Vauxhall (See also Opel) Frontera	Front	PE
	Vauxhall (See also Opel) Monterey	Front	PE
	olden (Australia) Frontera	Rear	EE
	olden (Australia) Jackaroo	Rear	EE
	Isu u Trooper	Rear	EE
	Opel Frontera	Rear	EE
	Opel Monterey	Rear	EE
	Vauxhall (See also Opel) Frontera	Rear	EE
	Vauxhall (See also Opel) Monterey	Rear	EE
▲30-1583Sport	Toyota Supra	Front	PE
▲30-1584Sport	Toyota Supra	Rear	EB
30-1588	Ford Europe Maverick	Front	PE
	Nissan Terrano	Front	PE
▲30-1593	Daimler Double six	Rear	PE
	Daimler Six	Rear	PE
	Jaguar J	Rear	PE
30-1597	Land Rover (Range-Rover) Range Rover	Front	EP
30-1598	Land Rover (Range-Rover) Range Rover	Rear	EP
30-1599Sport	Toyota RAV4	Rear	PE
30-1608Sport	Alfa Romeo GTV	Rear	EB
30-1630	Jeep Cherokee	Rear	EE
	Jeep Wrangler	Rear	EE
30-1663	olden (Australia) Frontera	Front	PE
	onda Passport	Front	PE
	Isu u Rodeo	Front	PE
	Opel Frontera	Front	PE
30-1664	Vauxhall (See also Opel) Frontera	Front	PE
	olden (Australia) Frontera	Rear	PE
	olden (Australia) Rodeo	Rear	PE
	onda Passport	Rear	PE
	Isu u Rodeo	Rear	PE
	Opel Frontera	Rear	PE
30-1703	Vauxhall (See also Opel) Frontera	Rear	PE
	Chevrolet Niva	Front	PE
30-1704	Lada Niva	Front	PE
	Chevrolet Niva	Rear	EE
	Lada Niva	Rear	EE
30-1705	Mitsubishi Challenger	Rear	EE
	Mitsubishi Pajero	Rear	EE
<b>3013-SERIES</b>			
3013-1023Sport	Chevrolet Corvette	Front	PE
3013-1024Sport	Chevrolet Corvette	Rear	PE
<b>76-SERIES</b>			
76-1099	Porsche 356	Front	EE
<b>80-SERIES</b>			
80-1005	Triumph TR-series	Front	PE
80-1011	Porsche 356	Rear	EE
80-1013	Porsche 356	Front	EE
80-1021	Morgan Morgan	Front	PE
80-1039	Alfa Romeo Giulia	Front	PP
	Alfa Romeo Giulietta	Front	PP

pe	Make Model	Align	Key
80-1044SP20	Porsche 356	Front	EE
80-1092	Mercedes-Ben 180, 180D, 190, 190D, 190B DB	Front	PP
	Mercedes-Ben 219, 220, 220A, 220S	Front	PP
80-1104	Mercedes-Ben 180, 180D, 190, 190D, 190B DB	Rear	PP
	Mercedes-Ben 219, 220, 220A, 220S	Rear	PP
80-1105	Jaguar K	Front	PE
80-1114	Citroen Traction Avant	Front	EE
80-1191SP20	Porsche 356	Rear	PE
80-1193	Alfa Romeo Giulia	Rear	PE
	Alfa Romeo Giulietta	Rear	PE
80-1196	Citroen Traction Avant	Front	EE
		Rear	EE
80-1244SP1	MG MG-B	Rear	EE
	MG MG-C	Rear	EE
80-1307	Fiat 500	Rear	PP
80-1308	Fiat 500	Front	PP
80-1319	Volvo Ama on	Front	PP
80-1320	Volvo Ama on	Rear	PP
80-1349	Volkswagen Beetle	Front	EE
	Volkswagen Commercials	Front	EE
	Volkswagen Karmann Ghia	Front	EE
80-1350Sport	Volkswagen Beetle	Rear	EE
	Volkswagen Karmann Ghia	Rear	EE
80-1350	Volkswagen Beetle	Rear	EE
	Volkswagen Commercials	Rear	EE
	Volkswagen Karmann Ghia	Rear	EE
80-1388	Triumph GT6	Front	PE
	Triumph erald	Front	PE
	Triumph Spitfire	Front	PE
	Triumph Vitesse	Front	PE
80-1389	Triumph GT6	Rear	EE
	Triumph erald	Rear	EE
	Triumph Spitfire	Rear	EE
	Triumph Vitesse	Rear	EE
80-1415	Mercedes-Ben (W111)	Front	PE
	Mercedes-Ben S-Class (W108) (W109)	Front	PE
	Mercedes-Ben SL-Class (W113)	Front	PE
80-1416	Mercedes-Ben (W111)	Rear	PE
	Mercedes-Ben S-Class (W108) (W109)	Rear	PE
	Mercedes-Ben SL-Class (W113)	Rear	PE
80-1491SPA1	Jaguar E-type	Rear	EE
80-1500	Lancia Flavia	Front	PE
80-1501	Lancia Fulvia	Front	PE
	Lancia Flavia	Rear	EE
	Lancia Fulvia	Rear	EE
80-1538	Dodge Challenger	Front	PE
	Dodge Charger	Front	PE
	Plymouth Barracuda	Front	PE
	Plymouth Belvedere	Front	PE
	Plymouth Road Runner	Front	PE
80-1551Sport	Alfa Romeo Giulia	Front	PE
	Alfa Romeo Montreal	Front	PE
	Alfa Romeo Spider	Front	PE
80-1551	Alfa Romeo Giulia	Front	PE
	Alfa Romeo Spider	Front	PE
80-1573	Morgan Morgan	Rear	EE
80-1580Sport	Opel GT	Front	PE
	Opel Kadett	Front	PE
80-1580	Opel GT	Front	PE
	Opel Kadett	Front	PE
80-1675Sport	Mini Mini Classic	Front	EE
80-1675	Mini Mini Classic	Front	EE
80-1689	Volga series 3102, 31029, 31022-2.4	Front	PE
80-1690	Volga series 3102, 31029, 31022-2.4	Rear	PE
80-1717	Mini Mini Classic	Front	EE
80-1743SP3	Renault Alpine	Front	PE
	Renault R8	Front	PE
80-1744SP3	Renault Alpine	Rear	PE
	Renault R8	Rear	PE
80-1781Sport	Alfa Romeo Giulia	Rear	PP
	Alfa Romeo Montreal	Rear	PP
	Alfa Romeo Spider	Rear	PP
80-1781	Alfa Romeo Giulia	Rear	PP
	Alfa Romeo Spider	Rear	PP
80-1784	Triumph TR-series	Front	PE
80-1787	Volkswagen Beetle	Front	PE
	Volkswagen Karmann Ghia	Front	PE
80-1794Sport	Mini Mini Classic	Rear	PE
80-1794	Mini Mini Classic	Rear	PE
80-1795	Mini Mini Classic	Rear	PE
80-1868Sport	BMW 02-Series 114 E10 E20	Rear	PE
80-1877Sport	Fiat 124	Front	PE
	Seat 124 Spider	Front	PE
80-1878Sport	Fiat 124	Rear	PE
	Fiat 131	Rear	PE
	Seat 124 Spider	Rear	PE
80-1904	olden (Australia) Rodeo	Rear	EE
	Isu u Van	Rear	EE
	Mitsubishi L300	Rear	EE
	Nissan Sunny	Rear	EE
	Toyota i-Ace	Rear	EE
	Toyota Landcruiser	Front	EE
80-1905	Toyota Landcruiser	Rear	EE
80-1914	Chevrolet Camaro	Front	PE
	Pontiac Firebird	Front	PE
80-1915	Chevrolet Camaro	Rear	PE

pe	Make Model	Align	Key
	Pontiac Firebird	Rear	PE
	Chevrolet Camaro	Rear	PE
80-1953	Pontiac Firebird	Rear	PE
	Volkswagen Commercials	Front	EE
80-1966	Volkswagen Commercials	Rear	EE
80-1967	Opel GT	Rear	PE
80-1997Sport	Opel Kadett	Rear	PE
	Vauxhall (See also Opel) Chevette	Rear	PE
	Bedford Chevanne	Rear	PE
80-1997	Opel Commodore	Rear	PE
	Opel GT	Rear	PE
	Opel Kadett	Rear	PE
	Vauxhall (See also Opel) Chevette	Rear	PE
	Simca 1000 Rallye II	Front	PE
80-2021SPF1	Porsche 911 (912)	Rear	PE
80-2088	Volkswagen Commercials	Front	EE
80-2110	Ford Australia Falcon Fairmont -Series	Rear	PP
80-2111	Bedford Blit	Front	PP
▲80-2119	Bedford CF	Front	PP
	olden (Australia) E-, F- and -series	Front	PE
80-2133	Bedford CF	Rear	PE
80-2134	Ford Australia Bronco	Front	PE
	olden (Australia) E-, F- and -series	Rear	PE
	olden (Australia) Gemini	Rear	PE
	olden (Australia) Torana	Rear	PE
80-2149Sport	Volkswagen Beetle	Rear	EE
	Volkswagen Karmann Ghia	Rear	EE
80-2149	Volkswagen Beetle	Rear	EE
	Volkswagen Karmann Ghia	Rear	EE
80-2153	olden (Australia) Torana	Front	EE
80-2156SP1	olden (Australia) E-, F- and -series	Front	PE
	olden (Australia) Statesman	Front	PE
	olden (Australia) Torana	Front	PE
80-2157SP1	olden (Australia) E-, F- and -series	Rear	PE
	olden (Australia) Statesman	Rear	PE
80-2163	Chrysler Australia Valiant	Rear	EE
80-2167	Ford America Pinto	Rear	PP
	Mercury Bobcat	Rear	PP
80-2215	Jaguar E-type	Front	EE
80-2216	Jaguar E-type	Rear	EE
80-2220	Mercedes-Ben Commercials	Front	EE
	Volkswagen Commercials	Rear	EE
80-2233SP1	olden (Australia) Commodore	Rear	PE
	olden (Australia) Pia a	Rear	PE
80-2241Sport	Alfa Romeo Alfetta	Front	PE
	Alfa Romeo Giulietta	Front	PE
80-2242Sport	Alfa Romeo Alfetta	Rear	PP
	Alfa Romeo Giulietta	Rear	PP
	Ford Europe Capri	Rear	PE
80-2256Sport	Bedford Chevanne	Front	PE
80-2275	olden (Australia) Gemini	Front	PE
	olden (Australia) Pia a	Front	PE
	Isu u Gemini	Front	PE
	Opel Ascona	Front	PE
	Opel Kadett	Front	PE
	Opel Manta	Front	PE
	Vauxhall (See also Opel) Cavalier	Front	PE
	Vauxhall (See also Opel) Chevette	Front	PE
80-2299	olden (Australia) Torana	Rear	PE
	Nissan Australia 160 - 180 - 200	Rear	PE
80-2307Sport	Volkswagen Golf 1	Rear	PE
	Volkswagen Jetta 1	Rear	PE
	Volkswagen Scirocco	Rear	PE
80-2311	Chrysler Australia Valiant	Front	PE
80-2315Sport	Audi 50	Rear	PE
	Volkswagen Derby	Rear	PE
	Volkswagen Polo	Rear	PE
80-2319	Ford Australia Cortina	Rear	PP
	Ford Australia Falcon Fairmont E-series	Rear	PP
	Ford Australia Falcon Fairmont -Series	Rear	PP
	Ford Australia Galaxie	Rear	PP
80-2320	olden (Australia) E-, F- and -series	Rear	EE
80-2437Sport	Daihatsu Charmant	Rear	PE
	Toyota Corolla	Rear	PE
80-2458	Chevrolet L V	Rear	EE
	Dodge D50	Rear	EE
	Isu u Pickup	Rear	EE
	Mitsubishi L200	Rear	EE
	Toyota Dyna	Rear	EE
80-2513SP1	Ford Australia Falcon Fairmont A -series	Rear	PE
	Ford Australia Falcon Fairmont E-series	Rear	PE
	Ford Australia Falcon Fairmont -Series	Rear	PE
80-2513	Ford Australia Fairlane LTD	Rear	PE
	Ford Australia Falcon Fairmont A -series	Rear	PE
	Ford Australia Falcon Fairmont E-series	Rear	PE
	Ford Australia Falcon Fairmont -Series	Rear	PE
80-2522Sport	BMW -Series	Rear	PE
	BMW 3-Series E30	Rear	PE
	BMW 3-Series E36	Rear	PE
80-2522SP1	BMW M3	Rear	PE
	BMW 3-Series E30	Rear	PE
80-2542Sport	Seat Toledo	Rear	PE
	Volkswagen Golf 2	Rear	PE
	Volkswagen Golf 3	Rear	PE
	Volkswagen Jetta ( S markets only)	Rear	PE
	Volkswagen Jetta 2	Rear	PE

pe	Ma e Model	A le	🔑
80-2570Sport	Volkswagen Vento	Rear	P E
	Alfa Romeo Alfetta	Front	P E
	Alfa Romeo 75	Front	P E
	Alfa Romeo 90	Front	P E
80-2571Sport	Alfa Romeo Alfetta	Rear	P P
	Alfa Romeo 75	Rear	P P
	Alfa Romeo 90	Rear	P P
80-2584	Fiat Panda	Rear	E E
	Lancia psilon	Rear	E E
80-2586	Lada Diva	Rear	P E
	Lada Samara	Rear	P E
80-2587Sport	Seat Toledo	Rear	P E
	Volkswagen Corrado	Rear	P E
	Volkswagen Golf 2	Rear	P E
	Volkswagen Golf 3	Rear	P E
	Volkswagen Jetta 2	Rear	P E
	Volkswagen Vento	Rear	P E
80-2591Sport	Cadillac Catera	Rear	P E
	Opel Omega	Rear	P E
	Opel Senator	Rear	P E
	Opel Vectra	Rear	P E
	Vauxhall (See also Opel) Carlton	Rear	P E
	Vauxhall (See also Opel) Cavalier	Rear	P E
	Vauxhall (See also Opel) Omega	Rear	P E
	Vauxhall (See also Opel) Senator	Rear	P E
80-2597	olden (Australia) Commodore	Rear	P E
80-2630Sport	Audi A6	Rear	P E
	Audi S4	Rear	P E
	Audi S6	Rear	P E
	Audi V8	Rear	P E
	Audi 100	Rear	P E
	Audi 200	Rear	P E
80-2641Sport	BMW 3-Series E30	Rear	P E
	BMW 3-Series E36	Rear	P E
80-2653	BMW 3-Series E36	Rear	P E
80-2716	MG MG-B	Front	E E
80-2725	Morgan Morgan	Rear	E E
80-2738	olden (Australia) Commodore	Rear	P E
	olden (Australia) Statesman	Rear	P E
80-2761Sport	Audi A3	Rear	P E
	Seat Leon	Rear	P E
	Seat Toledo	Rear	P E
	Skoda Octavia	Rear	P E
	Volkswagen Bora	Rear	P E
	Volkswagen Golf 4	Rear	P E
	Volkswagen Jetta ( S markets only)	Rear	P E
	Volkswagen Lavida	Rear	P E
▲80-2761	Audi A3	Rear	P E
	Seat Leon	Rear	P E
	Skoda Octavia	Rear	P E
	Volkswagen Bora	Rear	P E
	Volkswagen Golf 4	Rear	P E
80-2762Sport	Audi A6	Rear	P E
	Audi 100	Rear	P E
	Audi 200	Rear	P E
80-2764	Mercedes-Ben V-Class (W638) (W639) (W447)	Rear	E E
80-2792SP1	olden (Australia) Commodore	Rear	P E
80-2796Sport	olden (Australia) Astra	Rear	E E
	Opel Astra	Rear	E E
	Vauxhall (See also Opel) Astra	Rear	E E
80-2805Sport	Audi TT	Rear	P E
80-2806Sport	Audi A3	Rear	E E
	Audi S3	Rear	E E
	Seat Leon	Rear	E E
	Volkswagen Bora	Rear	E E
	Volkswagen Golf 4	Rear	E E
80-2815Sport	Seat Toledo	Rear	P E
	Skoda Octavia	Rear	P E
	Skoda Rapid	Rear	P E
	Skoda Roomster	Rear	P E
	Volkswagen Bora	Rear	P E
	Volkswagen Golf 4	Rear	P E
	Volkswagen Polo	Rear	P E
	Volkswagen Vento	Rear	P E
80-2816	Ford Australia Falcon Fairmont A -series	Rear	E E
	Ford Australia Falcon Fairmont FG - series	Rear	E E
	Ford Australia Falcon BA-BF,Wagon,Series 2,3	Rear	E E
80-2818Sport	Audi TT	Rear	E E
80-2827Sport	Scion Scion	Rear	P E
	Toyota aris Echo Vit	Rear	P E
80-2830Sport	Audi A1	Rear	P E
	Audi A2	Rear	P E
	Seat Cordoba	Rear	P E
	Seat Ibi a	Rear	P E
	Skoda Fabia	Rear	P E
	Volkswagen Fox	Rear	P E
	Volkswagen Polo	Rear	P E
80-2838Sport	Nissan Almera	Rear	P E
	Nissan Sunny	Rear	P E
80-2859Sport	Audi A3	Rear	P E
	Seat Altea	Rear	P E
	Seat Leon	Rear	P E
	Seat Toledo	Rear	P E
	Skoda Octavia	Rear	P E
	Volkswagen Golf 5	Rear	P E
	Volkswagen Golf 6	Rear	P E

pe	Ma e Model	A le	🔑
	Volkswagen Jetta ( S markets only)	Rear	P E
	Volkswagen Jetta 5	Rear	P E
	Volkswagen Jetta 6	Rear	P E
	Volkswagen New Beetle	Rear	P E
	Volkswagen Sagitar	Rear	P E
	Volkswagen Scirocco	Rear	P E
▲80-2865Sport	Scion Scion	Rear	P E
	Toyota Avensis	Rear	P E
80-2879	Volkswagen Caddy	Rear	E E
	Volkswagen Commercial	Rear	E E
80-2902	Ssang ong Rexton	Rear	P E
▲80-2907	Nissan Qashqai	Rear	E E
	Nissan -Trail	Rear	E E
<b>8010-SERIES</b>			
8010-1032Sport	olden (Australia) Astra	Rear	P E
	Opel Astra	Rear	P E
	Vauxhall (See also Opel) Astra	Rear	P E
8010-1048Sport	Renault Clio	Rear	P E
8010-1050Sport	Acura RS	Rear	P E
	onda Civic	Rear	P E
8010-1053Sport	Subaru Legacy	Rear	P E
8010-1055Sport	Subaru Impre a	Rear	P E
<b>8040-SERIES</b>			
8040-1017	Chevrolet Camaro	Front	P E
	Pontiac Firebird	Front	P E
8040-1018	Chevrolet Camaro	Rear	E P
	Pontiac Firebird	Rear	E P
8040-1019	Chevrolet Corvette	Front	P E
8040-1020	Chevrolet Corvette	Rear	E E
8040-1026	Ford America Fairmont	Rear	P E
	Ford America Mustang	Rear	P E
	Mercury Capri	Rear	P E
	Mercury Cougar	Rear	P E
	Mercury Marquis	Rear	P E
8040-1035Sport	Porsche 924	Rear	E E
	Porsche 944	Rear	E E
	Porsche 968	Rear	E E
	Saab 9000	Rear	P E
8040-1057Sport	Toyota Supra	Front	P E
8040-1063Sport	Toyota Supra	Rear	P E
8040-1064Sport	Nissan Silvia	Rear	P E
8040-1081Sport	Porsche 911 (912)	Rear	P E
8040-1083	Buick Century	Front	P E
8040-1087	Buick Electra	Front	P E
	Buick Estate	Front	P E
	Buick Le Sabre	Front	P E
	Buick Riviera	Front	P E
	Buick Roadmaster	Front	P E
	Buick Skylark	Front	P E
	Cadillac Calais	Front	P E
	Chevrolet Bel Air	Front	P E
	Chevrolet Caprice	Front	P E
	Chevrolet Chevelle	Front	P E
	Chevrolet Chevy II	Front	P E
	Chevrolet El Camino	Front	P E
	Chevrolet Impala	Front	P E
	Oldsmobile Custom	Front	P E
	Oldsmobile F 85	Front	P E
	Oldsmobile 88	Front	P E
	Pontiac Bonneville	Front	P E
	Pontiac Can-Am	Front	P E
	Pontiac Grand Prix	Front	P E
	Pontiac Le Mans	Front	P E
	Pontiac Parisienne	Front	P E
	Pontiac Ventura	Front	P E
8040-1088	Buick Century	Rear	E E
	Buick Electra	Rear	E E
	Buick Estate	Rear	E E
	Buick Le Sabre	Rear	E E
	Buick Riviera	Rear	E E
	Buick Roadmaster	Rear	E E
	Buick Skylark	Rear	E E
	Cadillac Calais	Rear	E E
	Chevrolet Caprice	Rear	E E
	Chevrolet Chevelle	Rear	E E
	Chevrolet Chevy II	Rear	E E
	Chevrolet El Camino	Rear	E E
	Chevrolet Impala	Rear	E E
	Oldsmobile Custom	Rear	E E
	Oldsmobile F 85	Rear	E E
	Oldsmobile 88	Rear	E E
	Pontiac Bonneville	Rear	E E
	Pontiac Can-Am	Rear	E E
	Pontiac Grand Prix	Rear	E E
	Pontiac Le Mans	Rear	E E
	Pontiac Parisienne	Rear	E E
	Pontiac Ventura	Rear	E E
	Su uki Vitara	Rear	P E
8040-1106Sport	Nissan -Series	Rear	P E
8040-1119Sport	BMW -Series	Rear	P E
8040-1217Sport	BMW -Series	Rear	P E
▲8040-1226Sport	Nissan Silvia	Rear	P E
8040-1227Sport	Audi A6	Rear	P E
	Skoda Superb	Rear	P E
	Volkswagen Passat	Rear	P E



pe	Ma e Model	A le	🔑
8041-1338Sport	Nissan Australia Skyline	Front	P E
8041-1339Sport	Nissan Australia Skyline	Rear	
▲ 8041-1355Sport	Nissan Micra	Rear	P E
	Renault Clio	Rear	P E
	Renault Modus	Rear	P E
8041-1360Sport	onda Civic	Rear	P E
8041-1361Sport	onda Civic	Rear	P E
8041-1389Sport	Renault Clio	Rear	P E
8041-1401Sport	Ma da 6 (Aten a)	Front	
8041-1406LSport	Acura TS	Front	
	onda Accord	Front	
8041-1406RSport	Acura TS	Front	
	onda Accord	Front	
8041-1407Sport	Acura TS	Rear	
	onda Accord	Rear	
8041-1409Sport	Ford Europe Focus	Rear	P E
8041-1416Sport	Scion FR-S	Rear	P E
	Subaru BR	Rear	P E
	Toyota GT86	Rear	P E
	Toyota 86	Rear	P E
8041-1418Sport	Seat Mii	Rear	E E
	Skoda Citigo	Rear	E E
	Volkswagen p	Rear	E E
8041-1426Sport	Su uki Swift	Rear	
<b>8042-SERIES</b>			
8042-1134Sport	Ford America Mustang	Rear	P E
<b>8045-SERIES</b>			
8045-1021	Alfa Romeo GT	Front	
	Alfa Romeo 147	Front	
	Alfa Romeo 156	Front	
8045-1068	Ford Australia Focus	Rear	
	Ford Europe Focus	Rear	
	Ma da 3 (Axela)	Rear	
	Volvo C30	Rear	
8045-1070	Audi A1	Rear	
	Audi A2	Rear	
	Seat Cordoba	Rear	
	Seat Ibi a	Rear	
	Skoda Fabia	Rear	
	Volkswagen Fox	Rear	
	Volkswagen Polo	Rear	
8045-1083	Audi A3	Rear	
	Seat Leon	Rear	
	Seat Toledo	Rear	
	Skoda Octavia	Rear	
	Volkswagen Bora	Rear	
	Volkswagen Golf 4	Rear	
	Volkswagen Jetta ( S markets only)	Rear	
	Volkswagen Lavida	Rear	
8045-1084	Audi A3	Rear	
	Seat Altea	Rear	
	Seat Leon	Rear	
	Seat Toledo	Rear	
	Skoda Octavia	Rear	
	Volkswagen Golf 5	Rear	
	Volkswagen Golf 6	Rear	
	Volkswagen Jetta 5	Rear	
8045-1085	Seat Alhambra	Rear	
	Skoda Superb	Rear	
	Volkswagen Golf 5	Rear	
	Volkswagen Golf 6	Rear	
	Volkswagen Jetta ( S markets only)	Rear	
	Volkswagen Jetta 6	Rear	
	Volkswagen Magolan	Rear	
	Volkswagen Passat	Rear	
	Volkswagen Sharan	Rear	
	Volkswagen Touran	Rear	
8045-1096	Ford Australia Focus	Rear	
	Ford Europe Focus	Rear	
	Ma da 3 (Axela)	Rear	
	Volvo S40 V40	Rear	
	Volvo V50	Rear	
8045-1097	Ma da 3 (Axela)	Rear	
	Ma da 5 (Premacy)	Rear	
8045-1160	olden (Australia) Vectra	Rear	
	Opel Vectra	Rear	
	Saab 9-5	Rear	
	Saturn LS LW	Rear	
	Vauxhall (See also Opel) Vectra	Rear	
8045-1222	Audi A4	Rear	
	Audi A5	Rear	
	Audi A6	Rear	
	Audi A7	Rear	
8045-1226	Audi A3	Rear	
	Seat Leon	Rear	
	Skoda Octavia	Rear	
	Volkswagen Golf 5	Rear	
	Volkswagen Golf 6	Rear	
	Volkswagen Jetta 6	Rear	
	Volkswagen New Beetle	Rear	
	Volkswagen Scirocco	Rear	
8045-1228	Audi Q3	Rear	
	Volkswagen Tiguan	Rear	
8045-1232	Mini New Mini	Rear	

pe	Ma e Model	A le	🔑
8045-1246	Audi A4	Rear	
	Seat Exeo	Rear	
8045-1248	Abarth 500	Rear	
	Fiat 500	Rear	
	Ford Europe Ka	Rear	
8045-1265	Audi A4	Rear	
	Audi A5	Rear	
	Audi A6	Rear	
	Audi A7	Rear	
	Audi S4	Rear	
	Audi S5	Rear	
8045-1296	Mercedes-Ben C-Class (W204)	Rear	
8045-1335	Nissan Qashqai	Rear	
	Nissan -Trail	Rear	
	Renault Kadjar	Rear	
8045-1347	Ma da C -5	Rear	
8045-1377	onda CR-V	Rear	
8045-1378	Mercedes-Ben E-Class (W212)	Rear	
8045-1379	Mercedes-Ben C-Class (W205)	Front	
8045-1380	Mercedes-Ben C-Class (W205)	Rear	
<b>8050-SERIES</b>			
8050-1001	Audi A3	Rear	P E
	Seat Leon	Rear	P E
	Seat Toledo	Rear	P E
	Skoda Octavia	Rear	P E
	Volkswagen Bora	Rear	P E
	Volkswagen Golf 4	Rear	P E
	Volkswagen Jetta ( S markets only)	Rear	P E
	Volkswagen Lavida	Rear	P E
8050-1002	Seat Arosa	Rear	P E
	Volkswagen Lupo	Rear	P E
8050-1003	Seat Cordoba	Rear	P E
	Seat Ibi a	Rear	P E
	Volkswagen Polo	Rear	P E
8050-1004	Volkswagen New Beetle	Rear	P E
8050-1005	Audi A1	Rear	P E
	Audi A2	Rear	P E
	Seat Cordoba	Rear	P E
	Seat Ibi a	Rear	P E
	Skoda Fabia	Rear	P E
	Volkswagen Fox	Rear	P E
	Volkswagen Polo	Rear	P E
8050-1006	Audi A3	Rear	P E
	Seat Altea	Rear	P E
	Seat Leon	Rear	P E
	Seat Toledo	Rear	P E
	Skoda Octavia	Rear	P E
	Volkswagen Golf 5	Rear	P E
	Volkswagen Golf 6	Rear	P E
	Volkswagen Jetta ( S markets only)	Rear	P E
	Volkswagen Jetta 5	Rear	P E
	Volkswagen Jetta 6	Rear	P E
	Volkswagen Sagitar	Rear	P E
	Volkswagen Scirocco	Rear	P E
8050-1007	Seat Toledo	Rear	P E
	Volkswagen Golf 2	Rear	P E
	Volkswagen Golf 3	Rear	P E
	Volkswagen Jetta ( S markets only)	Rear	P E
	Volkswagen Jetta 2	Rear	P E
	Volkswagen Vento	Rear	P E
8050-1008	Seat Toledo	Rear	P E
	Volkswagen Golf 2	Rear	P E
	Volkswagen Golf 3	Rear	P E
	Volkswagen Jetta 2	Rear	P E
	Volkswagen Vento	Rear	P E
8050-1009	Audi A6	Rear	P E
	Skoda Superb	Rear	P E
	Volkswagen Passat	Rear	P E
8050-1010	Volkswagen Golf 1	Rear	P E
	Volkswagen Jetta 1	Rear	P E
	Volkswagen Scirocco	Rear	P E
8050-1011	Acura Integra	Front	
	onda Civic	Front	
8050-1012	onda Integra	Front	
	Acura Integra	Rear	E B
	onda Civic	Rear	E B
	onda Integra	Rear	E B
	onda Civic	Rear	E B
8050-1016	Seat Toledo	Rear	P E
8050-1017	Skoda Octavia	Rear	P E
	Skoda Rapid	Rear	P E
	Skoda Roomster	Rear	P E
	Volkswagen Bora	Rear	P E
	Volkswagen Golf 4	Rear	P E
	Volkswagen Polo	Rear	P E
	Volkswagen Vento	Rear	P E
8050-1019	Alfa Romeo GT	Front	
	Alfa Romeo 147	Front	
	Alfa Romeo 156	Front	
8050-1020	Citroen A	Rear	E E
	Citroen Saxo	Rear	E E
	Peugeot 106	Rear	E E
8050-1021	Citroen C2	Rear	
	Citroen C3	Rear	
8050-1022	Peugeot 205	Rear	E E

pe	Ma e Model	A le	🔑
8050-1023	Peugeot 309	Rear	E E
	Peugeot 206	Rear	E E
	Peugeot 206+	Rear	E E
8050-1027	Opel Corsa	Rear	P E
	Opel Tigra	Rear	P E
	Vauxhall (See also Opel) Corsa	Rear	P E
	Vauxhall (See also Opel) Tigra	Rear	P E
8050-1030	Daewoo (Chevrolet) Espero	Rear	P E
	Daewoo (Chevrolet) Lanos	Rear	P E
	Daewoo (Chevrolet) Nexia	Rear	P E
	Opel Astra	Rear	P E
	Vauxhall (See also Opel) Astra	Rear	P E
8050-1032	Ford Europe Focus	Rear	P E
8050-1039	Renault M gane	Rear	E E
8050-1040	Renault Clio	Rear	P E
8050-1041	Ma da M -5	Front	P E
8050-1042	Ma da M -5	Rear	P E
8050-1043	Ma da M -5	Front	P E
8050-1044	Ma da M -5	Rear	P E
8050-1048	Opel Astra	Rear	E E
	Vauxhall (See also Opel) Astra	Rear	E E
8050-1051	BMW 3-Series E46	Rear	P E
8050-1053	Scion Scion	Rear	
	Toyota aris Echo Vit	Rear	
8050-1054	olden (Australia) Barina	Rear	
	Opel Corsa	Rear	
	Opel Tigra	Rear	
	Vauxhall (See also Opel) Corsa	Rear	
	Vauxhall (See also Opel) Tigra	Rear	
8050-1055	Audi A4	Rear	
	Seat Exeo	Rear	
8050-1057	Renault M gane	Rear	
8050-1060	Mercedes-Ben E-Class (W124) (C124)	Rear	
	Mercedes-Ben 190-series (W201)	Rear	
8050-1063	Citroen sara	Rear	
	Citroen	Rear	
	Peugeot 306	Rear	
8050-1064	Mercedes-Ben C-Class (W202)	Front	
	Mercedes-Ben CLK-Class (W208)	Front	
8050-1065	Mercedes-Ben C-Class (W202)	Rear	
	Mercedes-Ben CLK-Class (W208)	Rear	
8050-1066	Mercedes-Ben E-Class (W210)	Front	
8050-1067	Mercedes-Ben E-Class (W210)	Rear	
8050-1068	Alfa Romeo GTV	Rear	
8050-1071	Audi 80	Rear	
8050-1077	Audi S6	Rear	
	Audi V8	Rear	
	Audi 100	Rear	
	Audi 200	Rear	
8050-1080	Volvo C70	Rear	
	Volvo S70 V70	Rear	
	Volvo 850	Rear	
▲8050-1083	Lada Samara	Rear	
8050-1084	Opel Astra	Rear	
	Opel afira	Rear	
	Vauxhall (See also Opel) Astra	Rear	
	Vauxhall (See also Opel) afira	Rear	
8050-1086	Audi A3	Rear	
	Audi S3	Rear	
	Seat Leon	Rear	
	Volkswagen Bora	Rear	
	Volkswagen Golf 4	Rear	
8050-1098	Fiat Punto	Rear	
8050-1099	Volvo S60 V60	Rear	
	Volvo S70 V70	Rear	
	Volvo S80	Rear	
8050-1100	Mini New Mini	Rear	
8050-1103	Ford Europe Fiesta	Rear	
	Ma da 2 (Demio)	Rear	
8050-1104	Opel Signum	Rear	
	Opel Vectra	Rear	
8050-1105	Cadillac BLS	Rear	
	Saab 9-3	Rear	
8050-1106	Fiat Panda	Rear	
8050-1107	Ma da 3 (Axela)	Rear	
8050-1108	Ford Australia Focus	Rear	
	Ford Europe Focus	Rear	
	Ma da 3 (Axela)	Rear	
	Volvo C30	Rear	
8050-1109	Ford Australia Focus	Rear	
	Ford Europe Focus	Rear	
	Ma da 3 (Axela)	Rear	
	Volvo S40 V40	Rear	
	Volvo V50	Rear	
8050-1110	Citroen C1	Rear	
	Peugeot 107	Rear	
	Peugeot 108	Rear	
	Toyota Aygo	Rear	
8050-1111	Fiat Grande Punto	Rear	
	Opel Corsa	Rear	
8050-1113	Alfa Romeo MiTo	Rear	
	Fiat Grande Punto	Rear	
	Opel Corsa	Rear	
8050-1115	Lexus IS	Front	
8050-1116	Lexus IS	Rear	
8050-1117L	onda S2000	Front	

pe	Ma e Model	A le	🔑
8050-1117R	onda S2000	Front	
8050-1118	onda S2000	Rear	
8050-1119	yundai Sonata	Front	
	Kia Magentis	Front	
	Kia Optima	Front	
8050-1120	yundai Sonata	Rear	
	Kia Magentis	Rear	
	Kia Optima	Rear	
8050-1122	Mercedes-Ben C-Class (W203)	Rear	
	Mercedes-Ben CLC-Class (CL203)	Rear	
	Mercedes-Ben CLK-Class (W209)	Rear	
8050-1123	Nissan Micra	Rear	
	Nissan Note	Rear	
	Renault Clio	Rear	
	Renault Modus	Rear	
8050-1125	Opel Agila	Rear	
	Su uki Splash	Rear	
	Su uki Swift	Rear	
	Vauxhall (See also Opel) Agila	Rear	
8050-1128	Audi TT	Rear	P E
8050-1139	Renault Clio	Rear	
8050-1140	Ma da 3 (Axela)	Rear	
	Ma da 5 (Premacy)	Rear	
8050-1141	Audi A4	Rear	P E
	Audi A5	Rear	P E
	Audi A6	Rear	P E
	Audi A7	Rear	P E
8050-1142	Audi A4	Rear	P E
	Audi A5	Rear	P E
	Audi A6	Rear	P E
	Audi A7	Rear	P E
8050-1143	Mercedes-Ben C-Class (W204)	Rear	
8050-1144	Kia Rio III	Rear	
8050-1145	Mercedes-Ben A-Class (W176), B-Class (W246)	Rear	P E
	Mercedes-Ben CLA-Class (C117)	Rear	P E
	Mercedes-Ben CLA-Class ( 117)	Rear	P E
8050-1146	Abarth 500	Rear	
	Fiat 500	Rear	
	Ford Europe Ka	Rear	
<b>82-SERIES</b>			
82-1019	Daimler Double six	Front	P E
	Daimler Six	Front	P E
	Daimler Sovereign	Front	P E
	Daimler 2.5	Front	P E
	Jaguar Mk	Front	P E
	Jaguar S	Front	P E
82-1027	Jaguar Mk	Front	E E
	Jaguar K	Front	E E
82-1044	Daimler 2.5	Rear	P P
	Jaguar Mk	Rear	P P
82-1081	Jaguar Mk	Rear	P E
	Jaguar K	Rear	P E
82-1107	Jaguar K	Front	E E
82-1216	Ferrari 508	Front	
	Ferrari 539	Front	
82-1232	Jaguar E-type	Front	E E
82-1255	Dodge Challenger	Rear	E E
	Dodge Charger	Rear	E E
	Plymouth Barracuda	Rear	E E
	Plymouth Belvedere	Rear	E E
	Plymouth Road Runner	Rear	E E
82-1388SP3	Ford America Mustang	Front	E B
	Mercury Cougar	Front	E B
82-1389	Ford America Mustang	Rear	P P
82-1518	Ford America Bronco	Front	P E
	Ford America Econoline	Front	P E
	Ford America F100	Front	P E
	Ford America F250	Front	P E
	Ford Australia F-series	Front	P E
82-1579SP2	Ferrari Dino	Front	E E
82-1603SP2	Ferrari Dino	Rear	E E
82-1668SPD1	Opel Ascona	Rear	P E
	Opel Kadett	Rear	P E
	Opel Manta	Rear	P E
82-1698	Ford Australia Falcon Fairmont -Series	Front	E B
	Ford Australia Galaxie	Front	E B
82-1739Sport	Opel Ascona	Front	P E
	Opel Manta	Front	P E
82-1740sport	Opel Kadett	Rear	
	Opel Manta	Rear	
82-1742SP4	Ford Australia Falcon Fairmont -Series	Front	E B
82-1756	Porsche 911 (912)	Rear	P E
82-1801Sport	Opel Ascona	Rear	P E
	Opel Commodore	Rear	P E
	Opel Manta	Rear	P E
	Opel Rekord	Rear	P E
	Vauxhall (See also Opel) Cavalier	Rear	P E
82-1825SP2	Ferrari 365	Rear	E E
	Ferrari 400	Rear	E E
82-1831SP1	Ferrari 308	Rear	E E
82-1833SP6	Ferrari 365	Front	E E
	Ferrari 512	Front	E E
82-1857SPF1	Simca 1000 Rallye II	Rear	P E
82-1886Sport	olden (Australia) Gemini	Front	P E
	olden (Australia) Pia a	Front	P E



pe	Ma e Model	A le	🔑
8240-1202SP	Jeep Liberty Jeep Wagoneer Jeep Cherokee Jeep Liberty Jeep Wagoneer	Front Front Rear Rear Rear	PE PE EE EE EE
8240-1203Sport 8240-1204Sport	BMW M3 Ssang ong Kyron Ssang ong Rexton	Rear Front Front	PE EE EE
8240-1205Sport	Citroen C4 Peugeot 307 Peugeot 308	Rear Rear Rear	PE PE PE
8240-1208Sport 8240-1219Sport 8240-1227Sport 8240-1229Sport 8240-1230Sport 8240-1231Sport	BMW -Series BMW 5-Series E6 Ma da R -8 Audi A6 Audi A6	Rear Rear Rear Front Rear	PE PE PE PE PE PE
▲ 8240-1233Sport 8240-1235Sport 8240-1236Sport 8240-1239Sport	BMW 1-Series E81 E82 E87 E88 BMW 5-Series E6 Audi S4 BMW 3-Series E90 91 92 93 Alfa Romeo Brera Alfa Romeo Spider Alfa Romeo 159	Rear Rear Front Rear Rear Rear Rear	PE PE PE EE PE PE PE
8240-1260Sport 8240-1261Sport	Renault M gane Audi A4 Audi A5 Audi A6 Audi A7	Rear Front Front Front Front	EE PE PE PE PE
8240-1262 8240-1263 8240-1264	Jeep Wrangler Jeep Wrangler Jeep Commander	Front Rear Front	PE PE PE
8240-1265	Jeep Grand Cherokee Jeep Commander	Front Rear	PE EE
8240-1268Sport	Jeep Grand Cherokee Ford Europe Mondeo Volvo S60 V60 Volvo S70 V70 Volvo S80	Rear Rear Rear Rear Rear	EE PE PE PE PE
8240-1270	Mitsubishi Challenger Mitsubishi L200 Mitsubishi Pajero Mitsubishi Triton	Front Front Front Front	PE PE PE PE
8240-1271SP1	Mitsubishi L200 Mitsubishi Triton	Rear Rear	PE PE
8240-1276Sport 8240-1279Sport	Ma da 6 (Aten a) Audi A4 Audi A5 Audi A6 Audi A7 Audi Q5 Audi S4 Audi S5	Rear Front Front Front Front Front Front	PE PE PE PE PE PE PE
8240-1280Sport 8240-1281	Ma da R -8 Ssang ong Actyon Ssang ong Rexton	Rear Front Front	PE PE PE
8240-1286	yundai i 35 yundai Tucson	Rear Rear	PE PE
8240-1287	Kia Sportage yundai i 35 yundai Tucson	Rear Rear Rear	PE PE PE
▲ 8240-1291Sport	Kia Sportage Buick Regal Opel Insignia	Rear Rear Rear	PE PE PE
8240-1293Sport	Vauxhall (See also Opel) Insignia Chevrolet Cru e Daewoo (Chevrolet) Lacetti Premiere olden (Australia) Cru e	Rear Rear Rear Rear	PE PE PE PE
8240-1294Sport	Opel Astra Vauxhall (See also Opel) Astra BMW 1-Series F20 F21 BMW 2-Series F22 BMW 3-Series F30 F31 F34 BMW 5-Series F	Rear Rear Rear Rear Rear Rear	PE PE PE PE PE PE
▲ 8240-1295Sport 8240-1296Sport	BMW 3-Series F30 F31 F34 BMW 5-Series F Audi A3 Seat Leon Skoda Octavia Volkswagen Golf 7	Rear Rear Rear Rear Rear Rear	PE PE PE PE PE PE
8240-1297Sport	Audi A3 Seat Leon Skoda Octavia Volkswagen Golf 7	Rear Rear Rear Rear	PE PE PE PE
8240-1298Sport	BMW 1-Series F20 F21 BMW 2-Series F22 BMW 3-Series F30 F31 F34 BMW 4-Series (F32 F33 F36)	Rear Rear Rear Rear	PE PE PE PE
▲ 8240-1299LSport ▲ 8240-1299RSport 8240-1300Sport	Alfa Romeo Giulietta Alfa Romeo Giulietta yundai I30 Kia Cee d	Rear Rear Rear Rear	PE PE PE PE
8240-1301Sport	Opel Aslra Opel Cascada Vauxhall (See also Opel) Astra	Rear Rear Rear	PE PE PE
8240-1302Sport 8240-1303Sport 8240-1304Sport	BMW -Series Mini New Mini BMW 1 BMW 2-Series F45 F46	Rear Rear Rear Rear	PE PE PE PE

pe	Ma e Model	A le	🔑
8240-1306Sport	Audi A3	Rear	
8240-1307sport 8240-1311Sport	Audi TT BMW 4-Series (F32 F33 F36) Seat Kodiaq Skoda Kodiaq Skoda Superb Volkswagen Passat Volkswagen Tiguan	Rear Rear Rear Rear Rear Rear	
8240-1316	Fiat Fullback Mitsubishi L200	Front Front	
8240-1318	Fiat Fullback Mitsubishi L200	Front Rear	
<b>8241-SERIES</b>			
8241-1050Sport 8241-1139Sport	Porsche 914 Chevrolet Camaro Pontiac Firebird	Rear Front Front	PE PE PE
8241-1140Sport	Chevrolet Camaro Pontiac Firebird	Rear Rear	PE PE
8241-1153Sport	Ford Australia Fairlane LTD Ford Australia Falcon Fairmont E-series Ford Australia Falcon Fairmont -Series Ford Australia Falcon Fairmont A -series	Front Front Front Front	EE EE EE EB
8241-1166Sport 8241-1216LSport	Infiniti G-series Nissan -Series	Front Front	
8241-1216RSport	Infiniti G-series Nissan -Series	Front Front	
8241-1217Sport	Infiniti G-series Nissan -Series	Rear Rear	
8241-1226Sport 8241-1238Sport	Ma da R -8 Alfa Romeo Brera Alfa Romeo Spider Alfa Romeo 159	Front Front Front Front	
8241-1240Sport 8241-1243Sport	Ford America Mustang Ma da M -5	Rear Front	PE
8241-1244Sport	Ma da M -5	Rear	
8241-1252LSport 8241-1252RSport	Mini New Mini Mini New Mini	Rear Rear	PE PE
8241-1272Sport 8241-1273LSport 8241-1273RSport 8241-1274Sport 8241-1282LSport	Porsche 911 (912) Porsche 911 (912) Porsche 911 (912) Porsche 911 (912) Infiniti G-series	Rear Rear Rear Rear Front	PE PE PE PE
8241-1282RSport	Nissan -Series Infiniti G-series Nissan -Series	Front Front Front	
8241-1283Sport	Infiniti G-series Nissan -Series	Rear Rear	
▲ 8241-1285Sport 8241-1289LSport 8241-1289RSport 8241-1290Sport 8241-1292Sport 8241-1293Sport	Lexus IS BMW 5-Series F BMW 5-Series F BMW 5-Series F Chevrolet Camaro Ford America Mustang Ford Europe Mustang	Rear Front Front Rear Rear Rear	PE PE PE PE PE PE
8241-1304Sport	Fiat 124 Ma da M -5	Front Front	
8241-1305Sport	Fiat 124 Ma da M -5	Rear Rear	
8241-1306Sport 8241-1307Sport	Chevrolet Corvette Chevrolet Corvette	Front Rear	
▲ 8241-1310Sport	Fiat 124 Ma da M -5	Front	
▲ 8241-1311Sport	Fiat 124 Ma da M -5	Front Rear	
<b>8242-SERIES</b>			
▲ 8242-1006SP1	Chevrolet Camaro Pontiac Firebird	Rear Rear	PE PE
<b>8245-SERIES</b>			
8245-1004 8245-1008	BMW 5-Series E6 Audi A4	Rear Front	
8245-1011	Seat Exeo Cadillac BLS Saab 9-3	Rear Rear Rear	
8245-1015	BMW 1-Series E81 E82 E87 E88 BMW 3-Series E90 91 92 93	Rear Rear	
8245-1017	Volvo C70 Volvo S70 V70 Volvo 850	Rear Rear Rear	
8245-1023 8245-1024 8245-1032	BMW 3-Series E46 BMW 3-Series E46 Audi A3 Audi S3 Seat Leon	Rear Rear Rear Rear Rear	
8245-1041 8245-1042L 8245-1042R 8245-1043 8245-1054 8245-1056 8245-1094 8245-1175	Volkswagen Bora Volkswagen Golf 4 BMW 5-Series E6 Kia Sorento Kia Sorento Kia Sorento BMW 5-Series E39 BMW 5-Series E39 BMW 3-Series E90 91 92 93 Su uki Vitara	Rear Rear Rear Front Front Rear Rear Rear Rear	



pe	Ma e Model	A le	
8245-1177	Toyota RAV4	Rear	
8245-1178	Kia Sorento	Rear	
8245-1190L	Mini New Mini	Rear	
8245-1190R	Mini New Mini	Rear	
8245-1195L	Kia Sorento	Front	
8245-1195R	Kia Sorento	Front	
8245-1221	Audi A4	Front	
	Audi A5	Front	
8245-1223	Jeep Commander	Front	
	Jeep Grand Cherokee	Front	
8245-1224	Jeep Commander	Rear	
	Jeep Grand Cherokee	Rear	
8245-1251	Porsche 911 (912)	Rear	
8245-1253L	Porsche 911 (912)	Rear	
8245-1253R	Porsche 911 (912)	Rear	
8245-1255	Porsche 911 (912)	Rear	
8245-1256	Ford Europe Mondeo	Rear	
	Volvo S60 V60	Rear	
	Volvo S70 V70	Rear	
	Volvo S80	Rear	
8245-1264	Audi A4	Front	
	Audi A5	Front	
	Audi A6	Front	
	Audi A7	Front	
	Audi Q5	Front	
	Audi S4	Front	
	Audi S5	Front	
8245-1294	Audi A6	Front	
	Audi A7	Front	
8245-1302L	BMW 5-Series F	Front	
8245-1302R	BMW 5-Series F	Front	
8245-1303	BMW 5-Series F	Rear	
8245-1308	Volvo C60	Rear	
8245-1310	BMW 3	Rear	
8245-1319	BMW 1-Series F20 F21	Rear	
	BMW 2-Series F22	Rear	
	BMW 3-Series F30 F31 F34	Rear	
	BMW 5-Series F	Rear	
8245-1320	Toyota Prius	Rear	
8245-1322	Audi A3	Rear	
8245-1326	Seat Leon	Rear	
	Skoda Octavia	Rear	
8245-1327	Volkswagen Golf 7	Rear	
	Audi A3	Rear	
	Seat Leon	Rear	
	Skoda Octavia	Rear	
	Volkswagen Golf 7	Rear	
8245-1343L	BMW 5	Rear	
	BMW 6	Rear	
8245-1343R	BMW 5	Rear	
	BMW 6	Rear	
8245-1357	BMW 1-Series F20 F21	Rear	
	BMW 2-Series F22	Rear	
	BMW 3-Series F30 F31 F34	Rear	
	BMW 4-Series (F32 F33 F36)	Rear	
8245-1359	yundai Santa Fe	Rear	
	Kia Sorento	Rear	
8245-1363	yundai Santa Fe	Rear	
	Kia Sorento	Rear	
8245-1376	Mini New Mini	Rear	
8245-1377	Volvo C70	Rear	
8245-1378	Nissan Qashqai	Rear	
	Renault Kadjar	Rear	
8245-1379	yundai Santa Fe	Rear	
	Kia Sorento	Rear	
8245-1380	BMW 1	Rear	
	BMW 2-Series F45 F46	Rear	
8245-1381	BMW 3	Rear	
	BMW 4	Rear	
8245-1383	Volvo C90	Rear	
8245-1385	BMW 4-Series (F32 F33 F36)	Rear	
8245-1387	Seat Kodiak	Rear	
	Skoda Kodiak	Rear	
	Skoda Superb	Rear	
	Volkswagen Passat	Rear	
	Volkswagen Tiguan	Rear	
8245-1395	Nissan Navara	Front	
<b>8250-SERIES</b>			
8250-1001	Audi A4	Front	E B
	Audi A6	Front	E B
	Skoda Superb	Front	E B
	Volkswagen Passat	Front	E B
8250-1002	BMW 3-Series E36	Rear	P E
8250-1003	Citroen C4	Rear	
	Peugeot 307	Rear	
8250-1004	Audi A6	Rear	
	Volkswagen Passat	Rear	
8250-1011	Audi A4	Front	
	Seat Exeo	Front	
8250-1012	Alfa Romeo 145 146	Rear	
	Fiat Bravo Brava	Rear	
	Fiat Multipla	Rear	
8250-1013	Opel Ascona	Rear	
	Opel Commodore	Rear	
	Opel Manta	Rear	

pe	Ma e Model	A le	
8250-1014	Opel Rekord	Rear	
	Vauxhall (See also Opel) Cavalier	Rear	
	Opel Ascona	Front	
	Opel Kadett	Front	
	Opel Manta	Front	
	Vauxhall (See also Opel) Cavalier	Front	
	Vauxhall (See also Opel) Chevette	Front	
8250-1018	Fiat Barchetta	Rear	
	Fiat Punto	Rear	
	Lancia psilon	Rear	
8250-1020	Peugeot 406	Rear	
8250-1021	BMW 5-Series E39	Rear	
8250-1022	Audi A6	Front	
8250-1023	Audi A6	Rear	
8250-1024	BMW 1-Series E81 E82 E87 E88	Rear	
8250-1025	Opel Astra	Rear	
	Vauxhall (See also Opel) Astra	Rear	
8250-1026	BMW 3-Series E90 91 92 93	Rear	
8250-1034	Ma da M -5	Front	
8250-1035	Ma da M -5	Rear	
8250-1039	Ford America Mustang	Rear	
	Ford Europe Mustang	Rear	
8250-1040	Ma da R -8	Front	
8250-1041	Ma da R -8	Rear	
8250-1042	Ma da R -8	Rear	
8250-1043	Ford Europe Mondeo	Rear	
8250-1044	Audi A3	Rear	P E
	Seat Leon	Rear	P E
	Skoda Octavia	Rear	P E
	Volkswagen Golf 7	Rear	P E
8250-1045	BMW 1-Series F20 F21	Rear	P E
	BMW 2-Series F22	Rear	P E
	BMW 3-Series F30 F31 F34	Rear	P E
8250-1047	Audi A4	Front	
	Audi A5	Front	
	Audi A6	Front	
	Audi A7	Front	
8250-1048	Audi A4	Front	P E
	Audi A5	Front	P E
	Audi A6	Front	P E
	Audi A7	Front	P E
8250-1050	Audi A3	Rear	P E
	Seat Leon	Rear	P E
	Skoda Octavia	Rear	P E
	Volkswagen Golf 7	Rear	P E
8250-1052L	Alfa Romeo Giulietta	Rear	
8250-1052R	Alfa Romeo Giulietta	Rear	
<b>86-SERIES</b>			
86-1308	Porsche 911 (912)	Front	
86-1394	Porsche 911 (912)	Front	
86-1519Sport	BMW 02-Series 114 E10 E20	Front	
86-1638	Porsche 911 (912)	Front	
86-1647	Porsche 911 (912)	Front	
86-1741	Volkswagen Beetle	Front	
86-1811	Nissan -Series	Front	
86-1812	Nissan -Series	Rear	
86-1835Sport	Ford Europe Capri	Front	
	Ford Europe Escort	Front	
86-1919Sport	Volkswagen Caddy	Front	
	Volkswagen Commercial	Front	
	Volkswagen Golf 1	Front	
	Volkswagen Jetta 1	Front	
	Volkswagen Scirocco	Front	
86-1919	Volkswagen Caddy	Front	
	Volkswagen Commercial	Front	
	Volkswagen Golf 1	Front	
	Volkswagen Jetta 1	Front	
	Volkswagen Scirocco	Front	
86-1922Sport	Audi 50	Front	
	Volkswagen Derby	Front	
	Volkswagen Polo	Front	
86-1942	Porsche 911 (912)	Front	
86-1943	Porsche 911 (912)	Front	
86-1980	Porsche 924	Front	
	Porsche 944	Front	
	Volkswagen Beetle	Front	
	Daihatsu Charmant	Front	
86-1991Sport	Toyota Carina Corona	Front	
	Toyota Celica	Front	
	Toyota Corolla	Front	
86-2066Sport	Audi Coup	Front	
	Audi 80	Front	
	Audi 90	Front	
	Volkswagen Passat	Front	
	Volkswagen Santana	Front	
86-2076SP1	olden (Australia) Commodore	Front	
	olden (Australia) Statesman	Front	
86-2086SPD2	Audi RS2	Front	
	Audi S2	Front	
86-2086Sport	Audi Coup	Rear	
	Audi Quattro	Front	
	Audi 80	Rear	
	Audi 90	Rear	
86-2087Sport	Audi Quattro	Rear	
86-2149Sport	Audi A6	Front	

pe	Ma e Model	A le	
▲86-2149	Audi S4 Audi S6 Audi V8 Audi 100 Audi 200 Audi A6 Audi 100 Audi 200	Front Front Front Front Front Front Front Front	
86-2224	Nissan Australia Skyline Nissan Australia 160 - 180 - 200	Front Front	
86-2277Sport	BMW -Series BMW 3-Series E30	Front Front	
86-2277SP1	BMW M3	Front	
86-2380	Lada Diva Lada Samara	Front Front	
86-2433Sport	Audi Coup Audi S2 Audi 90	Rear Rear Rear	
86-2448Sport	Alfa Romeo 33	Front	
86-2483Sport	Volkswagen Polo	Front	
86-2535	olden (Australia) Commodore olden (Australia) Crewman olden (Australia) Statesman	Front Front Front	
86-2568Sport	Citroen A Citroen Saxo Peugeot 106	Front Front Front	
86-2575	Mercedes-Ben V-Class (W638) (W639) (W447)	Front	
86-2588Sport	olden (Australia) Barina Su uki Swift	Front Front	
<b>8610-SERIES</b>			
8610-1262Sport	Audi Coup Audi 80 Audi 90	Front Front Front	
8610-1263Sport	olden (Australia) Calibra olden (Australia) Vectra Opel Calibra Opel Vectra	Front Front Front Front	
8610-1283Sport	Vauxhall (See also Opel) Calibra Vauxhall (See also Opel) Cavalier olden (Australia) Astra Opel Astra	Front Front Front Front	
8610-1315Sport	Vauxhall (See also Opel) Astra Cadillac Catera Opel Omega	Front Front Front	
8610-1343Sport	Vauxhall (See also Opel) Omega Mitsubishi Colt Mitsubishi Lancer Proton Satria	Front Front Front Front	
8610-1351Sport	Subaru Impre a	Front	
8610-1352Sport	Subaru Impre a	Rear	
8610-1408Sport	Subaru Impre a	Rear	
8610-1409Sport	Nissan Almera	Front	
8610-1410Sport	Nissan Sunny yundai Coup yundai Lantra	Front Front Front	
8610-1415Sport	Acura RS onda Civic	Front Front	
8610-1421Sport	Toyota Camry	Front	
8610-1439Sport	olden (Australia) Commodore	Front	
8610-1440Sport	Subaru Impre a	Rear	
8610-1447Sport	Subaru Legacy	Front	
<b>8640-SERIES</b>			
8640-1428	Chrysler America Voyager Dodge Caravan Plymouth Voyager	Front Front Front	
▲8640-1459	Mitsubishi Pajero	Front	
<b>8641-SERIES</b>			
8641-1021Sport	BMW -Series BMW 3-Series E30	Front Front	
8641-1029Sport	BMW 3-Series E30	Front	
8641-1038Sport	Porsche 924 Porsche 944 Volkswagen Beetle	Front Front Front	
8641-1039Sport	Porsche 911 (912)	Front	
8641-1048Sport	Volkswagen Caddy Volkswagen Commercial Volkswagen Golf 1 Volkswagen Jetta 1 Volkswagen Scirocco	Front Front Front Front Front	
8641-1060Sport	Nissan -Series	Front	
8641-1066Sport	olden (Australia) Commodore olden (Australia) Statesman	Front Front	
8641-1068Sport	Opel Kadett Vauxhall (See also Opel) Astra	Front Front	
8641-1071Sport	Toyota MR2	Front	
8641-1072Sport	Toyota MR2	Rear	
8641-1077Sport	Porsche 914	Front	
8641-1114Sport	Saab 9000	Front	
8641-1142Sport	Toyota MR2	Rear	
8641-1144Sport	BMW 3-Series E30	Front	
8641-1157Sport	BMW 5-Series E34 BMW 7-Series E32	Front Front	
8641-1198Sport	Volkswagen Corrado	Front	

pe	Ma e Model	A le	
8641-1210Sport	Volkswagen Golf 2 Volkswagen Passat BMW M3 BMW 3-Series E30	Front Front Front Front	
8641-1220Sport	Toyota MR2	Front	
8641-1221Sport	Toyota MR2	Rear	
8641-1224Sport	BMW 5-Series E34 BMW 7-Series E32	Front Front	
8641-1231Sport	Chrysler America Eagle Talon Mitsubishi Eclipse Plymouth Laser	Front Front Front	
8641-1245Sport	Volvo 240-, 260-series	Front	
8641-1246Sport	Volvo 740 Volvo 760 Volvo 940 Volvo 960	Front Front Front Front	
8641-1297Sport	olden (Australia) Commodore olden (Australia) Crewman olden (Australia) Statesman	Front Front Front	
8641-1319Sport	Pontiac GTO	Front	
8641-1320Sport	Toyota RAV4	Front	
8641-1329Sport	Fiat Coup Lada Diva Lada Samara	Front Front Front	
8641-1342Sport	BMW M3 BMW -Series	Front Front	
▲8641-1362Sport	Infiniti I-series Nissan Maxima	Front Front	
8641-1364Sport	Nissan Silvia	Front	
8641-1389Sport	Saab 9-3	Front	
8641-1409Sport	Toyota Celica	Front	
8641-1410Sport	Volvo S60 V60 Volvo S70 V70 Volvo S80	Front Front Front	
8641-1414Sport	Porsche 944 Porsche 968	Front Front	
8641-1416Sport	onda Civic	Front	
8641-1420Sport	Toyota MR2	Front	
8641-1422Sport	Toyota MR2	Rear	
8641-1427Sport	Toyota RAV4	Front	
▲8641-1439Sport	Infiniti I-series Nissan Maxima	Front Front	
▲8641-1451Sport	Nissan -Trail	Front	
▲8641-1452Sport	Nissan -Trail	Rear	
8641-1497Sport	onda Civic	Front	
8641-1498Sport	onda Civic	Front	
▲8641-1503	yundai Tucson	Front	
▲8641-1504	Kia Sportage yundai Tucson	Front Rear	
8641-1506Sport	Kia Sportage olden (Australia) Commodore olden (Australia) Crewman olden (Australia) Statesman	Rear Front Front Front	
▲8641-1510	Su uki Vitara	Front	
▲8641-1545Sport	Lada Kalina	Front	
8641-1550	yundai i 35 yundai Tucson	Front Front	
8641-1553Sport	Kia Sportage yundai Veloster	Front Front	
<b>8645-SERIES</b>			
8645-1151	yundai Tucson	Front	
8645-1152	Kia Sportage yundai Tucson	Front Rear	
8645-1174	Kia Sportage	Rear	
8645-1176	Su uki Vitara Toyota RAV4	Front Front	
<b>8650-SERIES</b>			
8650-1003	Citroen A Citroen Saxo Peugeot 106	Front Front Front	
8650-1004	Opel Astra Vauxhall (See also Opel) Astra	Front Front	
8650-1005	Volkswagen Caddy Volkswagen Commercial Volkswagen Golf 1 Volkswagen Jetta 1 Volkswagen Scirocco	Front Front Front Front Front	
8650-1006	Daewoo (Chevrolet) Espero Daewoo (Chevrolet) Lanos Daewoo (Chevrolet) Nexia	Front Front Front	
8650-1007	Opel Kadett Vauxhall (See also Opel) Astra	Front Front	
8650-1010	Audi A6 Audi S6 Audi V8 Audi 100 Audi 200	Front Front Front Front Front	
▲8650-1012	Audi Coup Audi 80 Audi 90 Lada Samara	Front Front Front Front	
<b>87-SERIES</b>			
87-2429Sport	olden (Australia) Barina	Rear	



pe	Ma e Model	A le	
8741-1476Sport 8741-1479LSport	Alfa Romeo 156 BMW 5-Series E6 Cadillac BLS Saab 9-3	Rear Front Front Front	
8741-1479RSport	Cadillac BLS Saab 9-3	Front Front	
8741-1481LSport 8741-1481RSport 8741-1484LSport	BMW 3-Series E46 BMW 3-Series E46 BMW 1-Series E81 E82 E87 E88 BMW 3-Series E90 91 92 93	Front Front Front Front	
8741-1484RSport	BMW 1-Series E81 E82 E87 E88 BMW 3-Series E90 91 92 93	Front Front	
8741-1487LSport	Ford Australia Focus Ford Europe Focus	Front Front	
8741-1487RSport	Ma da 3 (Axela) Ford Australia Focus Ford Europe Focus Ma da 3 (Axela)	Front Front Front Front	
8741-1488Sport	Audi Q3 Seat Alhambra Skoda Superb Volkswagen Golf 5 Volkswagen Golf 6 Volkswagen Magolan Volkswagen Passat Volkswagen Sharan Volkswagen Tiguan Volkswagen Touran	Front Front Front Front Front Front Front Front Front Front Front	
8741-1490LSport	Ford Australia Focus Ford Europe Focus Ma da 3 (Axela) Ma da 5 (Premacy) Volvo C30 Volvo C70 Volvo S40 V40 Volvo V50	Front Front Front Front Front Front Front Front	
8741-1490RSport	Ford Australia Focus Ford Europe Focus Ma da 3 (Axela) Ma da 5 (Premacy) Volvo C30 Volvo C70 Volvo S40 V40 Volvo V50	Front Front Front Front Front Front Front Front	
8741-1494Sport 8741-1512LSport 8741-1512RSport 8741-1515Sport	Ford America Mustang Mini New Mini Mini New Mini Audi S3 Audi TT	Front Front Front Front Front	
8741-1533Sport	Renault Clio	Front	
8741-1535LSport 8741-1535RSport	Renault M gane BMW 3-Series E90 91 92 93 BMW 3-Series E90 91 92 93	Front Front Front	
8741-1536LSport 8741-1536RSport 8741-1538LSport	Ford Europe Mondeo Ford Europe Mondeo Volvo S60 V60 Volvo S70 V70 Volvo S80	Front Front Front Front Front	
8741-1538RSport	Volvo S60 V60 Volvo S70 V70 Volvo S80	Front Front Front	
8741-1539Sport	Cadillac BLS Saab 9-3	Front Front	
8741-1541LSport 8741-1541RSport 8741-1542LSport 8741-1542RSport 8741-1543Sport 8741-1548Sport	Porsche 911 (912) Porsche 911 (912) Porsche 911 (912) Porsche 911 (912) Porsche 911 (912) Audi A1 Seat Ibi a Seat Toledo Skoda Fabia Skoda Rapid Volkswagen Polo Volkswagen Vento	Front Front Front Front Front Front Front Front Front Front Front Front Front Front	
8741-1549Sport 8741-1551LSport 8741-1551RSport 8741-1554Sport 8741-1555LSport	Ford America Mustang Ford Europe Focus Ford Europe Focus Mercedes-Ben C-Class (W204) Citroen DS3 Peugeot 208	Front Front Front Front Front Front	
8741-1555RSport	Citroen DS3 Peugeot 208	Front Front	
8741-1557LSport 8741-1557RSport 8741-1560LSport	Ford Europe Focus Ford Europe Focus Scion FR-S Subaru BR Toyota GT86 Toyota 86	Front Front Front Front Front Front	
8741-1560RSport	Scion FR-S Subaru BR Toyota GT86 Toyota 86	Front Front Front Front	
8741-1563LSpor 8741-1563RSpor 8741-1565LSport	Chevrolet Camaro Chevrolet Camaro Ford Europe Fiesta	Front Front Front	

pe	Ma e Model	A le	
8741-1565RSport 8741-1568LSport	Ford Europe Fiesta Chevrolet Cru e Daewoo (Chevrolet) Lacetti Premiere olden (Australia) Cru e	Front Front Front Front	
8741-1568RSport	Opel Astra Vauxhall (See also Opel) Astra Chevrolet Cru e Daewoo (Chevrolet) Lacetti Premiere olden (Australia) Cru e Opel Astra Vauxhall (See also Opel) Astra	Front Front Front Front Front Front Front Front	
8741-1569Sport	BMW 1-Series F20 F21 BMW 2-Series F22 BMW 3-Series F30 F31 F34	Front Front Front	
8741-1570Sport 8741-1571Sport	Mercedes-Ben E-Class (W212) Audi A3 Seat Leon Skoda Octavia Volkswagen Golf 7	Front Front Front Front Front	
8741-1572Sport	Audi A3 Seat Kodiao Seat Leon Skoda Kodiao Skoda Octavia Skoda Superb Volkswagen Golf 7 Volkswagen Passat Volkswagen Tiguan	Front Front Front Front Front Front Front Front Front	
8741-1573Sport 8741-1576LSport	Porsche Boxster Mercedes-Ben A-Class (W176), B-Class (W246) Mercedes-Ben CLA-Class (C117) Mercedes-Ben CLA-Class ( 117)	Front Front Front Front	
8741-1576RSport	Mercedes-Ben A-Class (W176), B-Class (W246) Mercedes-Ben CLA-Class (C117) Mercedes-Ben CLA-Class ( 117)	Front Front Front	
8741-1577LSport 8741-1577RSport 8741-1578LSport 8741-1578RSport 8741-1579LSport 8741-1579RSport 8741-1580LSport 8741-1580RSport 8741-1581LSport 8741-1581RSport 8741-1582Sport	Ma da 3 (Axela) Ma da 3 (Axela) Ma da 6 (Aten a) Ma da 6 (Aten a) Ma da C -5 Ma da C -5 Volvo S40 V40 Volvo S40 V40 Su uki Swift Su uki Swift BMW 1-Series F20 F21 BMW 2-Series F22 BMW 3-Series F30 F31 F34 BMW 4-Series (F32 F33 F36)	Front Front	
▲ 8741-1583LSport ▲ 8741-1583RSport 8741-1584LSport	Alfa Romeo Giulietta Alfa Romeo Giulietta yundai I30	Front Front Front	
8741-1584RSport	Kia Cee d yundai I30	Front Front	
8741-1585LSport	Kia Cee d Opel Astra Opel Cascada Vauxhall (See also Opel) Astra	Front Front Front Front	
8741-1585RSport	Opel Astra Opel Cascada Vauxhall (See also Opel) Astra	Front Front Front	
8741-1587LSport 8741-1587RSport 8741-1589Sport	BMW -Series BMW -Series Ford America Mustang Ford Europe Mustang	Front Front Front Front	
8741-1590LSport 8741-1590RSport 8741-1591LSport	Mini New Mini Mini New Mini BMW 1-Series F20 F21 BMW 2-Series F22 BMW 3-Series F30 F31 F34	Front Front Front Front Front	
8741-1591RSport	BMW 1-Series F20 F21 BMW 2-Series F22 BMW 3-Series F30 F31 F34	Front Front Front	
8741-1592LSport	BMW 1 BMW 2-Series F45 F46 BMW 1	Front Front Front	
8741-1592RSport	BMW 1 BMW 2-Series F45 F46	Front Front	
8741-1593LSport 8741-1593RSport 8741-1596Sport	Mitsubishi Lancer Mitsubishi Lancer Audi TT	Front Front Front	
<b>8745-SERIES</b>			
8745-1003 8745-1006	BMW 5-Series E6 Audi A3 Seat Altea Seat Leon Skoda Octavia Volkswagen Golf 5 Volkswagen Golf 6 Volkswagen New Beetle	Front Front Front Front Front Front Front Front	
8745-1010L	Cadillac BLS Saab 9-3	Front Front	
8745-1010R	Cadillac BLS Saab 9-3	Front Front	
8745-1012L 8745-1012R	Mini New Mini Mini New Mini	Front Front	

pe	Ma e Model	A le	
8745-1014L	BMW 1-Series E81 E82 E87 E88	Front	
8745-1014R	BMW 3-Series E90 91 92 93	Front	
8745-1016	BMW 1-Series E81 E82 E87 E88	Front	
	BMW 3-Series E90 91 92 93	Front	
	Volvo C70	Front	
	Volvo S70 V70	Front	
	Volvo 850	Front	
8745-1020	Alfa Romeo GT	Rear	
	Alfa Romeo 147	Rear	
	Alfa Romeo 156	Rear	
8745-1022L	BMW 3-Series E46	Front	
8745-1022R	BMW 3-Series E46	Front	
8745-1029	Audi A3	Front	
	Seat Leon	Front	
	Seat Toledo	Front	
	Skoda Octavia	Front	
	Volkswagen Bora	Front	
	Volkswagen Golf 4	Front	
	Volkswagen Jetta ( S markets only)	Front	
	Volkswagen Lavida	Front	
8745-1030	Audi A3	Front	
	Audi S3	Front	
	Seat Leon	Front	
	Skoda Octavia	Front	
	Volkswagen Bora	Front	
	Volkswagen Golf 4	Front	
8745-1038	Seat Toledo	Front	
	Skoda Octavia	Front	
	Skoda Superb	Front	
	Skoda etii	Front	
	Volkswagen Commercials	Front	
	Volkswagen Eos	Front	
	Volkswagen Golf 5	Front	
	Volkswagen Golf 6	Front	
	Volkswagen Jetta ( S markets only)	Front	
	Volkswagen Jetta 5	Front	
	Volkswagen Jetta 6	Front	
	Volkswagen Touran	Front	
8745-1053	BMW 5-Series E39	Front	
8745-1069	Audi A2	Front	
	Seat Cordoba	Front	
	Seat Ibi a	Front	
	Skoda Fabia	Front	
	Volkswagen Fox	Front	
	Volkswagen Polo	Front	
8745-1081	Seat Alhambra	Front	
	Volkswagen Magotan	Front	
	Volkswagen Passat	Front	
	Volkswagen Sharan	Front	
8745-1110L	Ford Australia Focus	Front	
	Ford Europe Focus	Front	
	Ma da 3 (Axela)	Front	
	Ma da 5 (Premacy)	Front	
	Volvo C30	Front	
	Volvo S40 V40	Front	
	Volvo V50	Front	
8745-1110R	Ford Australia Focus	Front	
	Ford Europe Focus	Front	
	Ma da 3 (Axela)	Front	
	Ma da 5 (Premacy)	Front	
	Volvo C30	Front	
	Volvo S40 V40	Front	
	Volvo V50	Front	
8745-1159	Saab 9-5	Front	
8745-1189L	Mini New Mini	Front	
8745-1189R	Mini New Mini	Front	
8745-1225	Audi A3	Front	
	Seat Leon	Front	
	Skoda Octavia	Front	
	Volkswagen Golf 5	Front	
	Volkswagen Golf 6	Front	
	Volkswagen New Beetle	Front	
	Volkswagen Scirocco	Front	
8745-1234L	BMW 3-Series E90 91 92 93	Front	
8745-1234R	BMW 3-Series E90 91 92 93	Front	
8745-1241L	Volvo S60 V60	Front	
	Volvo S70 V70	Front	
	Volvo S80	Front	
	Volvo C70	Front	
8745-1241R	Volvo S60 V60	Front	
	Volvo S70 V70	Front	
	Volvo S80	Front	
8745-1247L	Volvo C70	Front	
	Abarth 500	Front	
	Fiat 500	Front	
	Ford Europe Ka	Front	
8745-1247R	Abarth 500	Front	
	Fiat 500	Front	
	Ford Europe Ka	Front	
8745-1250L	Porsche 911 (912)	Front	
8745-1250R	Porsche 911 (912)	Front	
8745-1252L	Porsche 911 (912)	Front	
8745-1252R	Porsche 911 (912)	Front	
8745-1254	Porsche 911 (912)	Front	
8745-1263	Audi Q3	Front	
	Volkswagen Tiguan	Front	

pe	Ma e Model	A le	
8745-1278	Audi A1	Front	
	Seat Ibi a	Front	
	Seat Toledo	Front	
	Skoda Fabia	Front	
	Skoda Rapid	Front	
	Volkswagen Polo	Front	
	Volkswagen Vento	Front	
8745-1295	Mercedes-Ben C-Class (W204)	Front	
8745-1309L	BMW 3	Front	
8745-1309R	BMW 3	Front	
8745-1313L	Volvo C60	Front	
8745-1313R	Volvo C60	Front	
8745-1318	BMW 1-Series F20 F21	Front	
	BMW 2-Series F22	Front	
	BMW 3-Series F30 F31 F34	Front	
8745-1321L	Toyota Prius	Front	
8745-1321R	Toyota Prius	Front	
8745-1323	Mercedes-Ben E-Class (W212)	Front	
8745-1324	Audi A3	Front	
	Seat Leon	Front	
	Skoda Octavia	Front	
	Volkswagen Golf 7	Front	
8745-1325	Audi A3	Front	
	Seat Leon	Front	
	Skoda Octavia	Front	
	Volkswagen Golf 7	Front	
8745-1328	Porsche Boxster	Front	
8745-1329	Porsche Boxster	Rear	
8745-1334L	Nissan Qashqai	Front	
	Nissan -Trail	Front	
8745-1334R	Nissan Qashqai	Front	
	Nissan -Trail	Front	
8745-1342	BMW 5	Front	
	BMW 6	Front	
8745-1346L	Ma da C -5	Front	
8745-1346R	Ma da C -5	Front	
8745-1356	BMW 1-Series F20 F21	Front	
	BMW 2-Series F22	Front	
	BMW 3-Series F30 F31 F34	Front	
	BMW 4-Series (F32 F33 F36)	Front	
	yundai Santa Fe	Front	
8745-1358L	Kia Sorento	Front	
8745-1358R	yundai Santa Fe	Front	
	Kia Sorento	Front	
8745-1362L	yundai Santa Fe	Front	
	Kia Sorento	Front	
8745-1362R	yundai Santa Fe	Front	
	Kia Sorento	Front	
8745-1376L	onda CR-V	Front	
8745-1376R	onda CR-V	Front	
8745-1377L	Mini New Mini	Front	
8745-1377R	Mini New Mini	Front	
8745-1378L	BMW 1-Series F20 F21	Front	
	BMW 2-Series F22	Front	
	BMW 3-Series F30 F31 F34	Front	
8745-1378R	BMW 1-Series F20 F21	Front	
	BMW 2-Series F22	Front	
	BMW 3-Series F30 F31 F34	Front	
8745-1379L	Nissan Qashqai	Front	
	Renault Kadjar	Front	
8745-1379R	Nissan Qashqai	Front	
	Renault Kadjar	Front	
8745-1380L	BMW 1	Front	
	BMW 2-Series F45 F46	Front	
8745-1380R	BMW 1	Front	
	BMW 2-Series F45 F46	Front	
8745-1381L	BMW 3	Front	
	BMW 4	Front	
8745-1381R	BMW 3	Front	
	BMW 4	Front	
8745-1383	Volvo C90	Front	
8745-1388	Audi A3	Front	
	Seat Kodiaq	Front	
	Skoda Kodiaq	Front	
	Skoda Superb	Front	
	Volkswagen Golf 7	Front	
	Volkswagen Passat	Front	
	Volkswagen Tiguan	Front	
<b>8750-SERIES</b>			
8750-1001	Seat Arosa	Front	
	Seat Cordoba	Front	
	Seat Ibi a	Front	
	Seat Inca	Front	
	Volkswagen Caddy	Front	
	Volkswagen Commercials	Front	
	Volkswagen Lupo	Front	
	Volkswagen Polo	Front	
8750-1002	Audi A3	Front	
	Seat Leon	Front	
	Seat Toledo	Front	
	Skoda Octavia	Front	
	Volkswagen Bora	Front	
	Volkswagen Golf 4	Front	
	Volkswagen Jetta ( S markets only)	Front	
	Volkswagen Lavida	Front	

pe	Ma e Model	A le	
8750-1004	Volkswagen New Beetle Audi A2 Seat Cordoba Seat Ibi a Skoda Fabia Skoda Roomster Volkswagen Fox	Front Front Front Front Front Front	
8750-1005	Volkswagen Polo Audi A3 Seat Allea Seat Leon Seat Toledo Skoda Octavia Volkswagen Caddy Volkswagen Commercials Volkswagen Golf 5 Volkswagen Golf 6 Volkswagen Jetta ( S markets only) Volkswagen Jetta 5 Volkswagen Jetta 6 Volkswagen Scirocco	Front Front Front Front Front Front Front Front Front Front Front Front Front	
8750-1006	Audi A3 Seat Allea Seat Leon Seat Toledo Skoda Octavia Volkswagen Caddy Volkswagen Commercials Volkswagen Golf 5 Volkswagen Golf 6 Volkswagen Jetta 5 Volkswagen Jetta 6 Volkswagen Sagitar	Front Front Front Front Front Front Front Front Front Front Front Front Front	
8750-1008	Seat Toledo Volkswagen Golf 2 Volkswagen Golf 3 Volkswagen Jetta ( S markets only) Volkswagen Jetta 2 Volkswagen Vento	Front Front Front Front Front	
8750-1009	Seat Cordoba Seat Ibi a Volkswagen Corrado Volkswagen Golf 3 Volkswagen Jetta ( S markets only) Volkswagen Vento	Front Front Front Front Front Front	
8750-1010L	BMW 3-Series E36	Front	
8750-1010R	BMW 3-Series E36	Front	
8750-1011L	BMW 3-Series E36	Front	
8750-1011R	BMW 3-Series E36	Front	
8750-1012	Alfa Romeo GT Alfa Romeo 147 Alfa Romeo 156	Rear Rear Rear	
8750-1013L	Citroen C2	Front	
8750-1013R	Citroen C3	Front	
8750-1014L	Citroen C2 Citroen C3	Front Front	
8750-1014R	Citroen sara Citroen	Front Front	
8750-1014R	Peugeot 306 Citroen sara Citroen	Front Front Front	
8750-1015L	Peugeot 306 Peugeot 206	Front Front	
8750-1015R	Peugeot 206+ Peugeot 206	Front Front	
8750-1016L	Peugeot 206+ Peugeot 205	Front Front	
8750-1016R	Peugeot 309 Peugeot 205 Peugeot 309	Front Front Front	
8750-1018	Citroen C4	Front	
8750-1021	Peugeot 307 Opel Corsa Opel Tigra Vauxhall (See also Opel) Combo Vauxhall (See also Opel) Corsa Vauxhall (See also Opel) Nova Vauxhall (See also Opel) Tigra	Front Front Front Front Front Front Front Front	
8750-1023	Renault Clio	Front	
▲ 8750-1025L	Ford Europe Focus	Front	
▲ 8750-1025R	Ford Europe Focus	Front	
8750-1028L	Opel Astra Opel afira Vauxhall (See also Opel) Astra Vauxhall (See also Opel) afira	Front Front Front Front	
8750-1028R	Opel Astra Opel afira Vauxhall (See also Opel) Astra Vauxhall (See also Opel) afira	Front Front Front Front	
8750-1029L	BMW 3-Series E46	Front	
8750-1029R	BMW 3-Series E46	Front	
8750-1033	Scion Scion Toyota aris Echo Vit olden (Australia) Barina	Front Front Front	
8750-1034L	Opel Combo Opel Corsa	Front Front	

pe	Ma e Model	A le	
8750-1034R	Opel Tigra Vauxhall (See also Opel) Corsa Vauxhall (See also Opel) Tigra olden (Australia) Barina Opel Combo Opel Corsa Opel Tigra Vauxhall (See also Opel) Corsa Vauxhall (See also Opel) Tigra	Front Front Front Front Front Front Front Front Front Front	
8750-1035	Renault M gane	Front	
8750-1036	Fiat Bravo Brava	Front	
8750-1060	Volvo C70 Volvo S70 V70 Volvo 850	Front Front Front	
8750-1062	Audi S3 Audi TT Audi A3 Seat Leon Skoda Octavia Volkswagen Bora Volkswagen Golf 4 Renault Clio	Front Front Front Front Front Front Front Front	
8750-1063	Mercedes-Ben E-Class (W124) (C124) Mercedes-Ben 190-series (W201)	Front Front	
8750-1064	Fiat Punto	Front	
8750-1067	Lancia psilon	Front	
8750-1068	Peugeot 406 Peugeot 406	Front Front	
8750-1069L	BMW 5-Series E39	Front	
8750-1069R	BMW 5-Series E39	Front	
8750-1071	Alfa Romeo GTV Alfa Romeo Spider	Front Front	
8750-1074	Fiat Punto	Front	
8750-1075	Mercedes-Ben C-Class (W203) Mercedes-Ben CLC-Class (CL203) Mercedes-Ben CLK-Class (W209)	Front Front Front	
8750-1076	Mini New Mini	Front	
8750-1077	Mini New Mini	Front	
▲ 8750-1078L	Ford Europe Mondeo	Front	
▲ 8750-1078R	Ford Europe Mondeo	Rear	
8750-1079	Ford Europe Mondeo	Front	
8750-1080	Ford Europe Fiesta Ma da 2 (Demio)	Front Front	
8750-1081L	Ford Europe Fiesta Ma da 2 (Demio)	Front Front	
8750-1081R	Opel Signum Opel Vectra Opel Signum Opel Vectra	Front Front Front Front	
8750-1082L	BMW 1-Series E81 E82 E87 E88 BMW 3-Series E90 91 92 93	Front Front	
8750-1082R	BMW 1-Series E81 E82 E87 E88 BMW 3-Series E90 91 92 93	Front Front	
8750-1084L	Opel Astra Vauxhall (See also Opel) Astra	Front Front	
8750-1084R	Opel Astra Vauxhall (See also Opel) Astra	Front Front	
8750-1085L	Fiat Panda Fiat Panda	Front Front	
8750-1085R	Ford Australia Focus Ford Europe Focus Ma da 3 (Axela) Ford Australia Focus Ford Europe Focus Ma da 3 (Axela)	Front Front Front Front Front Front	
8750-1086L	Ma da 5 (Premacy)	Front	
8750-1086R	Volvo C30 Volvo C70 Volvo S40 V40 Volvo V50	Front Front Front Front	
8750-1087L	Ford Australia Focus Ford Europe Focus Ma da 3 (Axela) Ma da 5 (Premacy)	Front Front Front Front	
8750-1087R	Volvo C30 Volvo C70 Volvo S40 V40 Volvo V50	Front Front Front Front	
8750-1088L	Citroen C1 Peugeot 107 Peugeot 108 Toyota Aygo Citroen C1	Front Front Front Front Front	
8750-1088R	Peugeot 107 Peugeot 108 Toyota Aygo Citroen C1	Front Front Front Front	
8750-1090L	Peugeot 107 Peugeot 108 Toyota Aygo Renault Clio Renault Modus	Front Front Front Front Front	
8750-1090R	Opel Agila Su uki Splash Su uki Swift Vauxhall (See also Opel) Agila	Front Front Front Front	
8750-1091	Opel Agila	Front	
8750-1092L	Su uki Splash	Front	
8750-1092R	Su uki Splash	Front	

pe	Ma e Model	A le	🔧
8750-1093L	Su uki Swift Vauxhall (See also Opel) Agila Alfa Romeo MiTo Fiat Grande Punto	Front Front Front Front	
8750-1093R	Opel Corsa Alfa Romeo MiTo Fiat Grande Punto	Front Front Front	
▲ 8750-1094L	Opel Corsa	Front	
▲ 8750-1094R	Peugeot 207	Front	
8750-1110	Peugeot 207	Front	
8750-1112	Renault Clio	Front	
8750-1113L	Ford America Mustang	Front	
8750-1113R	Ford Europe Mustang	Front	
8750-1114	Ford Europe Mondeo Ford Europe Mondeo Audi A1	Front Front Front	
	Seat Ibi a Seat Toledo	Front Front	
	Skoda Fabia Skoda Rapid	Front Front	
	Volkswagen Polo Volkswagen Vento	Front Front	
8750-1115	Audi A3 Seat Leon Skoda Octavia	Front Front Front	
	Volkswagen Golf 7	Front	
8750-1116	BMW 1-Series F20 F21 BMW 2-Series F22 BMW 3-Series F30 F31 F34	Front Front Front	
	Audi TT	Front	
8750-1118	Mercedes-Ben C-Class (W204)	Front	
8750-1120L	Kia Rio III	Front	
8750-1120R	Kia Rio III	Front	
8750-1121L	Mercedes-Ben A-Class (W176), B-Class (W246) Mercedes-Ben CLA-Class (C117) Mercedes-Ben CLA-Class ( 117)	Front Front Front	
8750-1121R	Mercedes-Ben A-Class (W176), B-Class (W246) Mercedes-Ben CLA-Class (C117) Mercedes-Ben CLA-Class ( 117)	Front Front Front	
8750-1123	Audi A3 Seat Leon Skoda Octavia	Front Front Front	
	Volkswagen Golf 7	Front	
8750-1124L	Alfa Romeo Giulietta	Front	
8750-1124R	Alfa Romeo Giulietta	Front	
8750-1127L	Abarth 500 Fiat 500	Front Front	
	Ford Europe Ka Abarth 500	Front Front	
8750-1127R	Fiat 500 Ford Europe Ka	Front Front	
<b>88-SERIES</b>			
88-1686	Nissan Patrol	Front	PP
88-1687	Nissan Patrol	Rear	EE
88-1688	Toyota Landcruiser	Front	PP
88-1689	Toyota Landcruiser	Rear	PE
88-1711	Toyota Landcruiser	Front	PE
88-1712SP2	Toyota FJ Cruiser	Front	PE
	Toyota Landcruiser	Front	PE
88-1713	Toyota Australia i-Lux	Front	PE
	Toyota i-Lux	Front	PE
88-1719	Ford Australia F-series	Front	EE
88-1720	Ford Australia F-series	Rear	EE
88-1721	Ford Australia F-series	Rear	EE
88-1747	Toyota Landcruiser	Front	PE
88-1748	Toyota Landcruiser	Rear	PE
88-1794	Iveco DAIL IV V 4x4	Front	EE
88-1795	Iveco DAIL IV V 4x4	Rear	EE
88-1817	Ford Europe Ranger	Front	PE
	Ma da BT-50	Front	PE
88-1826	Mercedes-Ben Sprinter (W901) (W906)	Rear	EE
88-1830	Toyota Australia i-Lux	Front	PE
	Toyota Fortuner	Front	PE
	Toyota i-Lux	Front	PE
88-5389	Mitsubishi Pajero	Rear	PE
88-5390	Mitsubishi L200	Front	PE
	Mitsubishi Triton	Front	PE
88-5395	Isu u D-Max	Front	PE
88-5396	Fiat Fullback	Front	PE
	Mitsubishi L200	Front	PE
<b>8805-SERIES</b>			
8805-1055	Mercedes-Ben Sprinter (W901) (W906)	Rear	EE
	Volkswagen Commercial	Rear	EE
8805-1056	Mercedes-Ben Sprinter (W901) (W906)	Rear	EE
	Volkswagen Commercial	Rear	EE
8805-1057	Fiat Ducato (250 290)	Rear	EE
8805-1059	Fiat Ducato (250 290)	Rear	EE
8805-1061	Fiat Ducato (250 290)	Rear	EE
<b>90-SERIES</b>			
90-5370SP1	Nissan Patrol	Front	PP
90-5371SP1	Nissan Patrol	Rear	EE
90-5374SP1	Land Rover (Range-Rover) Discovery Land Rover (Range-Rover) Land Rover (Defender) Land Rover (Range-Rover) Range Rover	Front Front Front	PP PP PP

pe	Ma e Model	A le	🔧
90-5375SP1	Land Rover (Range-Rover) Discovery Land Rover (Range-Rover) Land Rover (Defender) Land Rover (Range-Rover) Range Rover	Rear Rear Rear	EP EP EP
90-5383	Mercedes-Ben G-Series (W460) (W461) (W463)	Front	EP
90-5384	Mercedes-Ben G-Series (W460) (W461) (W463)	Rear	PE
90-5389SP2	Lexus L Toyota Landcruiser	Front Front	PP PP
	Lexus L	Rear	PE
90-5390SP2	Toyota Landcruiser	Rear	PE
	Toyota Landcruiser	Rear	PE
90-5394	Toyota Landcruiser	Rear	PE
90-5397SP1	Toyota Landcruiser	Front	PE
90-5398SP1	Toyota Landcruiser	Rear	PE
90-5401	Land Rover (Range-Rover) Discovery Land Rover (Range-Rover) Land Rover (Defender) Land Rover (Range-Rover) Range Rover	Rear Rear Rear	EP EP EP
90-5404LSP1	Toyota FJ Cruiser Toyota Landcruiser	Rear Rear	PE PE
90-5404LSP2	Toyota FJ Cruiser	Rear	PE
	Toyota Landcruiser	Rear	PE
90-5404RSP1	Toyota FJ Cruiser	Rear	PE
	Toyota Landcruiser	Rear	PE
90-5404RSP2	Toyota FJ Cruiser	Rear	PE
	Toyota Landcruiser	Rear	PE
90-5410SP1	Toyota Australia i-Lux Toyota i-Lux	Rear Rear	EE EE
90-5441	Toyota Landcruiser	Front	PP
90-5442	Toyota Landcruiser	Rear	EE
90-5443	Mitsubishi Pajero	Front	PE
90-5447SP1	Toyota Landcruiser	Front	PE
90-5448	Toyota Landcruiser	Rear	PE
90-5450	Nissan Navara	Front	PE
90-5451	Nissan Navara	Rear	EE
90-5458	Fiat Fullback Isu u D-Max	Rear Rear	EE EE
	Mitsubishi L200	Rear	EE
	Mitsubishi Triton	Rear	EE
90-5474	Ford Europe Ranger Ma da BT-50	Rear Rear	EE EE
90-5476	Nissan Navara	Front	PE
90-5477	Nissan Navara	Rear	EE
90-5478	Mercedes-Ben -Class (W470)	Rear	EE
	Nissan Navara	Rear	EE
90-5479	Toyota Australia i-Lux Toyota i-Lux	Rear Rear	EE EE
<b>9905-SERIES</b>			
9905-1003	Land Rover (Range-Rover) Discovery	Front	PE
9905-1004	Land Rover (Range-Rover) Discovery	Rear	PE

art Number	Application	Year	A le	
<b>8045-SERIES</b>				
8045-1021	Alfa Romeo 147 Alfa Romeo 156 Alfa Romeo GT	00-05.10 10.97-06 01.04-07.10	Front Front Front	
8045-1068	Ford Australia Focus Ford Europe Focus	06.05-11 11.04-11 11-12.14 15-18 01.09-13	Rear Rear Rear Rear Rear	
8045-1070	Ma da 3 (Axela) Volvo C30 Audi A1 Audi A2 Seat Cordoba Seat Ibi a	07-14 08.10-18 00-05 09.02-08 04.02-08 08-17 10-17 01.00-07 10.07-14 12.06-14 15-19 05-11 09-09.17 11.01-06.09	Rear Rear Rear Rear Rear Rear Rear Rear Rear Rear Rear Rear	
8045-1083	Skoda Fabia  Volkswagen Fox Volkswagen Polo	01.00-07 10.07-14 12.06-14 15-19 05-11 09-09.17 11.01-06.09	Rear Rear Rear Rear Rear Rear Rear	
8045-1084	Audi A3 Seat Leon Seat Toledo Skoda Octavia  Volkswagen Bora Volkswagen Golf 4 Volkswagen Jetta ( S markets only) Volkswagen Lavida Audi A3	09.96-03 99-05 99-04 00-04 01.97-05.04 06.98-05.04 11.98-05 10.97-03 99-03 08-12 05.03-12	Rear Rear Rear Rear Rear Rear Rear Rear Rear Rear Rear Rear	
8045-1085	Seat Altea Seat Leon Seat Toledo Skoda Octavia  Volkswagen Golf 5  Volkswagen Golf 6  Volkswagen Jetta 5 Seat Alhambra Skoda Superb	04-15 09.05-12.12 05.04-09 05-12 05-09 07-09 10.03-08 10.04-08 08-12 09-13 11-13 05-10 10-19	Rear Rear	
8045-1096	Volkswagen Golf 5 Volkswagen Golf 6 Volkswagen Jetta ( S markets only) Volkswagen Jetta 6  Volkswagen Magotan  Volkswagen Passat  Volkswagen Sharan Volkswagen Touran	08-05.15 09-05.15 05-08 09.09-12 05-10 10-17 07-13 10-13 01.08-17 03.05-14 04.07-14 08.05-14 10-19 03-08.10 09.10-05.15	Rear Rear	
8045-1097	Ford Australia Focus Ford Europe Focus  Ma da 3 (Axela) Volvo S40 V40 Volvo V50	06.05-11 10.03-11.10 10.05-11 01.09-13 04-12 04-12	Rear Rear Rear Rear Rear Rear	
8045-1160	Ma da 3 (Axela) Ma da 5 (Premacy)  olden (Australia) Vectra Opel Vectra Saab 9-5  Saturn LS LW Vauxhall (See also Opel) Vectra	03-12.08 06-12.08 05-10 10-17 96-02 96-03.02 09.01-04.10 97-08.01 00-05 96-02	Rear Rear	
8045-1222	Audi A4  Audi A5  Audi A6 Audi A7	03.08-15 07-15 07-15 09-15 11-18 10-18	Rear Rear Rear Rear Rear Rear	

art Number	Application	Year	A le	
8045-1226	Audi A3  Seat Leon Skoda Octavia Volkswagen Golf 5 Volkswagen Golf 6	01.08-12 05.03-12 06-12.12 06-12 04-08	Rear Rear Rear Rear Rear	
8045-1228	Volkswagen Jetta 6 Volkswagen New Beetle  Volkswagen Scirocco Audi Q3 Volkswagen Tiguan	09-12 01.13-18 10.11-18 03.08-11.17 11-18 07-16	Rear Rear Rear Rear Rear Rear	
8045-1232	Mini New Mini	01-02.02 03.02-06	Rear Rear	
8045-1246	Audi A4	04.01-07 11.00-07	Rear Rear	
8045-1248	Seat Exeo Abarth 500 Fiat 500 Ford Europe Ka	09-13 07-19 07-19 08-12.15	Rear Rear Rear Rear	
8045-1265	Audi A4 Audi A5  Audi A6 Audi A7 Audi S4 Audi S5	03.09-15 10.08-13 03.07-15	Rear Rear Rear Rear Rear Rear	
8045-1296	Mercedes-Ben C-Class (W204)	07-13	Rear	
8045-1335	Nissan Qashqai  Nissan -Trail Renault Kadjar	07-13 14-19 07.07-10.13 15-19	Rear Rear Rear Rear	
8045-1347	Ma da C -5	12-06.17	Rear	
8045-1377	onda CR-V	01.12-16	Rear	
8045-1378	Mercedes-Ben E-Class (W212)	01.09-16	Rear	
8045-1379	Mercedes-Ben C-Class (W205)	12.13-19	Front	
8045-1380	Mercedes-Ben C-Class (W205)	12.13-19	Rear	
<b>8050-SERIES</b>				
8050-1128	Audi TT	06-13	Rear	PE
8050-1141	Audi A4  Audi A5	03.08-15 07-15 03.09-15	Rear Rear Rear	PE PE PE
8050-1142	Audi A6 Audi A7 Audi A4 Audi A5 Audi A6 Audi A7	07-15 09-15 11-18 10-18 Rear Rear Rear Rear	Rear Rear Rear Rear Rear Rear Rear Rear	PE PE PE PE PE PE
8050-1143	Mercedes-Ben C-Class (W204)	07-13	Rear	
8050-1144	Kia Rio III	12-17	Rear	
8050-1145	Mercedes-Ben A-Class (W176), B-Class (W246) 13-16 Mercedes-Ben CLA-Class (C117) Mercedes-Ben CLA-Class ( 117)	01.13-18 15-18	Rear Rear Rear	PE PE PE
8050-1146	Abarth 500 Fiat 500 Ford Europe Ka	07-19 07-19 08-12.15	Rear Rear Rear	
<b>8205-SERIES</b>				
8205-1006	Fiat Ducato (250 290)	07.06-	Rear	EE
8205-1008	Fiat Ducato (250 290)		Rear	EE
8205-1009	Volkswagen California Multivan Volkswagen Commercial	03-15 15-19	Rear Rear	EE EE
<b>8240-SERIES</b>				
8240-1316	Fiat Fullback Mitsubishi L200	15-19 15-19	Front Front	
8240-1318	Fiat Fullback Mitsubishi L200	15-19 15-19	Rear Rear	
<b>8241-SERIES</b>				
8241-1304Sport	Fiat 124 Ma da M -5	03.16-	Front Front	
8241-1305Sport	Fiat 124 Ma da M -5	03.16-	Rear Rear	



art Number	Application	Year	A le	
<b>8245-SERIES</b>				
8245-1004	BMW 5-Series E6	06.03-11.09	Rear	
8245-1008	Audi A4	04.01-07 11.00-07 09-13	Front Front Front	
8245-1011	Seat Exeo Cadillac BLS	03.06-08 07-08 10.08-09	Rear Rear Rear	
	Saab 9-3	03.05-07 08.03-07 08-11 10.02-07	Rear Rear Rear Rear	
8245-1015	BMW 1-Series E81 E82 E87 E88	09.04-11	Rear	
8245-1017	BMW 3-Series E90 91 92 93 Volvo 850 Volvo C70 Volvo S70 V70	05-11 92-97 97-05 97-99	Rear Rear Rear Rear	
8245-1023	BMW 3-Series E46	98-05	Rear	
8245-1024	BMW 3-Series E46		Rear	
		05.99-05 06.01-05 98-05	Rear Rear Rear	
8245-1032	Audi A3	98-99 99-03	Rear Rear	
	Audi S3 Seat Leon Volkswagen Bora	99-06.03 99-05 00-02 00-04 99-00	Rear Rear Rear Rear Rear	
	Volkswagen Golf 4	00-03 04.99-99 99-03 99-04	Rear Rear Rear Rear	
8245-1041	BMW 5-Series E6	06.03-10	Rear	
8245-1042L	Kia Sorento	02-05	Front	
8245-1042R	Kia Sorento	02-05	Front	
8245-1043	Kia Sorento	02-05	Rear	
8245-1054	BMW 5-Series E39		Rear	
		12.95-03	Rear	
8245-1056	BMW 5-Series E39	03.97-04	Rear	
8245-1094	BMW 3-Series E90 91 92 93	05-11 06-11 07-11	Rear Rear Rear	
		05-16	Rear	
8245-1175	Su uki Vitara	06-12.12	Rear	
8245-1177	Toyota RAV4	06.06-04.09	Rear	
8245-1178	Kia Sorento	01.11-04.15	Rear	
8245-1190L	Mini New Mini	10.06-06.14 11.05-11.13	Rear Rear	
		12.10-05.15	Rear	
8245-1190R	Mini New Mini	01.11-04.15 10.06-06.14 11.05-11.13 12.10-05.15	Rear Rear Rear Rear	
8245-1195L	Kia Sorento	06.06-04.09	Front	
8245-1195R	Kia Sorento	06.06-04.09	Front	
8245-1221	Audi A4	03.08-15 07-15	Front Front	
	Audi A5	03.09-15 07-15 09-15	Front Front Front	
8245-1223	Jeep Commander	05-10	Front	
	Jeep Grand Cherokee	05-11	Front	
8245-1224	Jeep Commander	05-10	Rear	
	Jeep Grand Cherokee	05-11	Rear	
8245-1251	Porsche 911 (912)	01.91-09.93 08.90-09.93	Rear Rear	
8245-1253L	Porsche 911 (912)	03.95-09.97 10.93-09.97	Rear Rear	
8245-1253R	Porsche 911 (912)	03.95-09.97 10.93-09.97	Rear Rear	
8245-1255	Porsche 911 (912)	06.00-08.05 09.97-08.05	Rear Rear	
8245-1256	Ford Europe Mondeo Volvo S60 V60 Volvo S70 V70 Volvo S80	03.07-14 10-18 03.07-16 03.06-16	Rear Rear Rear Rear	
8245-1264	Audi A4 Audi A5 Audi A6 Audi A7 Audi Q5 Audi S4 Audi S5		Front Front Front Front Front Front Front	
		09.08-16 10.08-13 03.07-15	Front Front Front	
8245-1294	Audi A6 Audi A7	11-18 10-18	Front Front	
8245-1302L	BMW 5-Series F	09-17	Front	
8245-1302R	BMW 5-Series F	09-17	Front	
8245-1303	BMW 5-Series F	09-17	Rear	
8245-1308	Volvo C60	05.08-17	Rear	
8245-1310	BMW 3	03-10	Rear	
8245-1319	BMW 1-Series F20 F21	10.11-18	Rear	

art Number	Application	Year	A le	
	BMW 2-Series F22 BMW 3-Series F30 F31 F34		11.10-19 11-18 12-18	Rear Rear Rear
8245-1320	BMW 5-Series F		09-17	Rear
8245-1322	Toyota Prius		06.09-15	Rear
8245-1326	Audi A3			Rear
	Seat Leon		12-18	Rear
	Skoda Octavia		01.13-18	Rear
	Volkswagen Golf 7		01.13-19	Rear
			01.13-06.19 05.13-06.19 11.12-06.19	Rear Rear Rear
8245-1327	Audi A3			Rear
			12-18 14-18 14-19	Rear Rear Rear
	Seat Leon Skoda Octavia Volkswagen Golf 7			Rear Rear Rear
			01.13-06.19 05.13-06.19 11.12-06.19 14-06.19	Rear Rear Rear Rear
8245-1343L	BMW 5 BMW 6		07-13 08-14	Rear Rear
8245-1343R	BMW 5 BMW 6		07-13 08-14	Rear Rear
8245-1357	BMW 1-Series F20 F21 BMW 2-Series F22 BMW 3-Series F30 F31 F34		10.11-18 11.10-19 11-18 12-18 10.12-19	Rear Rear Rear Rear Rear
8245-1359	BMW 4-Series (F32 F33 F36) yundai Santa Fe Kia Sorento		09.09-06.12 09-12.12	Rear Rear
8245-1363	yundai Santa Fe Kia Sorento		07.12-18 01.12-12.14	Rear Rear
8245-1376	Mini New Mini		04.13-19 09.13-19	Rear Rear
8245-1377	Volvo C70		08.07-16	Rear
8245-1378	Nissan Qashqai Renault Kadjar		14-19 15-19	Rear Rear
8245-1379	yundai Santa Fe Kia Sorento		07.12-18 01.12-11.14	Rear Rear
8245-1380	BMW 2-Series F45 F46 BMW 1		14-19 11.14-	Rear Rear
8245-1381	BMW 3 BMW 4		10-17 14-19	Rear Rear
8245-1383	Volvo C90		02-09.14	Rear
8245-1385	BMW 4-Series (F32 F33 F36)		04.13-19	Rear
8245-1387	Seat Kodiaq Skoda Kodiaq Skoda Superb Volkswagen Passat		10.16-19 10.16- 03.15- 01.15-19	Rear Rear Rear Rear
	Volkswagen Tiguan Nissan Navara		15-19 16-19 01.15-19	Rear Rear Front
8245-1395				





art Number	Application	Year	A le	🔑
<b>8750-SERIES</b>				
8750-1113L	Ford Europe Mondeo	15-19	Front	
8750-1113R	Ford Europe Mondeo	15-19	Front	
8750-1114	Audi A1	08.10-18	Front	
	Seat Ibi a	08-17	Front	
		10-17	Front	
	Seat Toledo	13-18	Front	
	Skoda Fabia	15-19	Front	
	Skoda Rapid	12-18	Front	
	Volkswagen Polo	09-09.17	Front	
		10-09.17	Front	
8750-1115	Volkswagen Vento	10-18	Front	
	Audi A3		Front	
		01.14-18	Front	
		12-18	Front	
	Seat Leon	01.13-18	Front	
	Skoda Octavia		Front	
		01.13-19	Front	
	Volkswagen Golf 7		Front	
		01.13-06.19	Front	
		05.13-06.19	Front	
		11.12-06.19	Front	
8750-1116	BMW 1-Series F20 F21	10.11-18	Front	
	BMW 2-Series F22	11.10-19	Front	
	BMW 3-Series F30 F31 F34	11-18	Front	
		12-18	Front	
8750-1118	Audi TT		Front	
		06-13	Front	
8750-1119	Mercedes-Ben C-Class (W204)	07-13	Front	
8750-1120L	Kia Rio III	12-17	Front	
8750-1120R	Kia Rio III	12-17	Front	
8750-1121L	Mercedes-Ben A-Class (W176), B-Class (W246)	13-18	Front	
	Mercedes-Ben CLA-Class (C117)	01.13-18	Front	
	Mercedes-Ben CLA-Class ( 117)	15-18	Front	
8750-1121R	Mercedes-Ben A-Class (W176), B-Class (W246)	13-18	Front	
	Mercedes-Ben CLA-Class (C117)	01.13-18	Front	
	Mercedes-Ben CLA-Class ( 117)	15-18	Front	
8750-1123	Audi A3		Front	
		01.14-18	Front	
		12-18	Front	
	Seat Leon		Front	
	Skoda Octavia		Front	
	Volkswagen Golf 7		Front	
		05.13-06.19	Front	
8750-1124L	Alfa Romeo Giulietta	10-19	Front	
8750-1124R	Alfa Romeo Giulietta	10-19	Front	
8750-1127L	Abarth 500	07-19	Front	
	Fiat 500	07-19	Front	
	Ford Europe Ka	08-12.15	Front	
8750-1127R	Abarth 500	07-19	Front	
	Fiat 500	07-19	Front	
	Ford Europe Ka	08-12.15	Front	
<b>87-SERIES</b>				
87-2661	Mercedes-Ben Sprinter (W901) (W906)	02.08-18	Front	
<b>8805-SERIES</b>				
8805-1055	Mercedes-Ben Sprinter (W901) (W906)	06.06-18	Rear	E E
	Volkswagen Commercials	06-10.16	Rear	E E
8805-1056	Mercedes-Ben Sprinter (W901) (W906)	06.06-18	Rear	E E
	Volkswagen Commercials	06-10.16	Rear	E E
8805-1057	Fiat Ducato (250 290)	07.06-	Rear	E E
8805-1059	Fiat Ducato (250 290)		Rear	E E
8805-1061	Fiat Ducato (250 290)		Rear	E E
<b>88-SERIES</b>				
88-1712SP2	Toyota FJ Cruiser	06-16	Front	P E
	Toyota Landcruiser		Front	P E
		06-16	Front	P E
88-1794	Iveco DAIL IV V 4x4	05.06-02.14	Front	E E
88-1795	Iveco DAIL IV V 4x4	05.06-02.14	Rear	E E
88-1817	Ford Europe Ranger	11-19	Front	P E
	Ma da BT-50	10.11-19	Front	P E
88-1826	Mercedes-Ben Sprinter (W901) (W906)	02.08-18	Rear	E E
88-1830	Toyota Australia i-Lux	15-	Front	P E
	Toyota Fortuner	07.15-19	Front	P E
	Toyota i-Lux		Front	P E
88-5396	Fiat Fullback	15-19	Front	P E
	Mitsubishi L200	15-19	Front	P E

art Number	Application	Year	A le	🔑
<b>90-SERIES</b>				
90-5404LSP1	Toyota FJ Cruiser	06-16	Rear	P E
	Toyota Landcruiser		Rear	P E
		06-16	Rear	P E
90-5404LSP2	Toyota FJ Cruiser		Rear	P E
	Toyota Landcruiser		Rear	P E
90-5404RSP1	Toyota FJ Cruiser	06-16	Rear	P E
	Toyota Landcruiser		Rear	P E
		06-16	Rear	P E
90-5404RSP2	Toyota FJ Cruiser		Rear	P E
	Toyota Landcruiser		Rear	P E
90-5410SP1	Toyota Australia i-Lux	05-14	Rear	E E
	Toyota i-Lux	05-14	Rear	E E
90-5474	Ford Europe Ranger	11-19	Rear	E E
	Ma da BT-50	10.11-19	Rear	E E
90-5476	Nissan Navara		Front	P E
90-5478	Mercedes-Ben -Class (W470)	09.17-	Rear	E E
	Nissan Navara		Rear	E E
90-5479	Toyota Australia i-Lux	15-	Rear	E E
	Toyota i-Lux		Rear	E E
<b>9905-SERIES</b>				
9905-1003	Land Rover (Range-Rover) Discovery	04-09.09	Front	P E
		10.09-16	Front	P E
9905-1004	Land Rover (Range-Rover) Discovery	04-09.09	Rear	P E
		10.09-16	Rear	P E
<b>-SERIES</b>				
I.D.	Audi A4	05.15-	Front	
			Rear	
	Audi Q2	06.16-	Front	
			Rear	
	BMW 2	11.17-	Front	
			Rear	
	Dacia Duster	10-17	Rear	
	Ford Europe Fiesta	03.13-	Front	
			Rear	
		11.12-12.16	Front	
	Ford Europe Focus	15-18	Front	
	Mercedes-Ben V-Class (W638) (W639) (W447)		Front	
			Rear	
		10.14-	Front	
			Rear	
	Mercedes-Ben -Class (W470)	09.17-	Front	
	Porsche Boxster	11.04-12	Front	
			Rear	
	Porsche Cayman	11.05-12.13	Front	
			Rear	
	Renault Alaskan	09.17-	Front	
			Rear	
	Seat Arona	07.17-	Front	
			Rear	
	Seat Ateca	05.16-	Front	
			Rear	
	Seat Ibi a	01.17-	Front	
			Rear	
	Skoda Karoq	07.17-	Front	
			Rear	
	Subaru Impre a	15-	Front	
			Rear	
	Subaru WR	15-	Front	
			Rear	
	Toyota Fortuner	07.15-19	Rear	
	Volkswagen Arteon	04.17-	Front	
			Rear	
	Volkswagen Polo	06.17-	Front	
			Rear	
	Volkswagen T-Roc	07.17-	Front	
			Rear	

# NOTES

---

---

---

---

---

---

---

---

---

---

---

---

---

---

---

---

---

---

---

---

---

---

---

---

---

---

---

---

---

---





## SIGNES

F

- Ⓒ Amortisseur à pression de gaz
- Ⓛ Surbaissement approximatif en mm
- ☛ CLASSIC couleur noir
- ☛ CLASSIC couleur rouge
- ☞ Réglage de l'extérieur à l'aide d'une molette.  
Ou d'une tige sans dépose des amortisseurs du véhicule Filetage.
- Ⓝ Sauf système autonivelant
- ┌ Amortisseur avec course réduite spécialement étudié pour utilisation avec ressorts courts.  
Voir exemple SPORT-SHORT.
- ▲ Sera annulé après épuisement du stock.
- △ Pour raisons techniques, impossibilité d'équipement.
- ⊕ Ferrures de montage nécessaires.
- ☐ Avant de régler, retirer la butée en caoutchouc du cache-poussière.
- ◆ Cartouche de remplacement spéciale se fixant par le fond de la jambe de force d'origine après découpe du sertissage et dépose des pièces internes.

I.D. En développement

- ③ ① N4 ② 8041-1154 Sport  
Dessin encerclé=nombre de gorges. 2 gorges, espace 20 mm, la gorge du haut est standard.

## ② La gorge du bas est standard

- M0 gorge de clip inférieure 7 mm plus bas
- M1 gorge de clip inférieure 10 mm plus bas
- M2 gorge de clip inférieure 15 mm plus bas
- M3 gorge de clip inférieure 20 mm plus bas
- M4 gorge de clip inférieure 25 mm plus bas
- M5 gorge de clip inférieure 30 mm plus bas

## ② La gorge du haut est standard

- N1 gorge de clip inférieure 7 mm plus bas
- N2 gorge de clip inférieure 10 mm plus bas
- N3 gorge de clip inférieure 15 mm plus bas
- N4 gorge de clip inférieure 20 mm plus bas
- N5 gorge de clip inférieure 25 mm plus bas
- N6 gorge de clip inférieure 30 mm plus bas

## ③ La gorge du haut est standard

- P1 gorge de clip inférieure 5 mm plus bas
- P2 gorge de clip inférieure 6 mm plus bas
- P3 gorge de clip inférieure 7 mm plus bas

## ③ La gorge du milieu est standard

- R1 distance entre chaque gorge 6 mm
- R2 distance entre chaque gorge 10 mm
- R3 distance entre chaque gorge 15 mm
- R4 distance entre chaque gorge 20 mm
- R5 distance entre chaque gorge 25 mm
- R6 gorge supérieure 25 mm plus haut
- R7 gorge de clip inférieure 15 mm plus bas

## ⑤ La gorge du milieu est standard

- T1 distance entre chaque gorge 7 mm
- T2 distance entre chaque gorge 10 mm
- T3 distance entre chaque gorge 12 mm

## SONDERZEICHEN

D

- Ⓒ Gasdruckdämpfer
- Ⓛ Ungefähre Tieferlegung in mm
- ☛ CLASSIC schwarze Farbe
- ☛ CLASSIC rote Farbe
- ☞ Mit Hilfe eines Einstellknopfes im eingebauten Zustand von außen nachstellbar.
- Ⓝ Außer Niveauregulierung
- ┌ Spezialanfertigung (mit verkürztem Ausfederweg /Rebound) zur Verwendung mit Tieferlegungsfedern.  
Siehe Beispiel Sport Short!
- ▲ Auslaufftyp! Solange Vorrat reicht.
- △ Aus technischen Gründen ist die Montage von KONI Stoßdämpfern oder Load-a-Juster nicht möglich.
- ⊕ Zusätzliche Anbauteile erforderlich .
- ☐ Gummipuffer aus der Staubkappe entfernen.  
Erst dann nachstellbar.
- ◆ McPherson-Federbein-Patrone für gefalzte Federbeine.  
Befestigung am Boden des Original Federbeines mit Gewindebolzen. Das Federbein wird hierzu geöffnet, die Innenteile entfernt und durch eine Patrone ersetzt.

I.D. In Entwicklung

- ③ ① N4 ② 8041-1154 Sport  
2 Nuten, Abstand 20 mm, obere Nut = Standardhöhe.  
Die Zahl im Kreis stellt die Anzahl der Nuten dar.

## ② Untere Nut = Standard

- M0 obere Nut 7 mm höher
- M1 obere Nut 10 mm höher
- M2 obere Nut 15 mm höher
- M3 obere Nut 20 mm höher
- M4 obere Nut 25 mm höher
- M5 obere Nut 30 mm höher

## ② Obere Nut = Standard

- N1 untere Nut 7 mm tiefer
- N2 untere Nut 10 mm tiefer
- N3 untere Nut 15 mm tiefer
- N4 untere Nut 20 mm tiefer
- N5 untere Nut 25 mm tiefer
- N6 untere Nut 30 mm tiefer

## ③ Obere Nut = Standard

- P1 untere Nut je 5 mm tiefer
- P2 untere Nut je 6 mm tiefer
- P3 untere Nut je 7 mm tiefer

## ③ Mittlere Nut = Standard

- R1 obere/untere Nut je 6 mm Abstand
- R2 obere/untere Nut je 10 mm Abstand
- R3 obere/untere Nut je 15 mm Abstand
- R4 obere/untere Nut je 20 mm Abstand
- R5 obere/untere Nut je 25 mm Abstand
- R6 obere Nut 25 mm höher
- R7 untere Nut 15 mm tiefer

## ⑤ Mittlere Nut = Standard

- T1 obere/untere Nut je 7 mm Abstand
- T2 obere/untere Nut je 10 mm Abstand
- T3 obere/untere Nut je 12 mm Abstand

## NOTAS

E

- Ⓒ Con gas
- Ⓛ Descenso aprox. en mm
- ☛ CLASSIC color negro
- ☛ CLASSIC color rojo
- ☞ Regulable exteriormente por medio de tapón.  
O pasador, sin tener que desmontar los amortiguadores del vehículo.
- Ⓝ Sin sistema autonivelante.
- ┌ Amortiguadores específicamente diseñados (con la carrera acortada para usar con muelles bajos).
- ▲ Se dejará de suministrar cuando se agoten los stocks.
- △ Por motivos técnicos no es posible colocar amortiguadores telescópicos o Load-a-juster.
- ⊕ Piezas adicionales requeridas, coma abrazaderas.
- ☐ Antes de ajustar, sacar el tope de goma de la cubierta antipolvo.
- ◆ Cartucho especial Mc-Pherson para carcasas selladas, fijado al fondo después de cortar la carcasa y quitar las piezas internas originales.

I.D. En desarrollo

- ③ ① N4 ② 8041-1154 Sport  
La figura en el círculo = número de ranuras. 2 anuras, distancia 20 mm, la ranura superior es estándar.

## ② La ranura inferior es estándar

- M0 ranura superior 7 mm más alta
- M1 ranura superior 10 mm más alta
- M2 ranura superior 15 mm más alta
- M3 ranura superior 20 mm más alta
- M4 ranura superior 25 mm más alta
- M5 ranura superior 30 mm más alta

## ② La ranura superior es estándar

- N1 ranura inferior 7 mm más baja
- N2 ranura inferior 10 mm más baja
- N3 ranura inferior 15 mm más baja
- N4 ranura inferior 20 mm más baja
- N5 ranura inferior 25 mm más baja
- N6 ranura inferior 30 mm más baja

## ③ La ranura superior es estándar

- P1 ranura inferior 5 mm más baja
- P2 ranura inferior 6 mm más baja
- P3 ranura inferior 7 mm más baja

## ③ La ranura intermedia es estándar

- R1 ranura superior/inferior a 6 mm de distancia
- R2 ranura superior/inferior a 10 mm de distancia
- R3 ranura superior/inferior a 15 mm de distancia
- R4 ranura superior/inferior a 20 mm de distancia
- R5 ranura superior/inferior a 25 mm de distancia
- R6 ranura superior 25 mm más alta
- R7 ranura inferior 15 mm más baja

## ⑤ La ranura intermedia es estándar

- T1 ranura superior/inferior a 7 mm de distancia
- T2 ranura superior/inferior a 10 mm de distancia
- T3 ranura superior/inferior a 12 mm de distancia



- Ⓞ Gas-charged shock absorber.
- Ⓣ Approx. lowering in mm.
- ⚙ CLASSIC color black.
- ⚙ CLASSIC color red.
- ⚙ Externally adjustable by means of a knob or pin without removing the shock absorbers from the car.
- Ⓝ Excludes self-leveling systems.
- Ⓛ Specially designed dampers (with shortened stroke) for use with lowering springs.
- ▲ Will be discontinued when current stock is depleted.
- △ Fitting of KONI telescopic shock absorbers or load adjusters is not possible for technical reasons.
- + Additional parts, like brackets, required.
- Remove bump rubber from dust cover before adjusting.
- ◆ Special McPherson insert, for sealed struts, bolted to the bottom after cutting the housing and removal of original inner parts. To be used in original struts only.
- I.D. In Development

Example

N4 b  8041-1154 Sport  
 2 grooves, distance 20 mm, top groove is standard.  
 The figure in the circle = number of grooves.

- ②  Bottom groove is standard
- M0 top groove 7 mm higher
- M1 top groove 10 mm higher
- M2 top groove 15 mm higher
- M3 top groove 20 mm higher
- M4 top groove 25 mm higher
- M5 top groove 30 mm higher

- ②  Top groove is standard
- N1 bottom groove 7 mm lower
- N2 bottom groove 10 mm lower
- N3 bottom groove 15 mm lower
- N4 bottom groove 20 mm lower
- N5 bottom groove 25 mm lower
- N6 bottom groove 30 mm lower

- ③  Top groove is standard
- P1 bottom groove 5 mm lower
- P2 bottom groove 6 mm lower
- P3 bottom groove 7 mm lower

- ③  Middle groove is standard
- R1 top/bottom groove each on 6 mm distance
- R2 top/bottom groove each on 10 mm distance
- R3 top/bottom groove each on 15 mm distance
- R4 top/bottom groove each on 20 mm distance
- R5 top/bottom groove each on 25 mm distance
- R6 top groove 25 mm higher
- R7 bottom groove 15 mm lower

## Note for BMW 3-series E30 up to August 1988 with "M-Technik"

If equipped with "M" sportpack (Bilstein), the following original parts are required to fit the KONI insert: Bumpstop part no. 31-331-124-449, Dustcover part no. 31-331-134-314 (31-331-124-510), Locking nut part no. 31-321-115-398 (McPherson housing Ø 45 mm) or Locking nut part no. 31-321-117-376 (McPherson housing Ø 51 mm).

## Axle loads

In order to choose the correct KONI STR.T KIT or KONI SPORT KIT with the correct characteristics and amount of lowering for your vehicle, maximum axle loads as indicated by the vehicle manufacturer may be of importance. Maximum axle loads are in some countries mentioned on the vehicle documents, but can also be found in the car itself. Every vehicle carries a vehicle identification plate (metal plate or sticker), usually located in the engine compartment or on a door sill. Various information and weights are shown, needed are the fields marked with "1" and "2":

1 - Maximum front axle load

2 - Maximum rear axle load

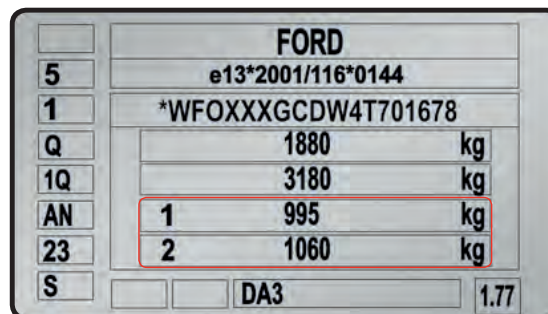

## Important kit notes

- 1 The amount of lowering will be reduced on vehicles fitted with Original Sport Suspension /OEM
- 2 The lowering of the front axle depends on the vehicle specification and weight of the engine.
- 3 For fine tuning, please refer to the original Daimler Benz spring isolators available in different heights (8-23mm).
- 4 A TÜV certificate is necessary despite ABE for vehicles with a 'load dependant' brake power distributor.
- 5 Sedan without self-leveling, Estate/Station Wagon/Combi with self-leveling.
- 6 Additional lowering may occur on vehicles equipped with automatic transmissions.
- 7 Not for Station Wagons/Combi/Estates
- 8 Up to 8.79 please use spring seat no. 171412341A.
- 9 Excludes 4-wheel drive
- 10 As of 9.94 original Volkswagen springs seats might be necessary: 1H0412341 (big) or 357412341 A (small).
- 11 Not suitable for Serial/Original Sport Suspension (OEM)
- 12 Front springs only, torsion bars on the rear axle.
- 13 All wheel/tire combinations are allowed which have been approved by the ABE or other certified Wheel Testing Institutes (Germany, Austria, Switzerland).
- 14 If RH drive shaft diameter is bigger than 42 mm and when lowering 40 mm or more, the RH driveshaft may foul the anti-roll bar. If so you will need to fit a modified anti-roll bar or a longer steering rod from your VW/Audi dealer.
- 15 Excludes self-leveling.
- 16 Front & rear dampers are externally adjustable
- 17 Front dampers are externally adjustable
- 18 Rear dampers are externally adjustable
- 19 Rear dampers must be removed from car before they can be adjusted
- 20 excl. Cooper "S"
- 21 Front: threaded housing with adjustable spring seat
- 22 Rear: threaded housing with adjustable spring seat
- 23 Rear: ride height adjustable (adapter)
- 24 Rear: not ride height adjustable
- 25 With cars up to 5.92 the upper attachment must be replaced by BMW part number 31.331.090.467
- 26 Will be discontinued when current stock is depleted



For complete catalogue visit  
[www.koni.com/finder](http://www.koni.com/finder)

SINCE 1857 | [koni.com](http://koni.com)

